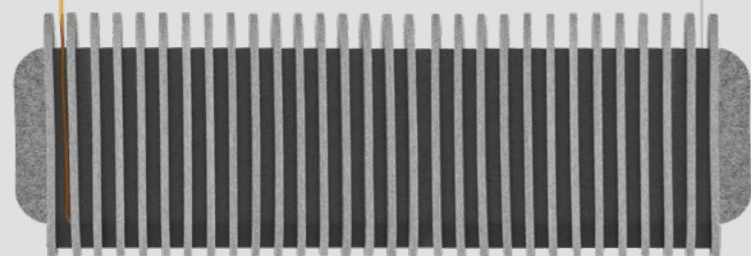

80
PET
BOTTLESup to
3m²
ACOUSTIC
SURFACE

Fold

EN The Fold is a pendant lamp that is both a professional light source and a high sound-absorbing acoustic panel. The lamp is equipped with a powerful and energy-efficient linear light fitting. It is only 28 mm wide and incorporates an additional dark optic shutter. The professional quality of the light makes it perfect for office spaces. The high acoustic performance of the lamp makes it a perfect match for demanding spaces. When hung above a desk in an open-office type space, it creates optimal working conditions. It is made from ecoPET – synthetic felt panels manufactured from recycled PET bottles. ecoPET is non-flammable and is characterised by high durability and easy maintenance. It is created from recycled material and is possible to be recycled again.

DE Die Fold ist eine Pendelleuchte, die sowohl eine professionelle Lichtquelle als auch ein hochschallabsorbierendes Akustikpaneel ist. Die Leuchte ist mit einer leistungsstarken und energieeffizienten Linearleuchte ausgestattet. Es ist nur 28mm breit und verfügt über einen zusätzlichen Dark-Optic-Shutter. Die professionelle Qualität des Lichts macht es perfekt für Büroräume. Die hohe akustische Leistung der Lampe macht sie zu einer perfekten Ergänzung für anspruchsvolle Räume. Über einem Schreibtisch in einem Großraumbüro aufgehängt, schafft er optimale Arbeitsbedingungen. Es besteht aus ecoPET – synthetischen Filz, der aus recycelten PET-Flaschen hergestellt wird. ecoPET ist nicht brennbar und zeichnet sich durch hohe Haltbarkeit und einfache Pflege aus. Es wird aus recyceltem Material hergestellt und kann wieder recycelt werden.

Example

Fold
↑
2125 - 00 - 2 - 8 - 4 - 01 - 20 - 2 - archi1201
↓
one size DALI luminaire black 9005 pendant

standard power 4000K dark optics 65° with black reflector ARCHI felt color 1201 Cloud

Quickinfo

luminaire size	1250×400×120
light source size	1134×28
system power	↓19.6W*
luminous flux	↓2234lm*
UGR	<19

Technical information

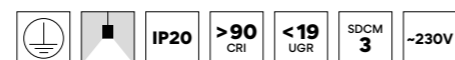

light distribution - down	120° opal			
	60° microprismatic			
	65° dark optics			
	55° dark optics			
luminous efficiency	LO	ST	HI	
	65°	118lm/W	113lm/W	108lm/W *
	55°	117lm/W	112lm/W	107lm/W *
electrical control	ON/OFF		▲ 9	
	DALI		▲ 8	
color temperature	3000K		● 3	
	4000K		● 4	
	on request: TUNABLE WHITE		● 9	
luminaire color	black 9005		● 01	
	white 9010		● 02	
optics	opal		* 10	
	microprismatic		* 11	
	dark optics 65° (black reflector)		* 20	
	dark optics 65° (white reflector)		* 21	
	dark optics 65° (silver reflector)		* 22	
	dark optics 55° (black reflector)		* 23	
dark optics 55° (white reflector)		* 24		
	dark optics 55° (silver reflector)		* 25	
fabric color	ARCHI felt ecoPET color palette archixxx – choose color from page 266		◆ archixxx	

* Photometric data: dark optics 65°, white reflector, 4000K

Create my unique code!

2125 - 00 - ~ - ▲ - ● - ◆ - * - 2 - ◆

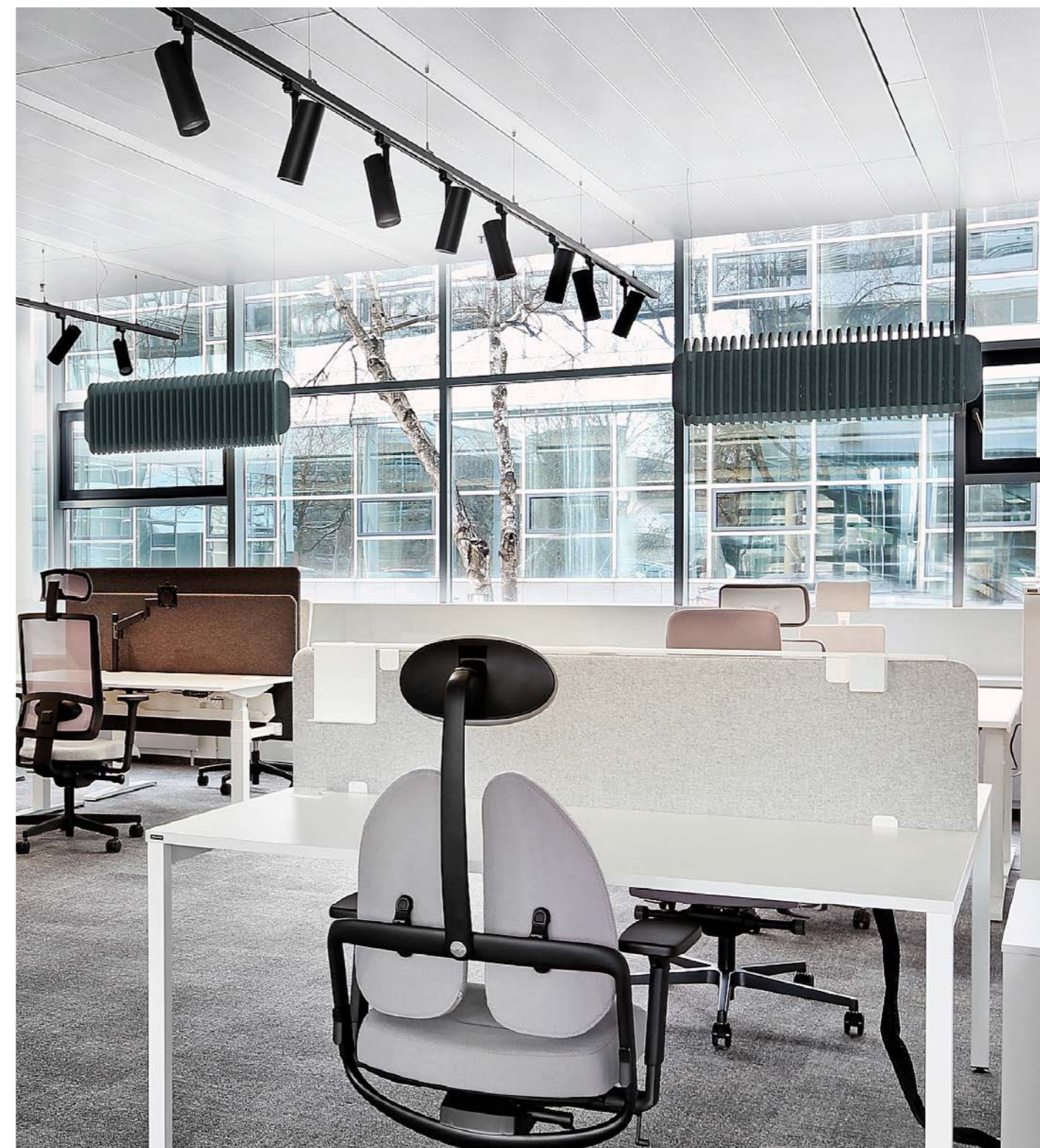

SHOWROOM MUNICH KUSCH+CO NOWY STYL

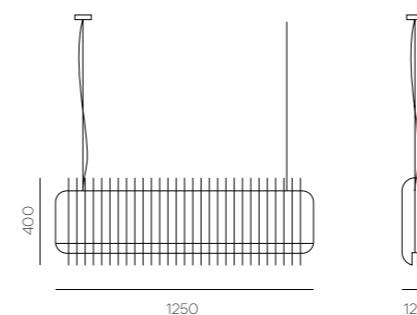

On request we can produce it in other sizes!

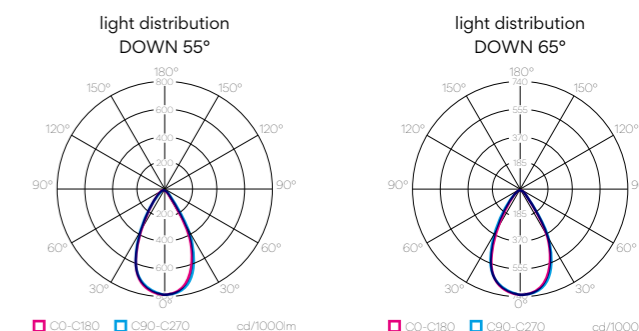

ARCHI felt ecoPET 12 mm

EN The high-quality PET sound panels are robust, durable, and have a slightly textile surface that can be washed. They have excellent sound-absorbing properties, are flame-resistant and recyclable.

DE Hochwertige PET-Akustikplatten sind massiv, strapazierfähig, mit einer leicht textilen Oberfläche, die gewaschen werden kann. Sie haben hervorragende Schalldämmeigenschaften, sind schwer entflammbar und können recycelt werden.

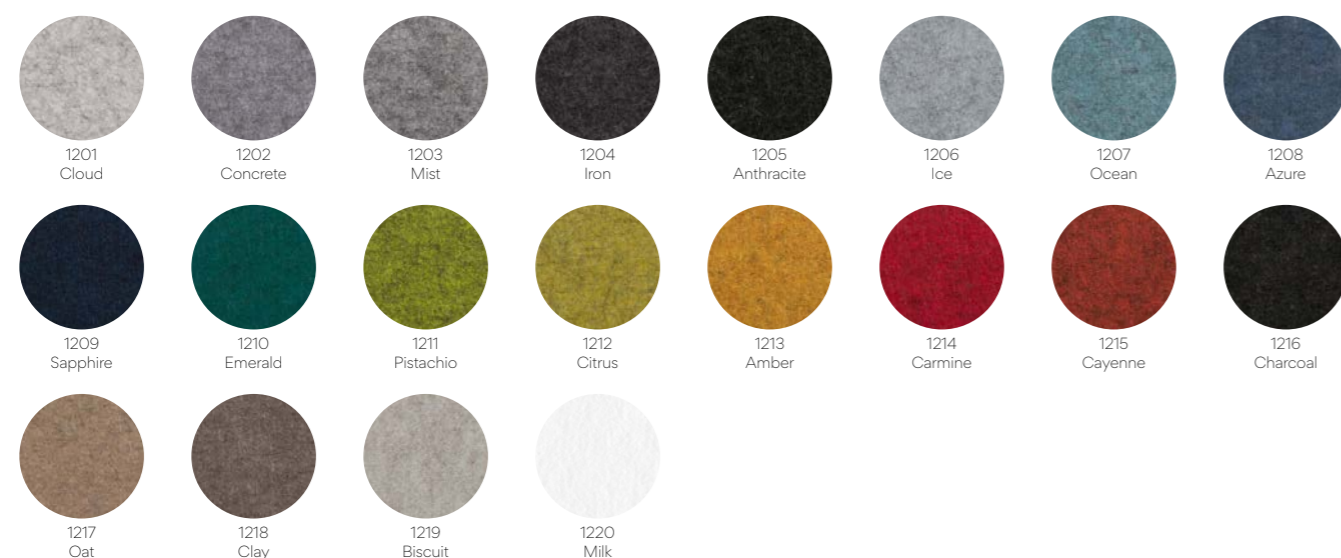

ARCHI felt ecoPET properties

Measurements

2800 mm × 1200 mm × 12 mm

gross size

Flammability Class

B-s1,d0

Acoustic values

Mounting method	Directly on the wall	50 mm cavity	50 mm cavity + 50 mm rockwool	100 mm cavity	100 mm cavity + 100 mm rockwool
NRC (100–5000 Hz)	0.40	0.75	0.95	0.80	1.00
aw (100–5000 Hz)	0.25	0.60	1.00	0.80	0.95
Acoustic Class	D	C	A	B	A

Flexxica wool felt 5 mm

EN Flexxica wool felt color palette is high-quality 5 mm thick felt. Wool felt has many technical uses, including, among others, in acoustics. The natural properties of wool make this felt not only look designer but also absorb noise and sound perfectly.

DE Die Farbpalette von Flexxica Wollfilz ist hochwertiger 5 mm dicker Filz. Wollfilze haben viele technische Anwendungen, u. a. in der Akustik. Die natürlichen Eigenschaften der Wolle verleihen diesem Filz nicht nur ein Design-Look, sondern auch eine perfekte Dämpfung von Lärm und Geräuschen.



Flexxica felt 5 mm

EN Flexxica felt color palette is a wide range of flame-retardant design felts with a velour finish and high noise reduction properties. They are available in many colors, ideal for many decorative projects, including upholstery and interiors.

DE Die flexxica-Farbpalette für Filze ist eine große Auswahl an schwer entflammaren Designfilzen mit Velours-Finish und hohen Geräuschminderungseigenschaften. Sie sind in vielen Farben erhältlich, ideal für viele dekorative Projekte, einschließlich Polsterung und Innenausstattung.

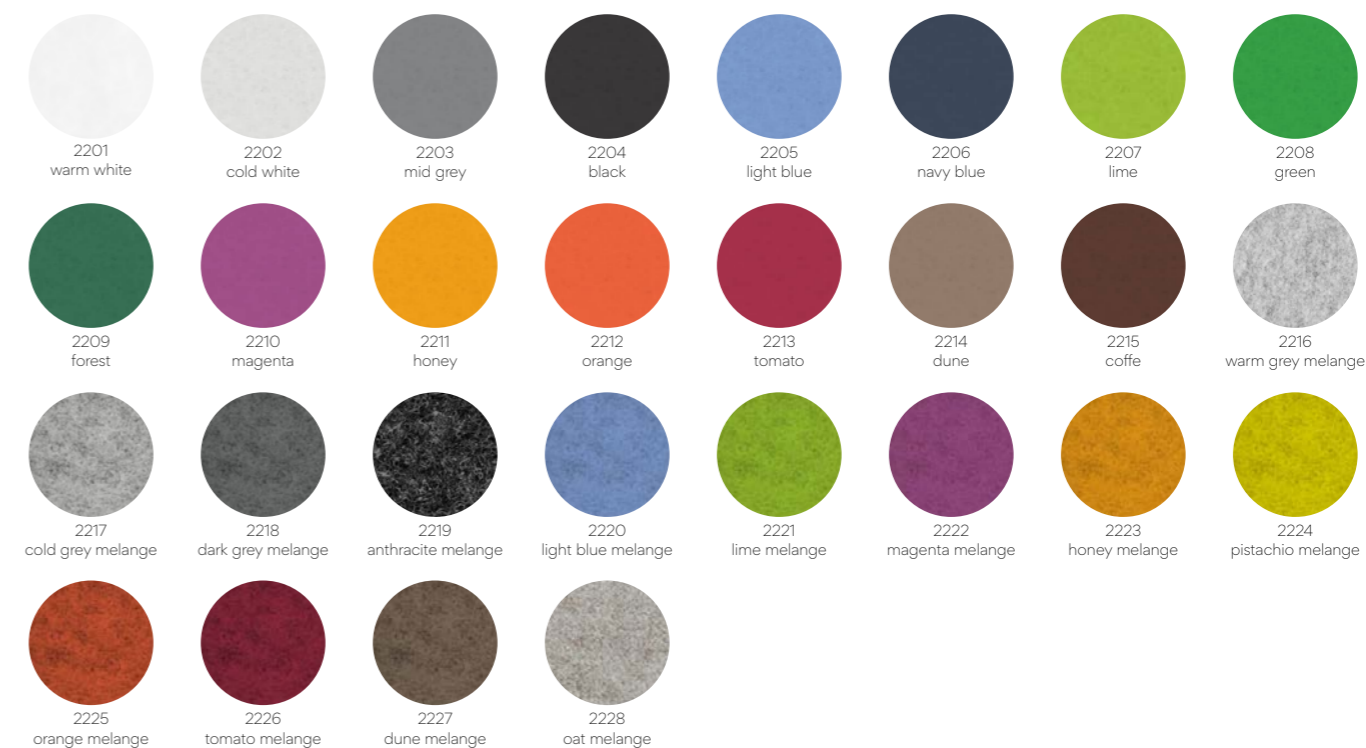

Guidelines for cleaning and maintenance of materials used in flexxica luminaires.

To maintain the beautiful color and appearance of flexxica lighting fittings, we recommend gentle vacuuming with a soft tip, preferably weekly.

Stain removal – the golden rule

Remove the stain as soon as possible. Most stains can be removed with lukewarm water, possibly with the addition of a neutral detergent.

Merino wool felt

Wool is antistatic and does not attract dirt like other fabrics. Wool is also water-repellent, so the liquids slowly penetrate the fabric.

Cleaning: First, soak up as much liquid as possible with a white kitchen towel or cloth. If the stain has dried, remove as much as possible with a vacuum cleaner. Wipe carefully with a clean white cloth.

Upholstered material

Upholstery in flexxica luminaires is highly versatile and durable. The material is antistatic and fireproof, so stains are easily removed.

Cleaning: Do not wet the entire lampshade. Always use a clean white cotton cloth and only use small amounts of cleaning agent at a time.

EcoPET material

The ecoPET is made of 60% recycled PET bottles. It is straightforward to maintain, and stains can be removed easily and hassle-free.

Cleaning: Never rub hard to remove a stain. Always use a clean white cotton cloth with a bit of detergent.

Glass luminaires

Boya is made in a traditional blown-glass technology, therefore it requires special and delicate cleaning care.

Cleaning: Use a soft, lint-free microfiber or cotton cloth with distilled water (optimal) or mild glass cleaner or a solution of equal parts water and white vinegar. Wipe carefully with a clean white cloth.

WARNING!

Benzene, acetone, and similar solvent-based products may discolor the materials of the flexxica luminaires. Before use, apply a small amount of the product to an inconspicuous spot to ensure it doesn't cause any damage or discoloration.

flexxica

ul. Szyszkowa 43
02-285 Warsaw
Poland / European Union

+48 723 06 30 30
hello@flexxica.com
flexxica.com

PHOTOGRAPHY

Dominika Rutkowska
Ernest Wińczyk
Fotomohito
Patryk Lewiński
PION Studio
Szymon Polański

Copyright 2024 flexxica®

The flexxica® logo is a national and international registered trademark, held and owned exclusively by PL sp. z o.o. It cannot be reproduced or used, for commercial or other purposes, without the prior written permission of flexxica. This catalog cancels and replaces all previous editions. Flexxica has ensured that the information contained in this catalog is as accurate as possible; however, it declines all responsibility for any printing errors. Flexxica reserves the right to make modifications and improvements of a technical or aesthetic nature to the products at any time without notice. The reproduction (even partial) of this catalog, for any reason and with any means, is prohibited without the prior written permission of flexxica.

Please note that the actual appearance of flexxica's felt and fabric lighting fixtures may vary from the images shown in the catalog. This is because each type of felt and fabric possesses its own distinct characteristics. This is not a disadvantage of the luminaire but an advantage – each product is unique and unrepeatable.

Keep in mind that the colors of PET, felts, and fabric may differ slightly from what you see in the catalog. For the most accurate representation, we recommend referring to our sample book.

Due to the production process of both felt and PET, there may be slight variations in material between different production batches. Additionally, please take into consideration that PET boards have distinct left and right sides, along with a specific fiber arrangement. This is particularly important to consider when installing larger structures, such as wall-mounted panels.

Graphic Design: emenem.pl

Paper: Arctic Volume White 115g

Cover: Color STYLE Recycling 270g

Typeface: Gordita

Printed in Poland