

flexxica

lighting & acoustics

2024

fluora.ch
INDIVIDUELLE LICHTLÖSUNGEN



Scan the QR code
and plan your next office lighting
with flexxica luminaires.

Contents

Lighting & Acoustics **4**

Acoustic Lighting

ecoPET **32**

felt **110**

fabric **132**

air **158**

Lighting

design **160**











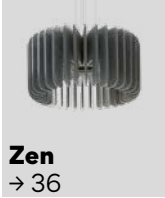
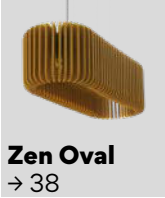

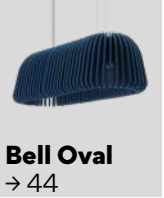

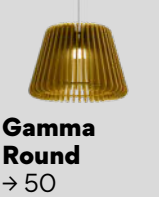



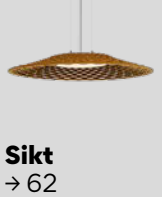
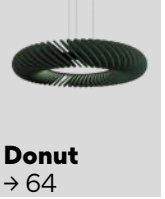
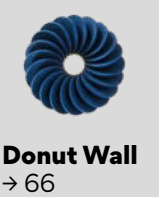
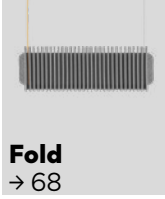

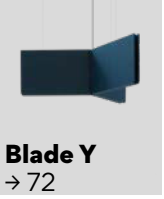
professional **196**

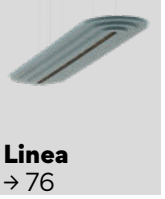
Acoustic accessories **232**

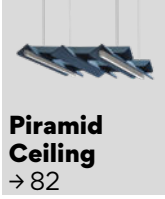



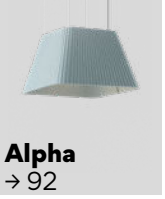
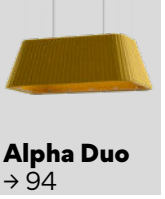
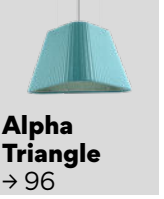
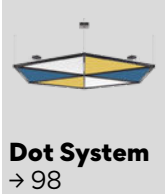

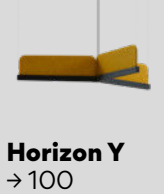
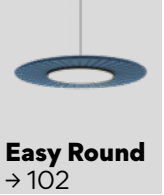
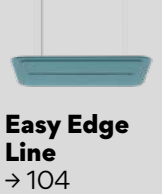
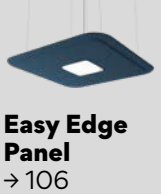
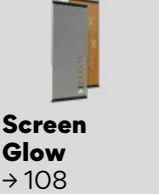
Color palettes **264**

Acoustic Lighting

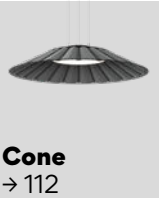
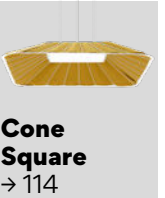

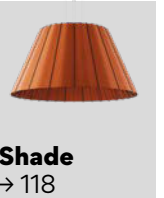

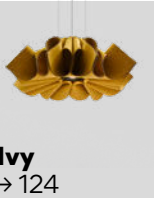

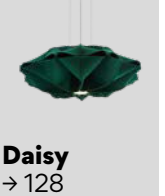
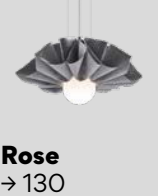

ecoPET

 Zen → 36	 Zen Oval → 38	 Bell → 42	 Bell Oval → 44	 Bell Wall → 46	 Bell Floor 2.0 → 48	 Gamma Round → 50
 Gamma Square → 52	 Sol → 56	 Sol Square → 58	 Sol Wall → 60	 Sikt → 62	 Donut → 64	 Donut Wall → 66
 Fold → 68	 Blade 2.0 → 70	 Blade X → 72	 Blade Y → 72	 Hillock 2.0 → 74	 Linea → 76	 Cone PET → 78
 Pyramid Ceiling → 82	 Simple Ceiling 2.0 → 84	 Systema Ceiling → 86	 Verti Ceiling 2.0 → 90	 Alpha → 92	 Alpha Duo → 94	 Alpha Triangle → 96
 Dot System → 98	 Horizon X → 100	 Horizon Y → 100	 Easy Round → 102	 Easy Edge Line → 104	 Easy Edge Panel → 106	 Screen Glow → 108

felt

 Cone → 112	 Cone Square → 114	 Team → 116	 Shade → 118	 Quadro → 120	 Ivy → 124	 Lily → 126
 Daisy → 128	 Rose → 130					

fabric

 Roller → 134	 Roller Floor → 138	 Cubber → 136	 Ring → 140	 Square → 142	 Round → 144	 Island → 146
 Gap Round → 148	 Gap Triangle → 150	 Gap Island → 152	 Gaya → 154	 Sphere → 156		

air

 Panel → 158
--

Lighting

design

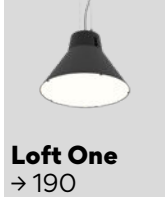
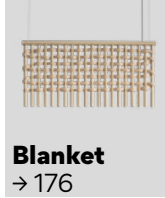
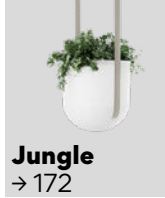

professional

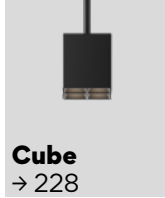
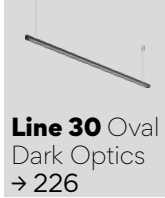
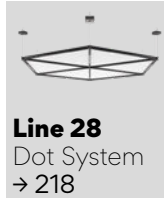
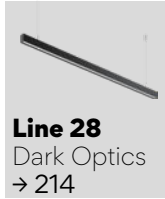
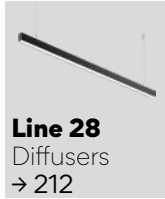
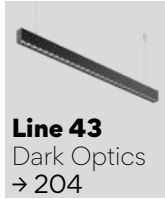

Acoustics

accessories

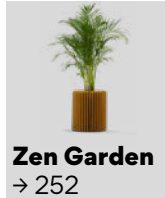
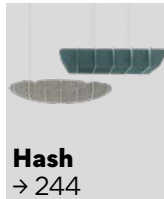
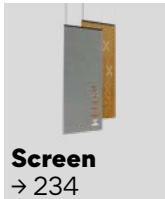

Welcome to flexxica lighting & acoustics

EN The functionality, design, and outstanding quality of our components coupled with the exquisite craftsmanship of every lighting fixture are the essence of our brand. Each flexxica luminaire has been meticulously designed by carefully analyzing what contemporary office life looks like, which is constantly evolving and changing today. Our goal is to create originally designed, and high-quality lighting fixtures in different styles that perfectly suit all types of office spaces. And we do this well, which is why flexxica luminaires have often been appreciated and awarded at the most important design competitions in Europe.

DE Die Funktionalität, das Design und die herausragende Qualität unserer Komponenten gepaart mit der exquisiten Handwerkskunst jeder Leuchte sind das Wesen unserer Marke. Jede flexxica Leuchte wurde sorgfältig entworfen, indem genau analysiert wurde, wie das heutige Büroleben aussieht, das sich ständig weiterentwickelt und verändert. Unser Ziel ist es, originell entworfene und hochwertige Leuchten in verschiedenen Stilen zu schaffen, die perfekt zu allen Arten von Büroflächen passen. Und das machen wir auch gut, weshalb die flexxica Leuchten bei den wichtigsten Designwettbewerben in Europa vielfach geschätzt und ausgezeichnet werden.



We create
originally
designed and
high-quality
lighting fixtures.



ERGO GDANSK TRZOP ARCHITEKCI

Award winning luminaires

Zen

page 36 – 39



Bell

page 42

DESIGN PLUS
powered by light+building
2022



Sol

page 56 – 59



Screen Glow

page 108



Cone

page 112



Ivy

page 124



Wire Medusa

page 162



reddot winner 2021

Boya

page 166



reddot winner 2021

Jungle

page 172



Team System

page 116 180



reddot winner 2021
best of the best



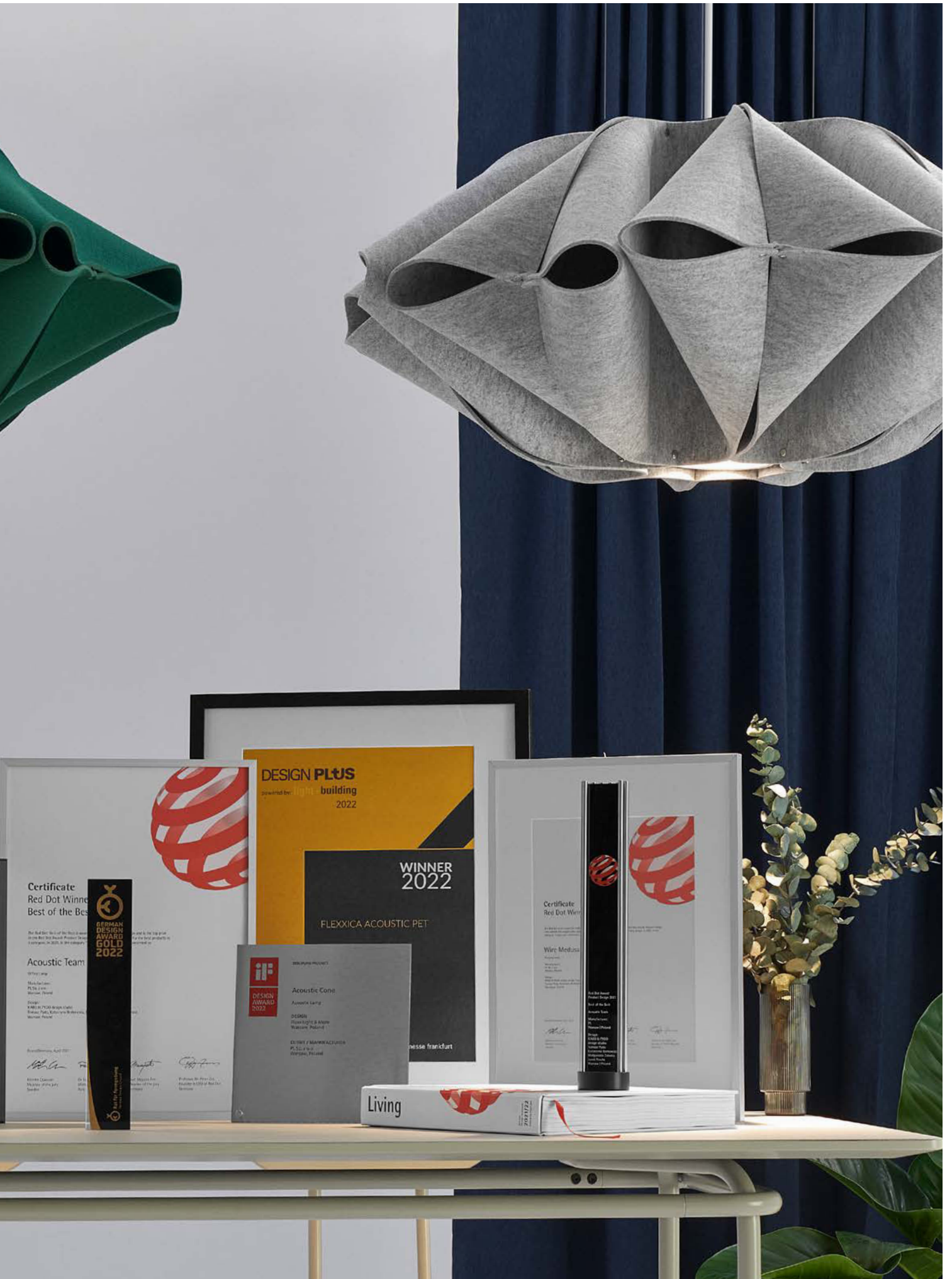

Size does matter

EN We are very flexible, and each of our projects is different and requires tailored solutions. We have a wide range of luminaires in various sizes, including XXL solutions for particularly large rooms.

DE Wir sind sehr flexibel und jedes unserer Projekte ist anders und erfordert individuelle Lösungen. Wir haben ein breites Sortiment an Leuchten in verschiedenen Größen, bis hin zu XXL-Lösungen für besonders große Räume.



ING KATOWICE MAŁECCY BIURO PROJEKTOWE



Good workplace
acoustics are
attainable!

The office lighting of tomorrow today

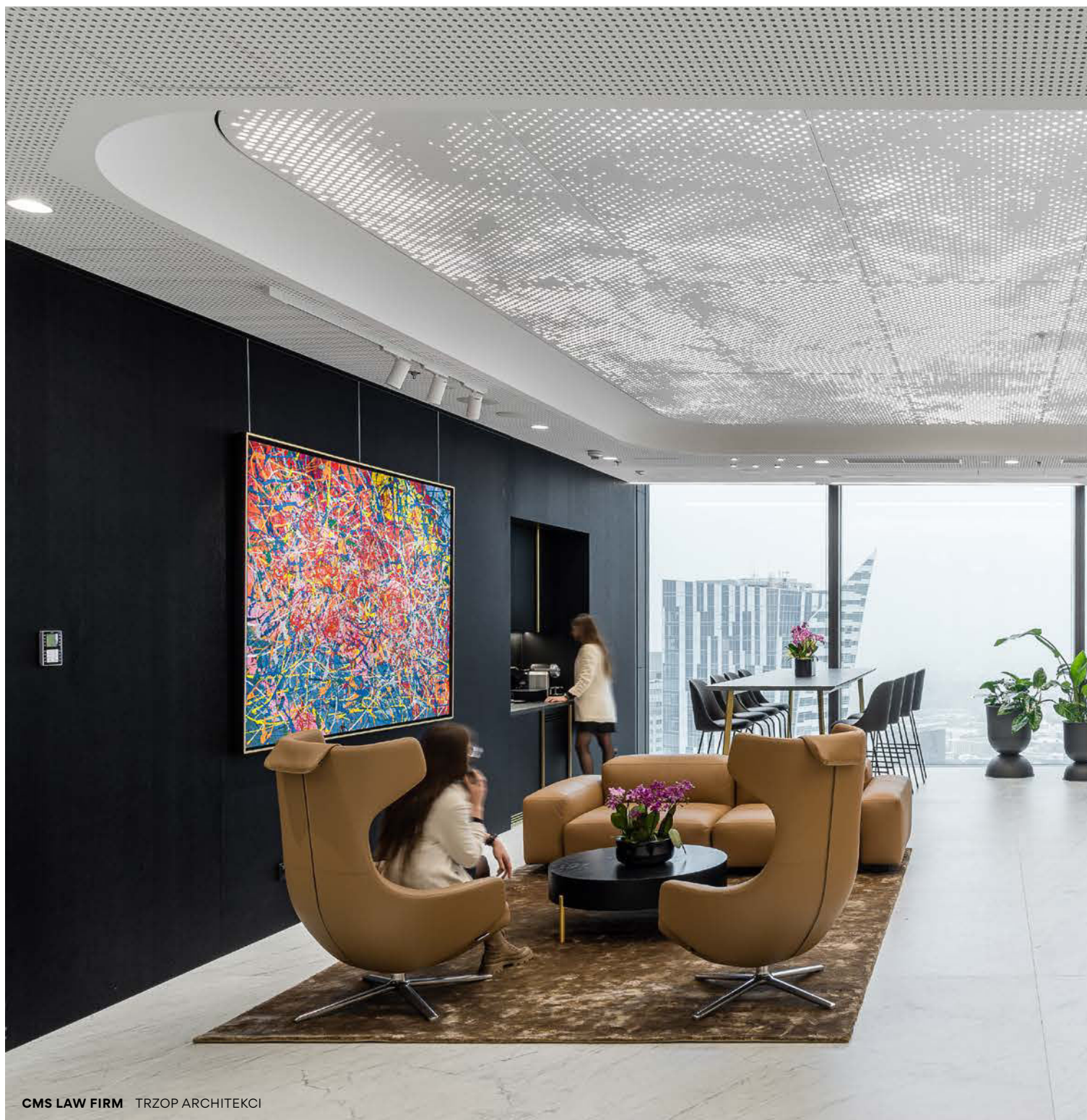

CMS LAW FIRM TRZOP ARCHITEKCI

EN The way we work today has changed dramatically. We work in open-plan spaces, guest lounges, conference rooms, and online while participating in video conferences, webinars, and online training sessions. It is time to align your office lighting infrastructure with high-quality light sources. Flexxica lighting solutions customize them to your needs in order to maximize space utility, employee acoustic comfort, productivity and safety, improve the flexibility of the office area, and lower the carbon footprint.

DE Die Art und Weise, wie wir heute arbeiten, hat sich dramatisch verändert. Wir arbeiten in offenen Räumen, Gästelounges, Konferenzräumen und online, sowie nehmen an Videokonferenzen, Webinaren und Online-Schulungen teil. Es ist an der Zeit, Ihre Bürobeleuchtung mit hochwertigen Lichtquellen auszurichten. Flexxica-Beleuchtungslösungen passen sie an Ihre Bedürfnisse an, um den Raumnutzen, den akustischen Komfort, die Produktivität und Sicherheit der Mitarbeiter zu maximieren, und die Flexibilität des Bürobereichs zu verbessern und den CO2-Fußabdruck zu verringern.



It is time to align your office lighting with high-quality light sources.

We care

EN The journey towards sustainable transformation is one we must take together. We focus on how sustainable practices, and specifically the reduction of carbon emissions, can benefit both our business and the environment. Minimizing our carbon footprint is one of the main goals of sustainable manufacturing in flexxica, and intelligent solutions like Tunable White can potentially help achieve some of our carbon targets. We also digitalize production to increase efficiency and improve sustainability in lighting manufacturing.



DE Der Weg zu einem nachhaltigen Wandel ist einer, den wir gemeinsam gehen müssen. Wir konzentrieren uns darauf, wie nachhaltige Praktiken und insbesondere die Reduzierung von CO₂-Emissionen sowohl unserem Geschäft als auch der Umwelt zugutekommen können. Die Minimierung unseres CO₂-Fußabdrucks ist eines der Hauptziele der nachhaltigen Fertigung in flexxica, und intelligente Lösungen wie Tunable White können möglicherweise dazu beitragen, einige unserer CO₂-Ziele zu erreichen. Wir digitalisieren auch die Produktion, um die Effizienz zu steigern und die Nachhaltigkeit in der Beleuchtungsherstellung zu verbessern.

Sustainable manufacturing
for minimizing our
carbon footprint.



Eco-friendly

Take a look at the flexxica sustainable supply chain

Circularity & After-sales
repair, recycling, and upcycling
of used and unsold products,
remote maintenance

Circularity & After-Sales
Reparatur, Recycling und
Upcycling von gebrauchten
und nicht verkauften
Produkten, Fernwartung



Inventory Management
intelligent warehouse
operations: building
materials, lights-out

Bestandsführung
intelligenter
Lagerbetrieb: Baustoffe,
Lichtausfall

Product design and R&D
digital prototyping, circular
product design, low-tech
product, and durable materials

Produktdesign und F&E
digitales Prototyping,
kreisförmiges Produktdesign,
Low-Tech-Produkt und
langlebige Materialien

Distribution
route and packaging
optimization and prescriptive
supply chain analytics

Vertrieb
Routen- und
Verpackungsoptimierung
sowie präskriptive Analyse
der Lieferkette

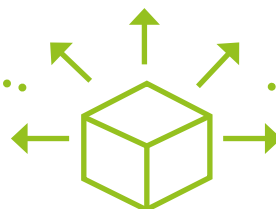

Sourcing
certification schemes to
measure the environmental
footprint of input materials

Beschaffung
Zertifizierungssysteme zur
Messung des ökologischen
Fußabdrucks von
Einsatzmaterialien

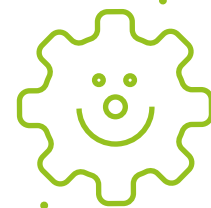

Production
low-energy processes
using renewables, recycling
of production waste, and
recyclable packing

Produktion
Niedrigenergieprozesse mit
erneuerbaren Energien, Recycling
von Produktionsabfällen und
wiederverwertbare Verpackungen

EcoPET

Take action for a more sustainable and prosperous tomorrow with flexxica.

EN ARCHI felt ecoPET is the material that we use to produce every luminaire from the Acoustic ecoPET series. It is made from collected, compressed, shredded, and melted recycled plastic bottles to produce plastic fibers, which are pressed together in layers to make a sturdy sheet of ARCHI felt ecoPET.

DE ARCHI felt ecoPET ist das Material, aus dem wir jede Leuchte der Serie Acoustic ecoPET fertigen. Es wird aus gesammelten, komprimierten, zerkleinerten und geschmolzenen recycelten Kunststoffflaschen hergestellt, um Kunststofffasern herzustellen, die in Schichten zusammengepresst werden, um eine stabile ARCHI felt ecoPET-Platte herzustellen.

What are the advantages of using flexxica ecoPET in our acoustic lighting?

Welche Vorteile bietet der Einsatz von flexxica ecoPET in unserer akustischen Beleuchtung?



is fire resistant to prevent the spread of fire

ist feuerbeständig, um die Ausbreitung von Feuer zu verhindern



does not degrade, crumble or rot

degradiert, zerbröselt oder verrottet nicht



is durable and easy to clean

ist langlebig und leicht zu reinigen



has a favorable sustainability profile (compared to glass and aluminum)

hat ein günstiges Nachhaltigkeitsprofil (im Vergleich zu Glas und Aluminium)



provides excellent sound absorption properties

bietet ausgezeichnete Schallabsorptionseigenschaften



does not contain VOCs or formaldehyde binders

enthält keine VOCs oder Formaldehydbindemittel



is made from recycled plastic bottles and is fully recyclable again

wird aus recycelten Plastikflaschen hergestellt und ist vollständig wiederverwertbar

312
PET
BOTTLES



up to
11.76 m²
ACOUSTIC
SURFACE

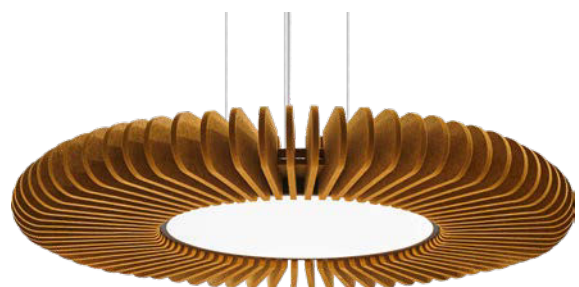

flexxica ecoPET luminaire

Acoustic balance



Absorptive acoustic solutions

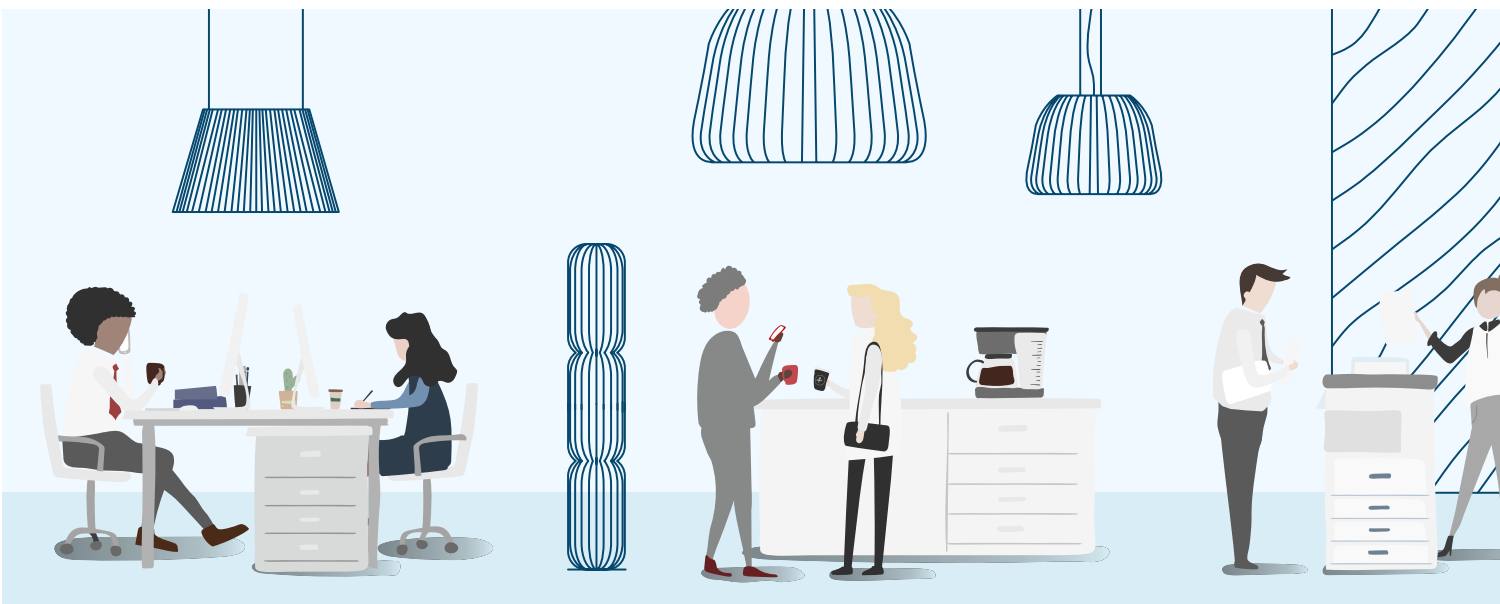

EN The office of the future sounds like a party! But even if you like music, silence works best. When sound waves hit hard surfaces in a room, like walls, floors, and windows, the audible wave of energy we call noise bounces off them, which increases the overall noise level.

DE Das Büro der Zukunft klingt wie eine Party! Aber auch wenn Sie Musik mögen, Stille funktioniert am besten. Wenn Schallwellen in einem Raum auf harte Oberflächen wie Wände, Böden und Fenster treffen, prallt die hörbare Energiewelle, die wir Lärm nennen, von ihnen ab, was den Gesamtschallpegel erhöht.

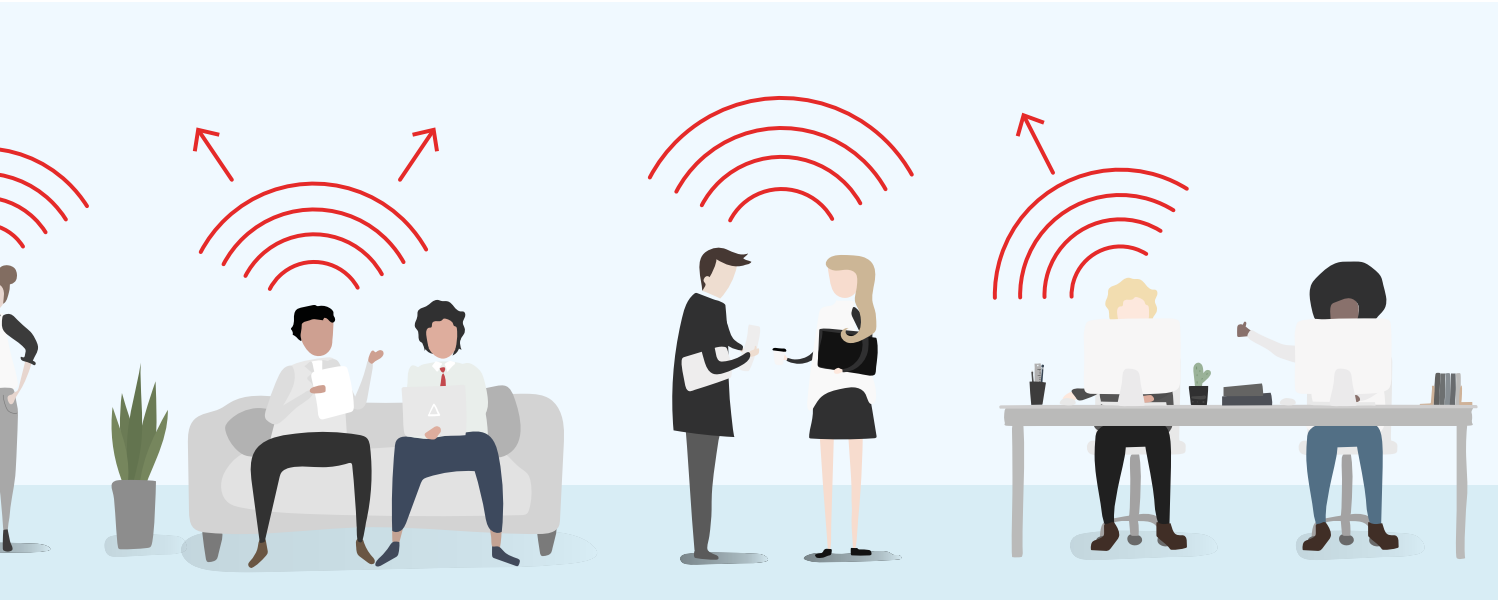

EN Flexxica's acoustic office solutions mean more productive and satisfied employees, as well as increased revenue and reduced staff turnover. New well-designed acoustical workplaces are becoming centers of teamwork and personal engagement that have the power to serve the health and well-being of their users.

DE Flexxicas Akustik-Bürolösungen bedeuten produktivere und zufriedener Mitarbeiter sowie mehr Umsatz und geringere Mitarbeiterfluktuation. Neue gut gestaltete akustische Arbeitsplätze werden zu Zentren der Teamarbeit und des persönlichen Engagements, die der Gesundheit und dem Wohlbefinden ihrer Nutzer dienen können.



Flexxibility is our priority

The ability to see and be seen has never been more important.

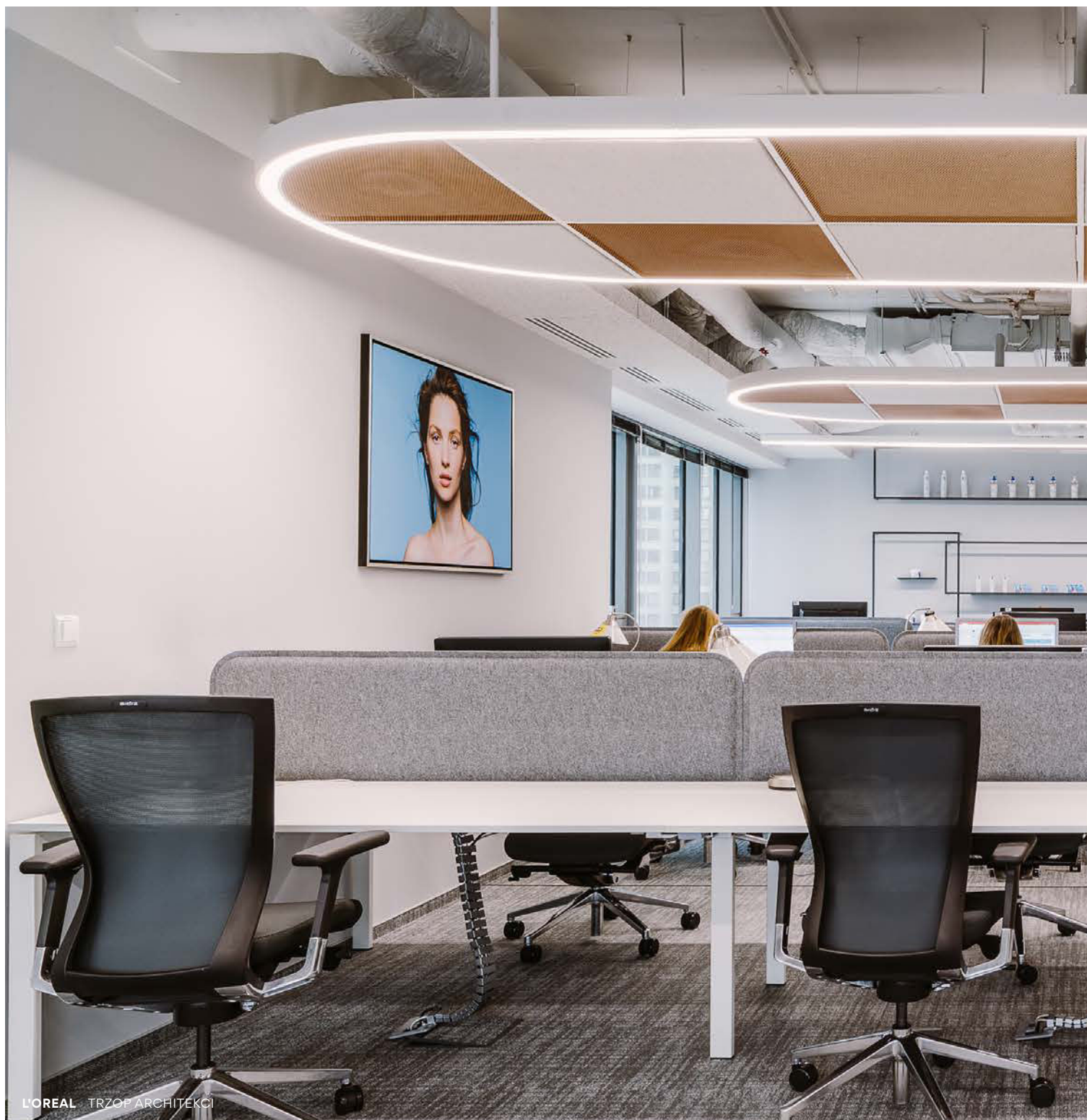

L'OREAL TRZOP ARCHITEKCI

EN Offices are now being designed more thoughtfully, with high-performing spaces that support specific activities, a range of people's preferences, and create diverse landscapes for the most effective work. This type of office tells employees that their company recognizes that providing people with the freedom to choose when, where, and how they work is necessary for their success. In these spaces, lighting is one of the most important features because the ability to see and be seen has never been more important.

DE Büros werden jetzt durchdachter gestaltet, mit leistungsstarken Räumen, die spezifische Aktivitäten, eine Reihe von Vorlieben der Menschen unterstützen und verschiedene Landschaften für die effektivste Arbeit schaffen. Diese Art von Büro sagt den Mitarbeitern, dass ihr Unternehmen erkennt, dass es für ihren Erfolg notwendig ist, Menschen die Freiheit zu geben, zu entscheiden, wann, wo und wie sie arbeiten. In diesen Räumen ist die Beleuchtung eines der wichtigsten Merkmale, denn die Fähigkeit zu sehen und gesehen zu werden war noch nie so wichtig.



Flexxica think bigger

EN We create lighting solutions that make the office a flexible space that adapts to users and drives ultimate productivity throughout the day. Flexxica agile lighting for future agile offices.

DE Wir schaffen Beleuchtungslösungen, die das Büro zu einem flexiblen Raum machen, der sich den Benutzern anpasst und den ganzen Tag über die ultimative Produktivität steigert. Flexxica agile Beleuchtung für zukünftige agile Büros.

Agile lighting
for future
agile offices.



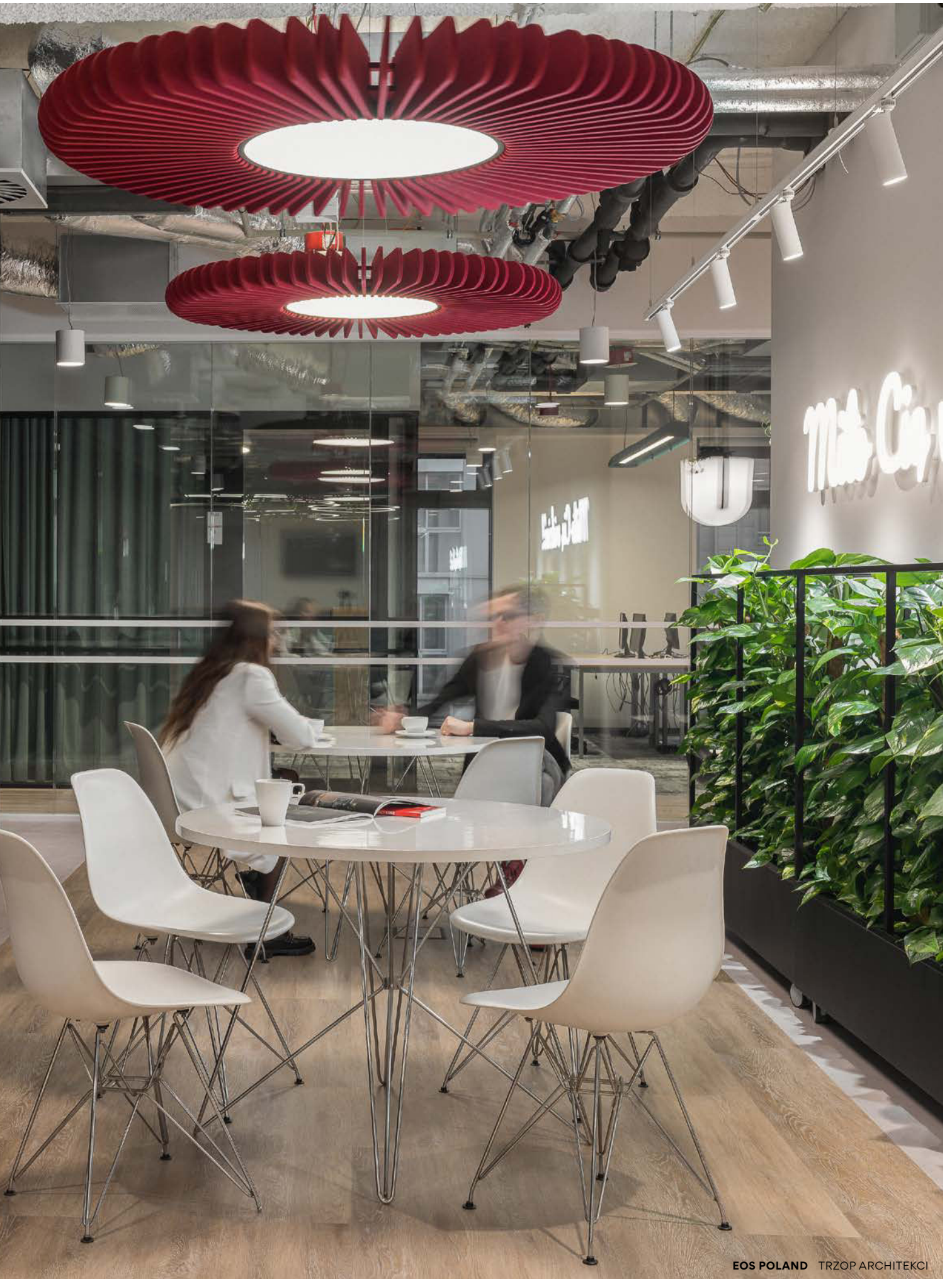

Biophilic harmony

EN We perform better and are happier when surrounded by nature. Because of this undeniable connection between people and nature, we are determined to cross impossible boundaries in our projects. We combine seemingly incompatible elements to form a single whole. Such is the case with plants. Placing them in our luminaires is what makes them something absolutely incredible. By creating a kind of an ecosystem amid the light, we contribute to the inner peace of those using our lighting. Furthermore, our office light fixtures designed in harmony with biophilia can reduce stress, enhance creativity and clarity of thought, and improve our well-being.

DE In jedem Kontakt mit der Natur erhalten wir weit mehr, als wir suchen. Wir schneiden besser ab und sind glücklicher, wenn wir von der Natur umgeben sind. Aufgrund dieser unbestreitbaren Verbindung zwischen Mensch und Natur sind wir entschlossen, in unseren Projekten unmögliche Grenzen zu überschreiten. Wir kombinieren scheinbar inkompatible Elemente zu einem Ganzen. Dies ist bei Pflanzen der Fall. Sie in unseren Leuchten zu platzieren, macht sie zu etwas absolut Unglaublichem. Indem wir eine Art Ökosystem inmitten des Lichts schaffen, tragen wir zum inneren Frieden derer bei, die unsere Beleuchtung nutzen. Darüber hinaus können unsere Büroleuchten, die im Einklang mit Biophilie entwickelt wurden, Stress reduzieren, Kreativität und Klarheit des Denkens sowie unser Wohlbefinden verbessern.





In every contact with nature, we receive far more than we seek.

Light control

EN In flexxica, we create a new generation of office lighting, which is energy-efficient and can be used with pioneering and innovating intelligence. Therefore, energy consumption and ongoing operating costs can be significantly reduced thanks to the dedicated protocol for digital lighting control, whose fundamental feature is that it enables accurate, repeatable, and standardized control of light-level outputs. In addition to reducing energy consumption, dimming also extends the service life of your lights and makes a valuable contribution to reducing light pollution. Flexxica brings this innovation to your office with its professional lighting products.

DE In flexxica schaffen wir eine neue Generation von Bürobeleuchtung, die energieeffizient ist und mit zukunftsweisender und innovativer Intelligenz eingesetzt werden kann. Daher können der Energieverbrauch und die laufenden Betriebskosten dank des dedizierten Protokolls für die digitale Beleuchtungssteuerung deutlich gesenkt werden, dessen grundlegendes Merkmal darin besteht, dass es eine genaue, wiederholbare und standardisierte Steuerung der Lichtleistung ermöglicht. Neben der Reduzierung des Energieverbrauchs verlängert das Dimmen auch die Lebensdauer Ihrer Leuchten und leistet einen wertvollen Beitrag zur Reduzierung der Lichtverschmutzung. Flexxica bringt diese Innovation mit seinen professionellen Beleuchtungsprodukten in Ihr Büro.



AUTODESK THE DESIGN GROUP



Light when needed
as much as needed.

Human-centric lighting

The positive impact of office lighting on wellbeing and productivity.

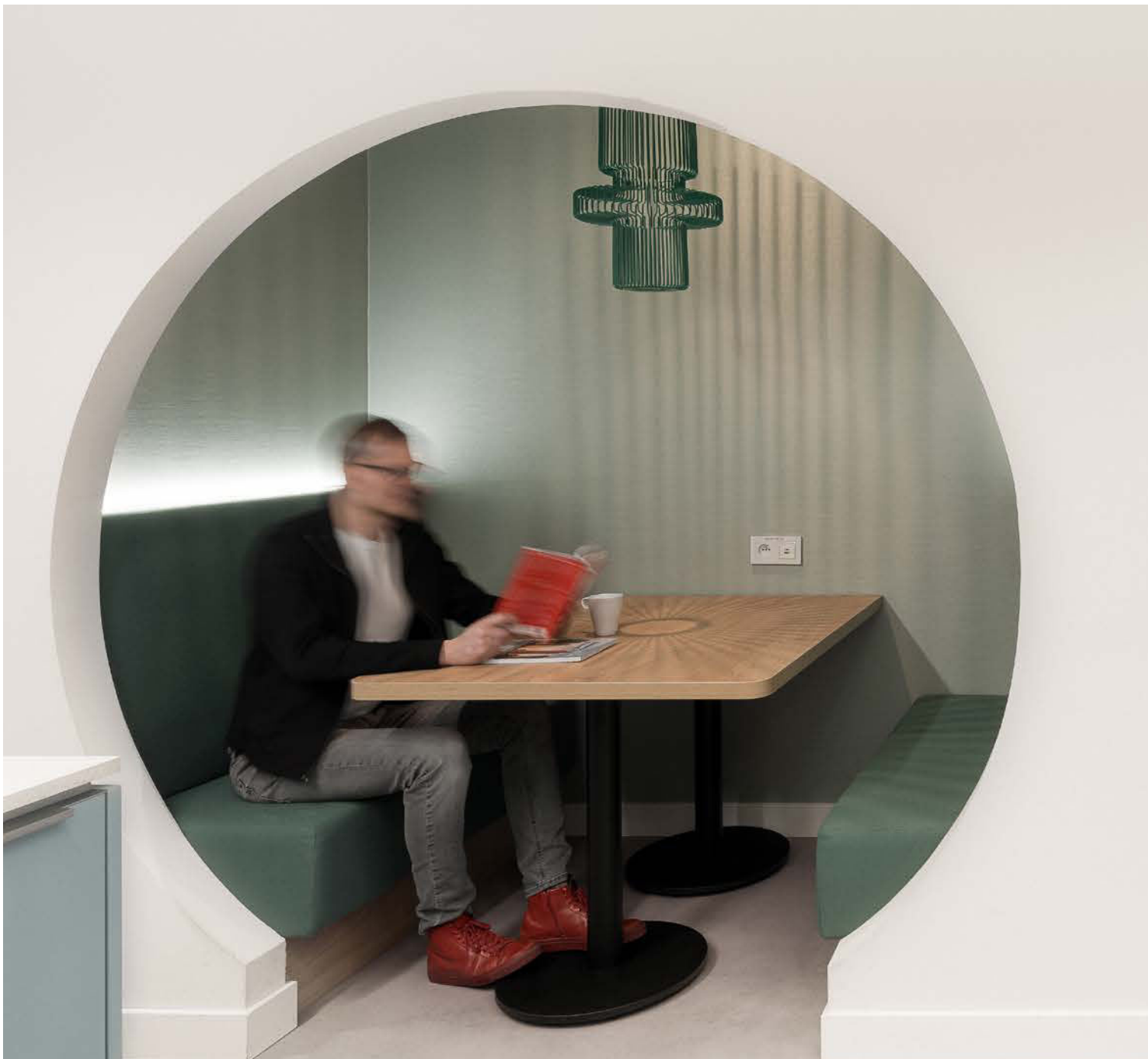

EN Flexxica attaches great importance to the positive impact of office lighting on wellbeing and productivity. Set to the correct brightness and color temperature, our lighting complements the daylight necessary for a healthy circadian rhythm. When simulated natural light is aligned with the internal biological clock in the workplace, it can improve concentration and energy, boost employee motivation and engagement and improve productivity, awareness and job satisfaction. While designing lighting in line with the concept of Human Centric Lighting, we make every effort to imitate sunlight effectively; so the light emitted from our luminaire does not shine point-wise but like the sun – not only directly on the illuminated surface but also by reflection from walls and surrounding objects.

DE Flexxica legt großen Wert auf den positiven Einfluss der Bürobeleuchtung auf Wohlbefinden und Produktivität. Auf die richtige Helligkeit und Farbtemperatur eingestellt, ergänzt unsere Beleuchtung das Tageslicht, das für einen gesunden zirkadianen Rhythmus erforderlich ist. Wenn simuliertes Tageslicht auf die innere biologische Uhr am Arbeitsplatz ausgerichtet wird, kann es die Konzentration und Energie verbessern, die Motivation und das Engagement der Mitarbeiter steigern und die Produktivität, das Bewusstsein und die Arbeitszufriedenheit verbessern. Während wir die Beleuchtung nach dem Konzept der Human Centric Lighting gestalten, bemühen wir uns, das Sonnenlicht effektiv zu imitieren. So strahlt das von unserer Leuchte emittierte Licht nicht punktuell, sondern wie die Sonne – nicht nur direkt auf der beleuchteten Fläche, sondern auch durch Reflexion von Wänden und umgebenden Objekten.



EOS POLAND TRZOP ARCHITEKCI

The transformative power of colors

EN In the realm of office design, colors wield a significant influence on the atmosphere, productivity, and overall experience of employees. The strategic use of colors can inspire creativity, enhance focus, and create a harmonious work environment.

Colors have the ability to ignite motivation and productivity in the workplace. Vibrant and energizing colors like yellow and orange can boost enthusiasm and stimulate creative thinking. These shades work well in common areas and collaborative spaces, encouraging interaction and generating a sense of excitement. On the other hand, muted tones like blue

and green promote a calm and focused atmosphere, ideal for individual workstations and areas requiring concentration.

By carefully selecting and integrating colors, designers can transform ordinary office environments into dynamic and engaging spaces that foster creativity, collaboration, and productivity. Recognizing the impact of colors on individuals' well-being and comfort is key to creating workspaces that inspire, support, and enhance the overall experience of employees.



DE Im Bereich der Bürogestaltung haben Farben einen erheblichen Einfluss auf die Atmosphäre, die Produktivität und das Gesamterlebnis der Mitarbeiter. Der strategische Einsatz von Farben kann die Kreativität anregen, die Konzentration verbessern und ein harmonisches Arbeitsumfeld schaffen.

Farben haben die Fähigkeit, die Motivation und Produktivität am Arbeitsplatz zu steigern. Lebendige und anregende Farben wie Gelb und Orange können den Enthusiasmus steigern und das kreative Denken anregen. Diese Farbtöne eignen sich gut für Gemeinschaftsbereiche und Räume für die Zusammenarbeit, da sie die Interaktion fördern und ein Gefühl der Aufregung erzeugen. Dagegen fördern

gedämpfte Töne wie Blau und Grün eine ruhige und konzentrierte Atmosphäre, ideal für Einzelarbeitsplätze und Bereiche, die Konzentration erfordern.

Durch die sorgfältige Auswahl und Integration von Farben können Designer gewöhnliche Büroumgebungen in dynamische und ansprechende Räume verwandeln, die die Kreativität, Zusammenarbeit und Produktivität fördern. Das Erkennen des Einflusses von Farben auf das Wohlbefinden und den Komfort des Einzelnen ist der Schlüssel zur Schaffung von Arbeitsbereichen, die inspirieren, unterstützen und die Gesamterfahrung der Mitarbeiter verbessern.





ING KATOWICE MAŁECCY BIURO PROJEKTOWE



Acoustic ecoPET

EN Acoustic ecoPET is a family of oversize light fittings dedicated to modern office spaces which merges the functionality of a light fixture with the properties of an acoustic panel. The family consists of three types of lamps: pendant, wall and floor. Due to their size and material, each Acoustic ecoPET lamp has super sound-absorbing qualities. Despite their strong visuals, they create a cozy atmosphere.

Flexxica Acoustic ecoPET lamp family has been honored in the Design Plus powered by Light + Building award! flexxica was also awarded »Gold« in the category of Lighting in the area of Excellent Product Design for the luminaire series »Flexxica Acoustic ecoPET Bell« at the German Design Awards 2023.



DE Acoustic ecoPET ist eine Familie von übergroßen Leuchten für moderne Büroräume, die die Funktionalität einer Leuchte mit den Eigenschaften einer Akustikplatte verbindet. Die Familie besteht aus drei Arten von Leuchten: Pendel-, Wand- und Bodenleuchten. Aufgrund ihrer Größe und ihres Materials verfügt jede Acoustic ecoPET-Leuchte über hervorragende schallabsorbierende Eigenschaften. Trotz ihrer starken Optik schaffen sie eine gemütliche Atmosphäre.

Die Flexxica Acoustic ecoPET Leuchtenfamilie wurde mit dem Design Plus powered by Light + Building ausgezeichnet! Beim German Design Award 2023 wurde flexxica für die Leuchtenserie "Flexxica Acoustic ecoPET Bell" in der Kategorie Lighting im Bereich Excellent Product Design mit "Gold" ausgezeichnet.

Zen Collection





269
PET
BOTTLESup to
10.14 m²
ACOUSTIC
SURFACE

Zen



EN Zen acoustic luminaire is a family of four ribbed shape office lamps made of sound-absorbing material designed to provide both functional lighting and acoustic benefits in an office or workspace setting. The lampshade features a series of parallel ridges, which not only give it a distinctive and modern look but also serve to diffuse the light and reduce glare. The lampshade is made from a sound-absorbing material composed of recycled PET bottles. This material helps to reduce ambient noise in the office by absorbing sound waves and preventing them from bouncing off hard surfaces.

Acoustic Zen, the ribbed shape office lamp made of sound-absorbing material, is a stylish and eco-friendly lighting solution that can help to create a more comfortable and productive workspace.

DE Die Zen-Akustikleuchte ist eine Familie von vier gerippten Bürolampen aus schallabsorbierendem Material, die sowohl funktionale Beleuchtung als auch akustische Vorteile in einem Büro- oder Arbeitsbereich bieten. Der Lampenschirm weist eine Reihe paralleler Rippen auf, die ihm nicht nur ein unverwechselbares und modernes Aussehen verleihen, sondern auch dazu dienen, das Licht zu streuen und Blendung zu reduzieren. Der Lampenschirm besteht aus einem schallabsorbierenden Material aus recycelten PET-Flaschen. Dieses Material trägt dazu bei, Umgebungsgeräusche im Büro zu reduzieren, indem es Schallwellen absorbiert und verhindert, dass sie von harten Oberflächen abprallen.

Acoustic Zen, die gerippte Bürolampe aus schallabsorbierendem Material, ist eine stilvolle und umweltfreundliche Beleuchtungslösung, die dazu beitragen kann, einen komfortableren und produktiveren Arbeitsplatz zu schaffen.

Example

Zen
↑
2150 - 01 - 2 - 8 - 3 - 01 - 00 - 2 - archi1201

standard power
↑
3000K
no frame
↑
ARCHI felt color 1201 Cloud
↑

↓
size S
↓
DALI
↓
luminaire black 9005
↓
pendant

Quickinfo

	Zen S ■ 01	Zen M ■ 02	Zen LA ■ 03	Zen LB ■ 04
luminaire size	Ø550×550	Ø760×400	Ø960×620	Ø960×620
light source size	Ø140×162	Ø140×162	Ø320×57	Ø600×82
system power	↓15W ST ~ 2 ↓23W HI ~ 3	↓15W ST ~ 2 ↓23W HI ~ 3	↓10W LO ~ 1 ↓15W ST ~ 2 ↓20W HI ~ 3	48W ~ 2 ↓34W ↑14W
luminous flux	↓1077lm ↓1508lm	↓1077lm ↓1508lm	↓1200lm ↓1800lm ↓2400lm	↓3500lm ↑1750lm
UGR	<19	<19		<17
light distribution - up				100°
light distribution - down	40°	40°	150°	95°
luminous efficiency	74lm/W	74lm/W	120lm/W	116lm/W

Technical information



electrical control	ON/OFF	▲ 9
	DALI	▲ 8
color temperature	3000K	● 3
	4000K	● 4
luminaire color	black (01/02/04)	◆ 01
	white	◆ 02
fabric color	ARCHI felt ecoPET color palette archixxx - choose color from page 266	◆ archixxx

Create my unique code!

2150 - ■ - ~ - ▲ - ● - ◆ - 00 - 2 - ◆

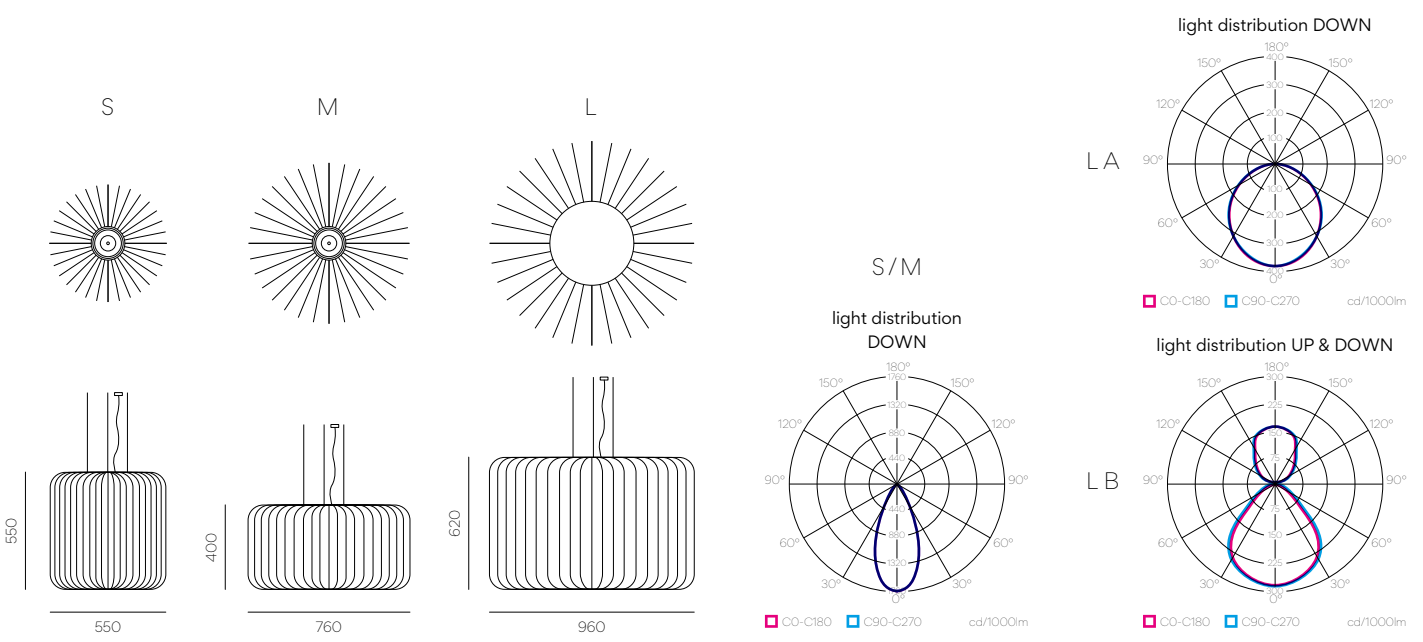

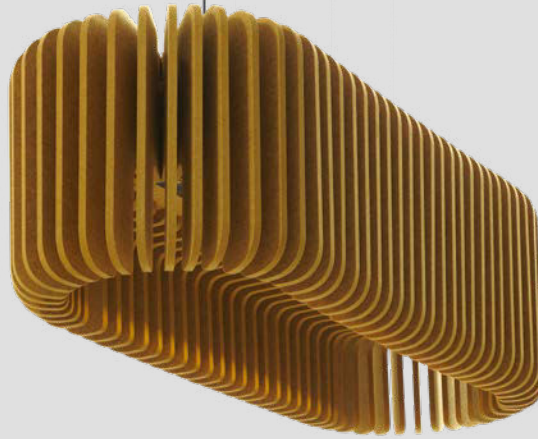
277
PET
BOTTLESup to
10.46 m²
ACOUSTIC
SURFACE

Zen Oval



EN Zen acoustic luminaire is a family of four ribbed shape office lamps made of sound-absorbing material designed to provide both functional lighting and acoustic benefits in an office or workspace setting. The lampshade features a series of parallel ridges, which not only give it a distinctive and modern look but also serve to diffuse the light and reduce glare. The lampshade is made from a sound-absorbing material composed of recycled PET bottles. This material helps to reduce ambient noise in the office by absorbing sound waves and preventing them from bouncing off hard surfaces.

Acoustic Zen, the ribbed shape office lamp made of sound-absorbing material, is a stylish and eco-friendly lighting solution that can help to create a more comfortable and productive workspace.

DE Die Zen-Akustikleuchte ist eine Familie von vier gerippten Bürolampen aus schallabsorbierendem Material, die sowohl funktionale Beleuchtung als auch akustische Vorteile in einem Büro- oder Arbeitsbereich bieten. Der Lampenschirm weist eine Reihe paralleler Rippen auf, die ihm nicht nur ein unverwechselbares und modernes Aussehen verleihen, sondern auch dazu dienen, das Licht zu streuen und Blendung zu reduzieren. Der Lampenschirm besteht aus einem schallabsorbierenden Material aus recycelten PET-Flaschen. Dieses Material trägt dazu bei, Umgebungsgeräusche im Büro zu reduzieren, indem es Schallwellen absorbiert und verhindert, dass sie von harten Oberflächen abprallen.

Acoustic Zen, die gerippte Bürolampe aus schallabsorbierendem Material, ist eine stilvolle und umweltfreundliche Beleuchtungslösung, die dazu beitragen kann, einen komfortableren und produktiveren Arbeitsplatz zu schaffen.

Example

Zen Oval	standard power	3000K	no frame	ARCHI felt color 1201 Cloud
↑	↑	↑	↑	↑
2151 - 00	- 2	- 8	- 3	- 01
	- 00	- 2	- archi1201	
↓	↓	↓	↓	
one size	DALI	luminaire black 9005	pendant	

Quickinfo

luminaire size	1350×550×420
light source size	856×43
system power	↓14.7W
luminous flux	↓1734lm
UGR	<19
light distribution – down	80°
luminous efficiency	117lm/W

Technical information



electrical control	ON / OFF	▲ 9
	DALI	▲ 8
color temperature	3000K	● 3
	4000K	● 4
	on request: TUNABLE WHITE	● 9
luminaire color	black	◆ 01
	white	◆ 02
fabric color	ARCHI felt ecoPET color palette archixxx – choose color from page 266	◆ archixxx

Create my unique code!

2151 - 00 - 2 - ▲ - ● - ◆ - 00 - 2 - ◆

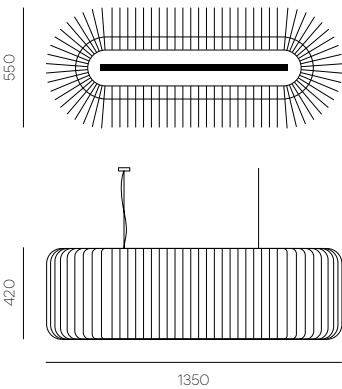

On request we can produce it in other sizes!

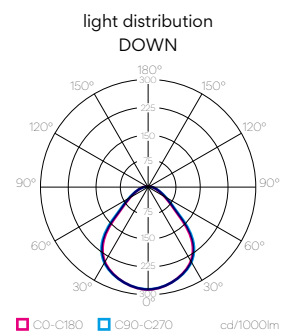

Bell Collection





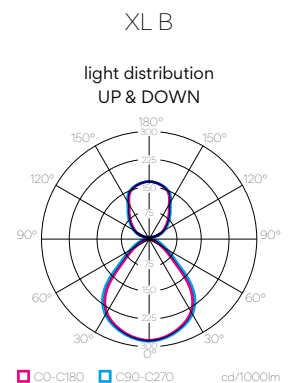
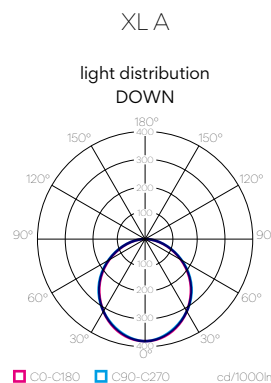
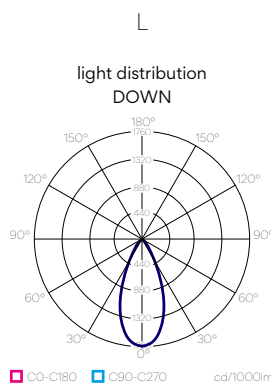
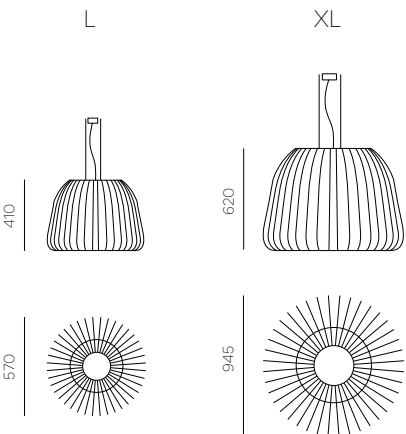

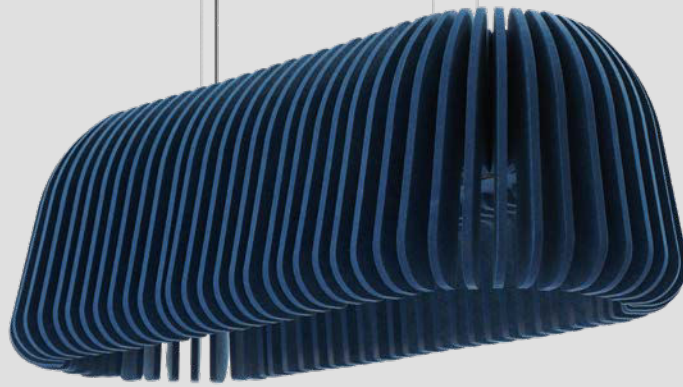
217
PET
BOTTLESup to
8.20m²ACOUSTIC
SURFACE

Bell Oval

EN The Bell Oval represents the largest member of the Bell Collection. Its substantial dimensions bring substantial sound-absorbing properties to any space. Tailored to brighten multiple workstations in offices, it also graces hotel lobbies and restaurants with its extensive coverage. The fixture is equipped with a linear light source and an efficient optical system, ensuring an even and glare-free distribution of light. With interchangeable reflectors in black, white, silver, and gold, this luminaire provides boundless design possibilities. Crafted with meticulous attention to detail, this lamp effortlessly marries top-tier quality with extraordinary lighting capabilities.

DE Die Bell Oval ist das größte Mitglied der Bell Collection. Seine beträchtlichen Abmessungen verleihen jedem Raum erhebliche schallabsorbierende Eigenschaften. Die Leuchte ist für die Beleuchtung von mehreren Arbeitsplätzen in Büros geeignet, kann aber auch in Hotellobbys und Restaurants eingesetzt werden, wo sie eine große Reichweite hat.

Die Leuchte ist mit einer linearen Lichtquelle und einem effizienten optischen System ausgestattet, das eine gleichmäßige und blendfreie Lichtverteilung gewährleistet. Mit austauschbaren Reflektoren in Schwarz, Weiß, Silber und Gold bietet diese Leuchte grenzenlose Gestaltungsmöglichkeiten. Diese mit viel Liebe zum Detail gefertigte Leuchte verbindet mühelos Spitzenqualität mit außergewöhnlichen Beleuchtungsmöglichkeiten.

Example

Bell Oval	standard power	3000K	no frame	ARCHI felt color 1201 Cloud
↑	↑	↑	↑	↑
2155 - 00	- 2	- 8	- 3	- 01
	- 00	- 2	- archi1201	
↓	↓	↓	↓	
one size	DALI	luminaire black	pendant	

Quickinfo

luminaire size	1350×550×416
light source size	856×43
system power	↓14.7W
luminous flux	↓1734lm
UGR	<19
light distribution - down	80°
luminous efficiency	117lm/W

Technical information

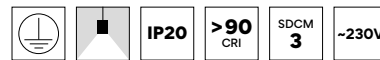

electrical control	ON / OFF	▲ 9
	DALI	▲ 8
color temperature	3000K	● 3
	4000K	● 4
	on request: TUNABLE WHITE	● 9
luminaire color	black	◆ 01
	white	◆ 02
fabric color	ARCHI felt ecoPET color palette archixxx - choose color from page 266	◆ archixxx

Create my unique code!

2155 - 00 - 2 - ▲ - ● - ◆ - 00 - 2 - ◆

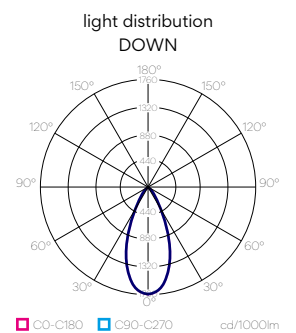
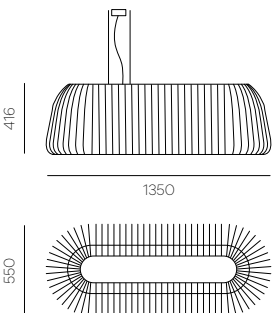

74
PET
BOTTLESup to
2.80m²
ACOUSTIC
SURFACE

Bell Wall



EN Bell wall lamp is characterized by timeless elegance while taking deep care of the natural environment – lamps are made from synthetic felt manufactured from recycled PET bottles. Following a contemporary design approach, the Bell wall lamp has achieved a sculptural appearance and impresses as an aesthetic and high-quality light source. When placed in an open space office, it reduces ambient noise and creates comfortable working conditions. Thanks to the large dimensions of the wall lamp, it offers a new 3D light effect that accentuates walls in a refined light to create a gentle backlight. As part of the Acoustic ecoPET Bell lighting series, this wall lamp was designed for installation in office spaces for indirect ambient lighting. The tongue and groove assembly parts are filigrees yet robust, while their simplicity conceals a technology complex structure.

DE Die Bell-Wandleuchte zeichnet sich durch zeitlose Eleganz aus, während sie gleichzeitig auf die natürliche Umwelt achtet – Lampen werden aus synthetischem Filz hergestellt, der aus recycelten PET-Flaschen hergestellt wird. Einem zeitgemäßen Designansatz folgend, hat die Leuchte Bell eine skulpturale Anmutung erreicht und beeindruckt als ästhetischer und hochwertiger Lichtspender. Wenn es in einem Großraumbüro aufgestellt wird, reduziert es Umgebungsgeräusche und schafft angenehme Arbeitsbedingungen. Dank der großen Abmessungen, bietet sie einen neuartigen 3D-Lichteffekt, der die Wände in einem raffinierten Licht akzentuiert und eine sanfte Hintergrundbeleuchtung erzeugt. Als Teil der Serie Acoustic ecoPET, Bell wurde die Bell für den Einbau in Büroräumen zur indirekten Grundbeleuchtung konzipiert. Die Klicksystem-Verbindungssteile sind filigran und dennoch robust, während ihre Einfachheit einen technologisch komplexen Aufbau verbirgt.

Example

Bell Wall	standard power	4000K	no frame	ARCHI felt color 1201 Cloud
↑	↑	↑	↑	↑
2118 - 00 - 2 - 8 - 4 - 01 - 00 - 7 - archi1201				
↓	↓	↓	↓	↓
one size	DALI	luminaire black 9005	wall	

Quickinfo

luminaire size	360×600×210
system power	3W
luminous flux	4488lm

Technical information

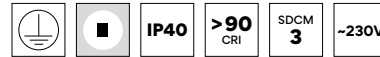

light distribution	360°
luminous efficiency	162lm/W
electrical control	ON / OFF ▲ 9 DALI ▲ 8
color temperature	3000K ● 3 4000K ● 4
luminaire color	black 9005 ◆ 01 white 9010 ◆ 02
fabric color	ARCHI felt ecoPET color palette archixx – choose color from page 266 ◆ archixx

Create my unique code!

2118 - 00 - 2 - ▲ - ● - ◆ - 00 - 7 - ◆

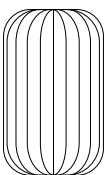

600



360

210

180
PET
BOTTLESup to
6.80m²ACOUSTIC
SURFACE

Bell Floor 2.0

EN Bell Floor 2.0 is a tall freestanding lamp equipped with a highly bright COB LED. This lamp is inspired by the horizontal separation between a room's illuminated and non-illuminated areas. The Bell Floor 2.0 lamp naturally uses the vertical light distribution to illuminate the ceiling and the upper wall surf. The lens mixes tunable white colors and floods the entire ceiling of the room in which it is placed. The body is made from an ecoPET panel with exceptional sound absorption properties, and the cylindrical lamp base, in particular, yields a high visual concision. Due to its reduced language of form, the floor lamp is reminiscent of a simple sculpture, crowned by a luminous aura. The consistent focus on clear lines and reduced lighting effects lend the Bell Floor 2.0 lamp a sculptural presence in the room.

DE Bell Floor 2.0 ist eine hohe, freistehende Leuchte, die mit einer sehr hellen COB-LED ausgestattet ist. Diese Leuchte ist inspiriert von der horizontalen Trennung zwischen beleuchteten und unbeleuchteten Bereichen eines Raums. Auf natürliche Weise nutzt die Stehleuchte Bell Floor 2.0 die vertikale Lichtverteilung zur Beleuchtung der Decke und der oberen Wandbrandung. Die Linse mischt abstimmbare weiße Farben und flutet die gesamte Decke des Raums in den sie steht. Der Körper besteht aus ecoPET mit hervorragenden Schallabsorptionseigenschaften, und insbesondere der zylindrische Lampenfuß ergibt eine hohe optische Prägnanz. Durch ihre reduzierte Formensprache erinnert die Stehleuchte an eine schlichte Skulptur, gekrönt von einer leuchtenden Aura. Die konsequente Ausrichtung auf klare Linien und reduzierte Lichteffekte verleihen der Stehleuchte Bell Floor 2.0 eine skulpturale Präsenz im Raum.

Example

Bell Floor 2.0	standard power	tunable white	no frame	ARCHI felt color 1201 Cloud
↑	↑	↑	↑	↑
2119 - 00	- 2	- 8	- 9	- 01
	- 00	- 8	- archi1201	
↓	↓	↓	↓	
one size	DALI	luminaire black 9005	floor	

Quickinfo

luminaire size	Ø 330 x 1874
light source size	Ø 90
system power	↑49W
luminous flux	↑4140lm
UGR	<19

Technical information

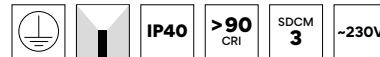

light distribution - up	91°
luminous efficiency	84lm/W
electrical control	CASAMBI ▲ 7 DALI ▲ 8
color temperature	TUNABLE WHITE
luminaire color	black 9005 ● 01 white 9010 ● 02
fabric color	ARCHI felt ecoPET color palette ◆ archixxx archixxx - choose color from page 266

Create my unique code!

2119 - 00 - 2 - ▲ - 9 - ● - 00 - 8 - ◆

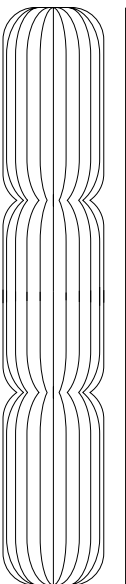

1874

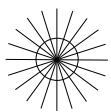

330

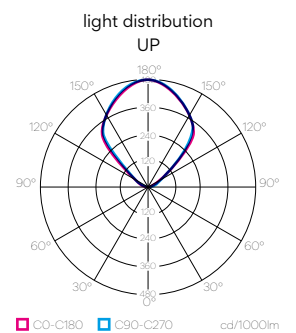

288
PET
BOTTLESup to
10.87 m²ACOUSTIC
SURFACE

Gamma Round

EN The design of the Gamma Round lamp emphasizes small individual ecoPET ribs that converge to create a circular structure, tapering at the top and widening towards the bottom, resulting in a broad light distribution angle. This design feature contributes to an improved acoustic comfort experience. Gamma Round provides effective lighting for open workspaces, utilizing adjustable brightness settings to meet the diverse needs of users. The lamp's circular shape enhances its ability to cast a uniform and encompassing light, creating an optimal environment for focus and collaboration. Integrated LED technology ensures energy efficiency, underscoring its dedication to reducing environmental impact.

DE Das Design der Gamma Round Leuchte betont die kleinen einzelnen ecoPET-Rippen, die zu einer kreisförmigen Struktur zusammenlaufen, die sich nach oben hin verjüngt und nach unten hin verbreitert, was zu einem breiten Lichtverteilungswinkel führt. Dieses Designmerkmal trägt zu einem verbesserten akustischen Komfort bei. Gamma Round bietet eine effektive Beleuchtung für offene Arbeitsbereiche, wobei die Helligkeit an die unterschiedlichen Bedürfnisse der Benutzer angepasst werden kann. Die runde Form der Leuchte verbessert ihre Fähigkeit, ein gleichmäßiges und umfassendes Licht abzugeben, und schafft so eine optimale Umgebung für konzentriertes Arbeiten und Zusammenarbeit. Die integrierte LED-Technologie sorgt für Energieeffizienz und unterstreicht das Engagement für eine geringere Umweltbelastung.

Example

Gamma Round	standard power	3000K	no frame	ARCHI felt color 1201 Cloud
↑	↑	↑	↑	↑
2162 - 01 - 2 - 8 - 3 - 02 - 00 - 2 - archi1201				
↓	↓	↓	↓	
size L	DALI	luminaire white	pendant	

Quickinfo

	Gamma Round L ■ 01	Gamma Round XL ■ 02
luminaire size	Ø 880×620	Ø 1150×750
light source size	A Ø 320×57	Ø 320×57
	B Ø 450×82	Ø 450×82
system power	A ↓10W LO ~ 1 ↓15W ST ~ 2 ↓20W HI ~ 3	
	B 30W (↑9W ↓21W)	
luminous flux	A ↓1200lm ↓1800lm ↓2400lm	
	B ↑1000lm ↓2100lm	
UGR	B <19	<19

Technical information

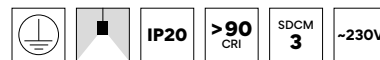

light distribution - down	A 150°	
	B 95°	
light distribution - up	B 100°	
luminous efficiency	A 120lm/W	
	B 110lm/W	
electrical control	ON / OFF	▲ 9
	DALI	▲ 8
color temperature	A 3000K	● 3
	4000K	● 4
	6000K	● 6
	B 3000K	● 3
	4000K	● 4
luminaire color	B black	■ 01
	A B white	■ 02
fabric color	ARCHI felt ecoPET color palette archixx - choose color from page 50	■ archixx

Create my unique code!

2162 - ■ - ~ - ▲ - ● - 02 - 00 - 2 - ◆



L

XL

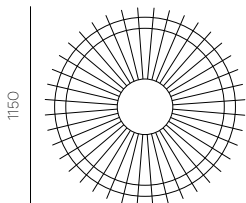
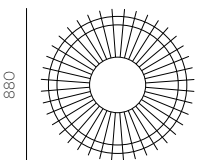
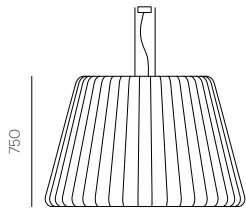
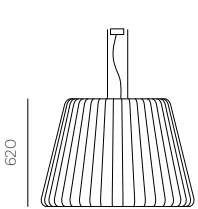

A

B

light distribution
UP & DOWN

light distribution
UP & DOWN

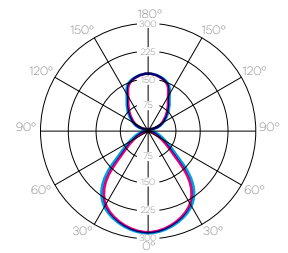
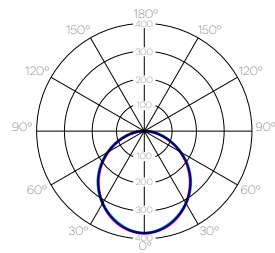

cd/1000lm

cd/1000lm

366
PET
BOTTLESup to
13.79 m²ACOUSTIC
SURFACE

Gamma Square

EN Gamma Square follows a similar design philosophy to Gamma Round. The lamp's emphasis is on small individual ecoPET ribs that converge to form a square structure, featuring tapered sides and a widening base, resulting in a generous light distribution angle. This design element enhances acoustic comfort. Gamma Square is designed to provide effective lighting in open workspaces, offering adjustable brightness settings to cater to diverse user needs. The square shape of the lamp ensures uniform and comprehensive light coverage, fostering an optimal environment for focus and collaboration. With integrated LED technology, Gamma Square maintains energy efficiency, demonstrating a commitment to reducing environmental impact.

DE Gamma Square folgt einer ähnlichen Designphilosophie wie Gamma Round. Der Schwerpunkt der Leuchte liegt auf den kleinen einzelnen ecoPET-Rippen, die zu einer quadratischen Struktur zusammenlaufen, mit sich verjüngenden Seiten und einer sich verbreiternden Basis, was zu einem großzügigen Lichtverteilungswinkel führt. Dieses Designelement erhöht den akustischen Komfort. Gamma Square wurde entwickelt, um eine effektive Beleuchtung in offenen Arbeitsbereichen zu gewährleisten und bietet einstellbare Helligkeitseinstellungen, um den unterschiedlichen Bedürfnissen der Benutzer gerecht zu werden. Die quadratische Form der Leuchte sorgt für eine gleichmäßige und umfassende Lichtabdeckung und fördert so eine optimale Umgebung für Konzentration und Zusammenarbeit. Dank der integrierten LED-Technologie ist die Gamma Square sehr energieeffizient und trägt damit zur Reduzierung der Umweltbelastung bei.

Example

Gamma Square	standard power	3000K	no frame	ARCHI felt color 1201 Cloud
↑	↑	↑	↑	↑
2163 - 01 - 2 - 8 - 3 - 02 - 00 - 2 - archi1201				
↓	↓	↓	↓	
size L	DALI	luminaire white	pendant	

Quickinfo

	Gamma Square L ■ 01	Gamma Square XL ■ 02
luminaire size	990 × 990 × 620	1150 × 1150 × 880
light source size	320 × 320 × 57	320 × 320 × 57
system power	↓10W LO ~ 1 ↓15W ST ~ 2 ↓20W HI ~ 3	
luminous flux	↓1200lm ↓1800lm ↓2400lm	

Technical information

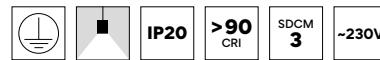

light distribution - down	150°
luminous efficiency	120lm/W
electrical control	ON/OFF ▲ 9 DALI ▲ 8
color temperature	3000K ● 3 4000K ● 4 6000K ● 6
luminaire color	white ◆ 02
fabric color	ARCHI felt ecoPET color palette archixxx - choose color from page 266 ◆ archixxx

Create my unique code!

2163 - ■ - ~ - ▲ - ● - 02 - 00 - 2 - ◆



L

XL

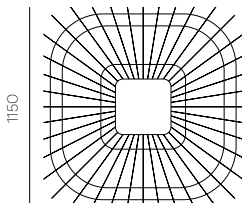
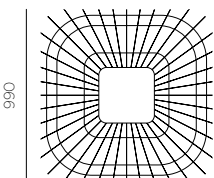
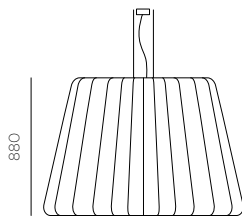
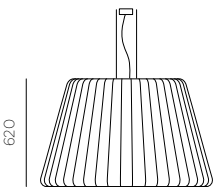

light distribution
UP & DOWN

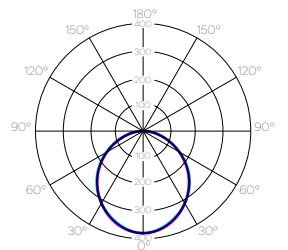

■ CO-C180 ■ C90-C270 cd/1000lm

Sol Collection

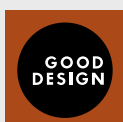





SHOWROOM MUNICH KUSCH+CO NOWY STYL

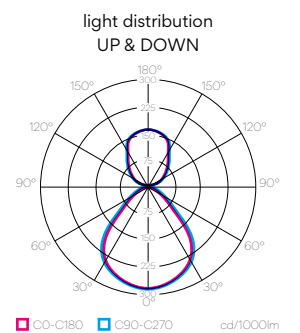
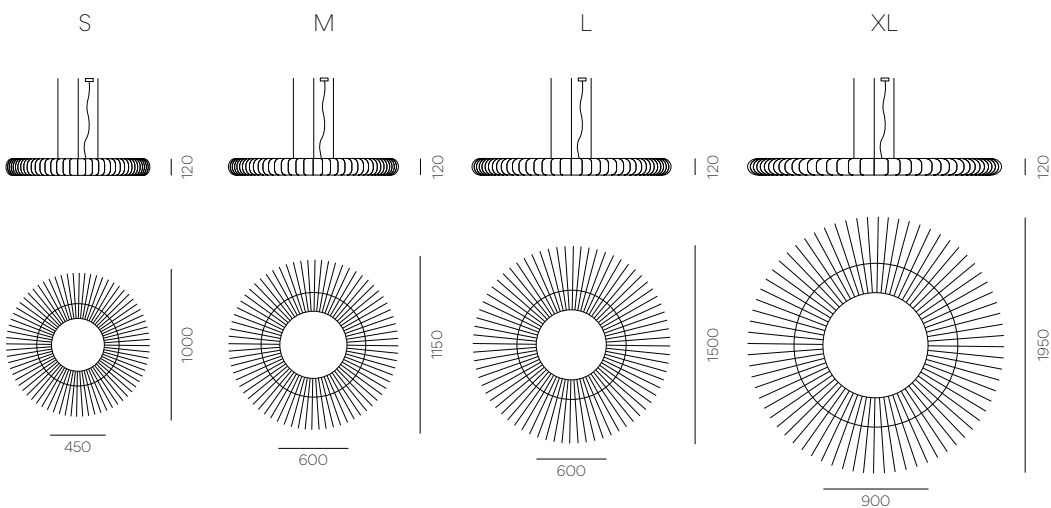

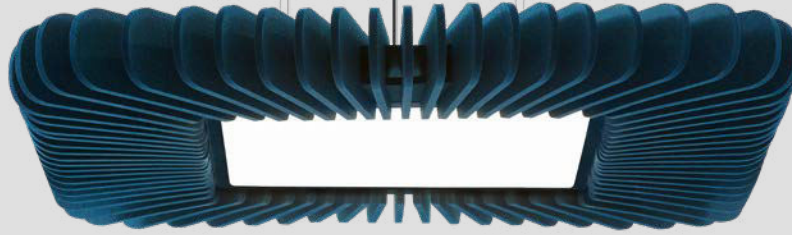
224
PET
BOTTLESup to
8.46 m²ACOUSTIC
SURFACE

Sol Square



EN Sol Square is crafted to radiate high-quality diffused light, it ensures an optimal environment for productivity. The micro prismatic diffuser further augments the dispersion of light, resulting in impeccable working conditions. Designed for offices prioritizing acoustics improvements Sol Square features many ecoPET wings around the lamp, reassembling rays of sun. This acts as sound absorbers, further reducing office noise, promoting overall acoustic comfort. It is crafted from material made from recycled PET bottles. It is nonflammable, durable and soft in touch. Available in a range of colors and finishes, these acoustic lamps effortlessly blend into modern eclectic office interiors.

DE Sol Square ist so konzipiert, dass sie hochwertiges, diffuses Licht ausstrahlt und eine optimale Umgebung für die Produktivität gewährleistet. Der mikroprismatische Diffusor verbessert die Lichtstreuung noch weiter, was zu tadellosen Arbeitsbedingungen führt. Sol Square wurde für Büros entwickelt, in denen die Verbesserung der Akustik im Vordergrund steht, und verfügt über zahlreiche Öko-PET-Flügel um die Lampe herum, die die Sonnenstrahlen wieder zusammensetzen. Diese fungieren als Schallabsorber, die den Lärm im Büro weiter reduzieren und den akustischen Komfort insgesamt fördern. Die Leuchte wird aus Material hergestellt, das aus recycelten PET-Flaschen gewonnen wird. Es ist nicht brennbar, langlebig und fühlt sich weich an. Diese Akustiklampen sind in verschiedenen Farben und Ausführungen erhältlich und fügen sich mühelos in moderne, eklektische Büroeinrichtungen ein.

Example

Sol Square	standard power	4000K	no frame	ARCHI felt color 1201 Cloud
↑	↑	↑	↑	↑
2147	- 01	- 2	- 8	- 4
		- 02	- 00	- 2
				- archi1201
	↓	↓	↓	↓
	size M	DALI	luminaire white	pendant

Quickinfo

	Sol Square M ■ 01	Sol Square L ■ 02
luminaire size	1150×1150×120	1500×1500×120
light source size	600×600×31	600×600×31
system power	↓40W	↓40W
luminous flux	↓4512lm	↓4512lm
UGR	<19	<19

Technical information



light distribution - down	90°
luminous efficiency	114lm/W
electrical control	ON / OFF ▲ 9 DALI ▲ 8
color temperature	3000K ● 3 4000K ● 4
luminaire color	white ◆ 02
fabric color	ARCHI felt ecoPET color palette archixxx - choose color from page 266 ◆ archixxx

Create my unique code!

2147 - ■ - 2 - ▲ - ● - 02 - 00 - 2 - ◆



M

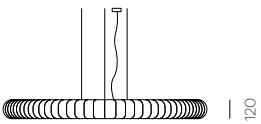

L

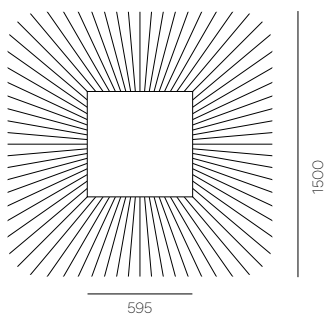
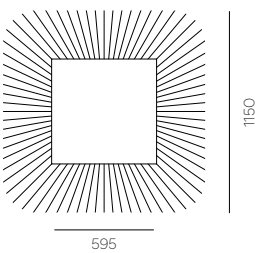
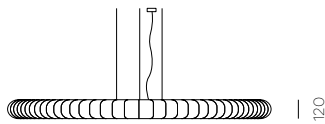

light distribution
DOWN

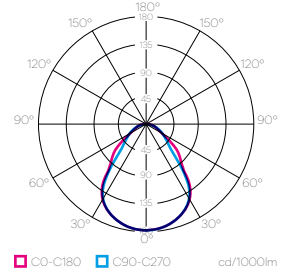

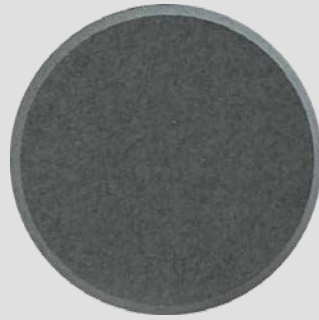
94
PET
BOTTLESup to
3.56m²ACOUSTIC
SURFACE

Sol Wall

EN Starting from a basic design concept of the Sol wall lamp, we focused on creating the connection between the simple geometry of a circle and the visual representation of the sun's rays. As a result, the Sol wall lamp is equipped with a circular disc made from the highest class of sound absorption ecoPET panels and a high-quality micro prismatic diffuser light source. The visually attractive aesthetics of this wall lamp make it stand out, while its clean lines make sure it blends harmoniously into any interior. This luminaire yields a particularly intensive spatial effect when combined in a group. The Sol wall lamp elegantly combines ambient lighting, which provides a soft, soothing, and uniform glow with the directional functionality of an LED indirect ambient light.

DE Ausgehend von einem grundlegenden Designkonzept der Sol Wandleuchte, haben wir uns darauf konzentriert die Verbindung zwischen der einfachen Geometrie eines Kreises und der visuellen Darstellung der Sonnenstrahlen herzustellen. Daher ist die Sol-Wandleuchte mit einer kreisförmigen Scheibe aus schallabsorbierenden ecoPET der höchsten Klasse und einer hochwertigen mikrop Prismatischen Diffusor-Lichtquelle ausgestattet. Die optisch ansprechende Ästhetik dieser Wandleuchte hebt sie hervor, während sie sich mit ihren klaren Linien harmonisch in jedes Interieur einfügt. In der Gruppe kombiniert entfaltet diese Leuchte eine besonders intensive Raumwirkung. Die Sol Wandleuchte kombiniert auf elegante Weise Umgebungsbeleuchtung, die für ein weiches, beruhigendes und gleichmäßiges Leuchten sorgt, mit der Richtungsfunktionalität eines indirekten LED-Umgebungslichts.

Example

Sol Wall	standard power	4000K	no frame	ARCHI felt color 1201 Cloud
↑	↑	↑	↑	↑
2121 - 00	- 2	- 8	- 4	- 01
- 00	- 00	- 00	- 7	- archi1201
↓	↓	↓	↓	
one size	DALI	luminaire black 9005	wall	

Quickinfo

luminaire size	Ø 400×100
system power	6W
luminous flux	624lm
UGR	<19

Technical information

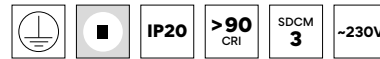

light distribution	360°
luminous efficiency	104lm/W
electrical control	ON / OFF ▲ 9
	DALI ▲ 8
color temperature	3000K ● 3
	4000K ● 4
luminaire color	black 9005 ◆ 01
	white 9010 ◆ 02
fabric color	ARCHI felt ecoPET color palette ◆ archixxx
	archixxx – choose color from page 266

Create my unique code!

2121 - 00 - 2 - ▲ - ● - ◆ - 00 - 7 - ◆

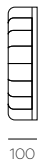
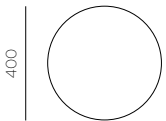

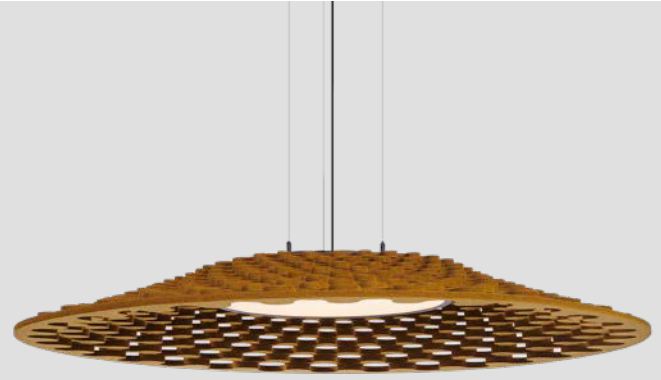
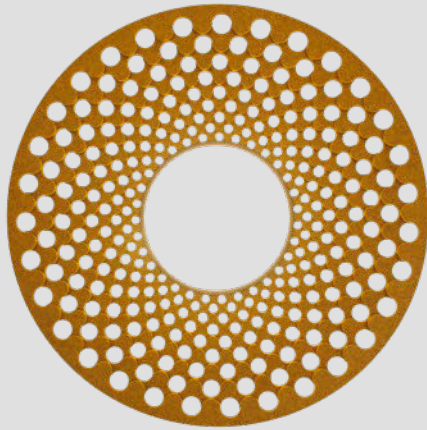
58
PET
BOTTLESup to
2.20 m²
ACOUSTIC
SURFACE

Sikt

EN Sikt is named after a Swedish word that is a play on the meaning of visibility and structure. The large size and detailed surface give this lamp excellent acoustic performance. When placed in a busy environment, it reduces ambient noise and creates comfortable working conditions. Perfect for conference rooms. It is made from ecoPET – synthetic felt panels manufactured from recycled PET bottles. It is delicate and soft to touch. ecoPET is non-flammable, very durable, and easy to maintain. It is created from recycled material and is possible to be recycled again. The product features a maintenance-free and energy-efficient light fitting. It is shipped fully assembled. The packaging features no plastic and is fully recyclable.

DE Sikt ist nach einem schwedischen Wort benannt, das mit der Bedeutung von Sichtbarkeit und Struktur spielt. Die Größe und die detaillierte Oberfläche verleihen dieser Lampe eine hervorragende akustische Leistung. Wenn es in einer geschäftigen Umgebung aufgestellt wird, reduziert es Umgebungsgeräusche und schafft angenehme Arbeitsbedingungen. Perfekt für Konferenzräume. Es besteht aus ecoPET – synthetischen Filz, das aus recycelten PET-Flaschen hergestellt wird. Es ist zart und fühlt sich weich an. ecoPET ist nicht brennbar, sehr langlebig und pflegeleicht. Es wird aus recyceltem Material hergestellt und kann wieder recycelt werden. Das Produkt zeichnet sich durch eine wartungsfreie und energieeffiziente Leuchte aus. Es wird fertig montiert versendet. Die Verpackung ist plastikfrei und vollständig recycelbar.

Example

Sikt	standard power	4000 K	no frame	ARCHI felt color 1201 Cloud
↑	↑	↑	↑	↑
2122 - 00	- 2 - 8	- 4 - 01	- 00 - 3	- archi1201
↓	↓	↓	↓	
one size	DALI	luminaire black	pendant up & down	

Quickinfo

luminaire size	Ø 1200 × 140
light source size	Ø 450 × 82
system power	30 W (±19 W ±21 W)
luminous flux	↑1000 lm ±2100 lm
UGR	< 18

Technical information

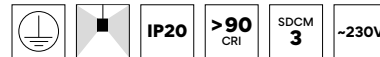

light distribution - up	100°
light distribution - down	95°
luminous efficiency	110 lm/W
electrical control	ON/OFF ▲ 9
	DALI ▲ 8
color temperature	3000 K ● 3
	4000 K ● 4
luminaire color	black ◆ 01
	white ◆ 02
fabric color	ARCHI felt ecoPET color palette archixxx – choose color from page 266 ◆ archixxx

Create my unique code!

2122 - 00 - 2 - ▲ - ● - ◆ - 00 - 3 - ◆

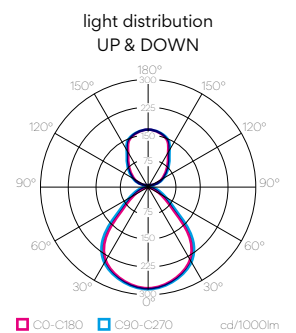
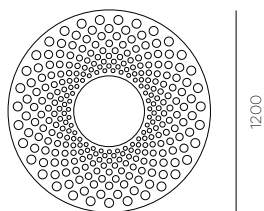
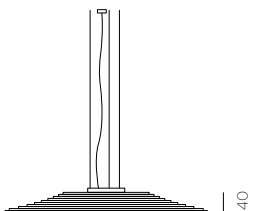

208
PET
BOTTLES

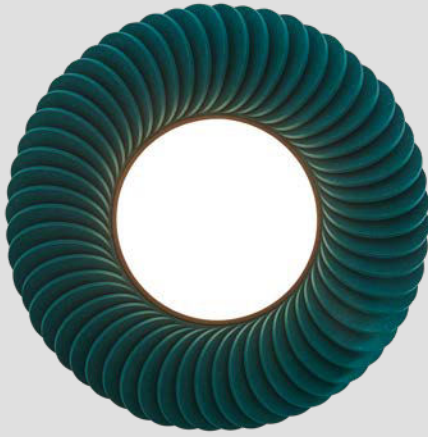

up to
7.84 m²
ACOUSTIC
SURFACE

Donut

EN This pendant office luminaire features a novel operation that shapes the healthy atmosphere of a workplace with its acoustic capabilities and homogeneous illumination of a high-quality LED light that minimises fatigue on the eyes. The glare-free pendant luminaire complies with demanding technical and ergonomic requirements, suitable for use in an open office space or conference room. Donut's body projects a formal simplicity and conveys a high sense of elegance. The glowing diffuser surface with a micro prismatic bottom complements the design. Following a sustainable design principle, Donut is made of ecoPET – synthetic felt panels manufactured from recycled PET bottles. ecoPET is non-flammable and is characterised by high durability and easy maintenance.

DE Diese Büro-Pendelleuchte verfügt über eine neuartige Funktionsweise, die einer akustischen Fähigkeit und der homogenen Ausleuchtung eines hochwertigen LED-Lichts, das die Ermüdung der Augen minimiert, und die gesunde Atmosphäre eines Arbeitsplatzes prägt. Die blendfreie Pendelleuchte erfüllt hohe technische und ergonomische Anforderungen, geeignet für den Einsatz in Großraumbüros oder Konferenzräumen. Sein Erscheinungsbild strahlt eine formale Schlichtheit aus und vermittelt ein hohes Maß an Eleganz. Die leuchtende Diffusorfläche mit mikroprismatischem Boden ergänzt das Design. Nach einem nachhaltigen Designprinzip besteht Donut aus ecoPET – synthetischen Filzplatten, die aus recycelten PET-Flaschen hergestellt werden. ecoPET ist nicht brennbar und zeichnet sich durch hohe Haltbarkeit und einfache Pflege aus.

Example

Donut	standard power	4000K	no frame	ARCHI felt color 1201 Cloud
↑	↑	↑	↑	↑
2123	- 00	- 2	- 8	- 4
		- 01	- 00	- 3
				- archi1201
	↓	↓	↓	↓
	one size	DALI	luminaire black	pendant up & down

Quickinfo

luminaire size	Ø 1200 × 220
light source size	Ø 600 × 82
system power	48W (↑14W ↓34W)
luminous flux	↑1750lm ↓3500lm
UGR	<17

Technical information

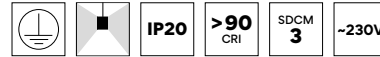

light distribution – up	100°
light distribution – down	95°
luminous efficiency	110lm/W
electrical control	ON/OFF ▲ 9
	DALI ▲ 8
color temperature	3000K ● 3
	4000K ● 4
luminaire color	black ● 01
	white ● 02
fabric color	ARCHI felt ecoPET color palette ◆ archixxx
	archixxx – choose color from page 266

Create my unique code!

2123 - 00 - 2 - ▲ - ● - ◆ - 00 - 3 - ◆

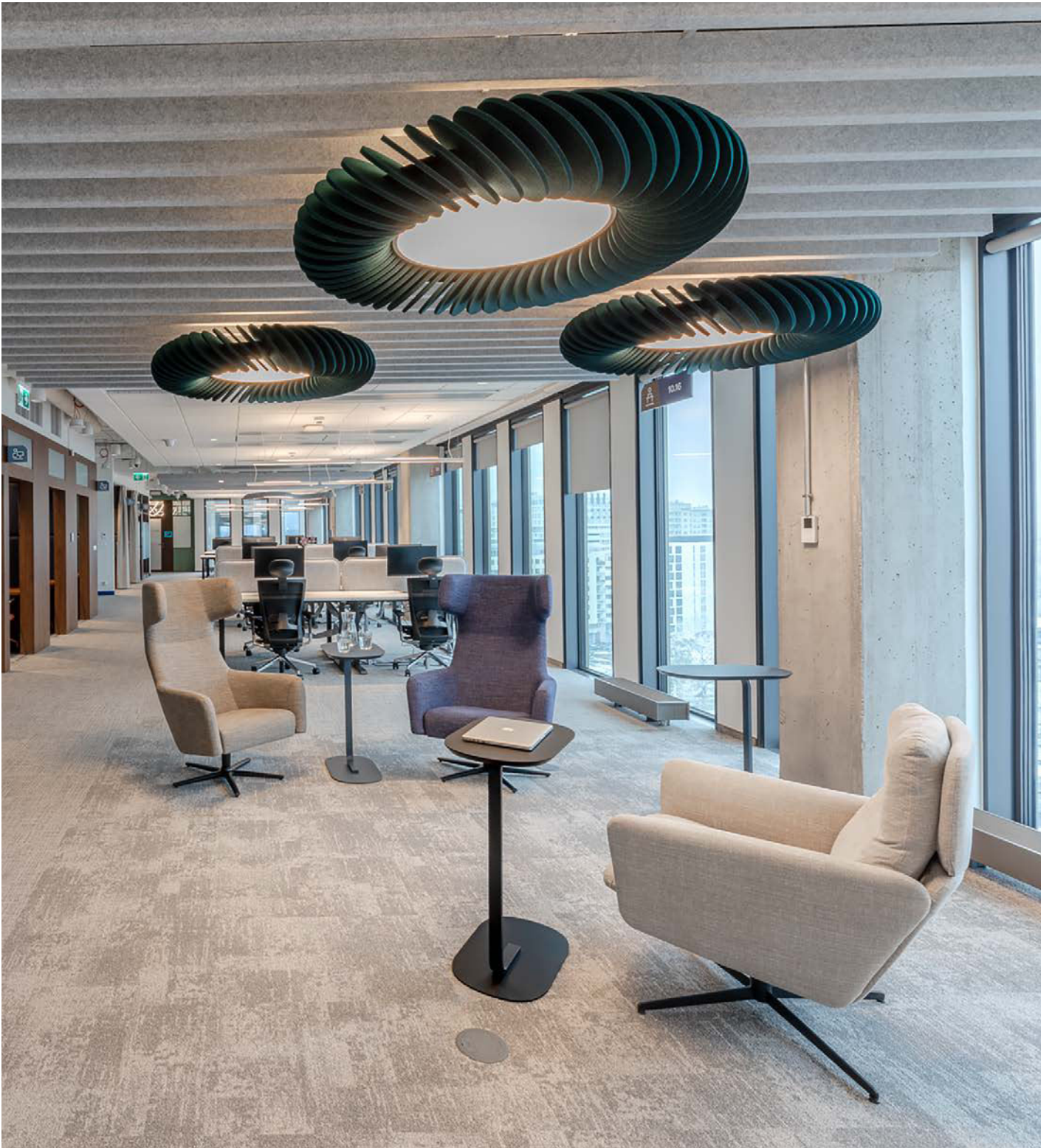

BAT DBS THE DESIGN GROUP

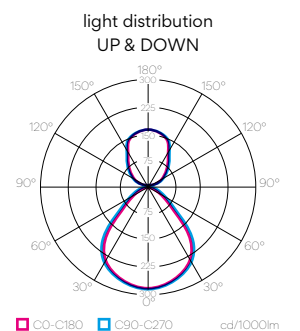
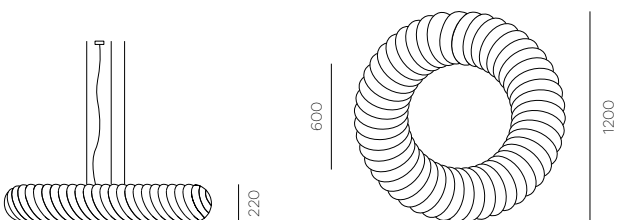

27
PET
BOTTLESup to
1m²ACOUSTIC
SURFACE

Donut Wall

EN Donut wall lamp has emerged due to intensive research on materials with sound-absorbing properties and invisible indirect light sources. The wall lamp is made from a light and thin ecoPET panel with a thickness of 5 mm, which is cut using an innovative laser technique. The cutting motif of concentric circles turns the material from recycled PET bottles into a three-dimensional sculptural object that takes on form and volume only upon wall installation. The interplay with LED light underlines the atmospheric and ambient effect of the Donut wall lamp because the emitted light is 360 degrees. In addition to this appealing effect, the project realises an ecologically responsible approach, which is already evident in the use of sustainably manufactured ecoPET panels and LED as the light source.

DE Donut Wandleuchte ist aus intensiver Forschung an Materialien mit schallabsorbierenden Eigenschaften und unsichtbaren indirekten Lichtquellen entstanden. Die Wandleuchte besteht aus einem leichten und dünnen ecoPET mit einer Dicke von 5 mm, die mit einer innovativen Lasertechnik geschnitten wird. Das Schnittmotiv aus konzentrischen Kreisen verwandelt das Material aus recycelten PET-Flaschen in ein dreidimensionales skulpturales Objekt, das erst durch die Wandmontage, Form und Volumen annimmt. Das Zusammenspiel mit LED-Licht unterstreicht die atmosphärische und raumgreifende Wirkung der Wandleuchte Donut, denn das abgegebene Licht strahlt im Radius von 360 Grad. Neben dieser ansprechenden Wirkung verwirklicht das Projekt einen ökologisch verantwortungsvollen Ansatz, der sich bereits in der Verwendung von nachhaltig hergestellten ecoPET und LED als Lichtquelle zeigt.

Example

Donut Wall	standard power	4000K	no frame	ARCHI felt color 1201 Cloud
↑	↑	↑	↑	↑
2124 - 00	- 2	- 8	- 4	- 01
	- 00	- 00	- 7	- archi1201
↓	↓	↓	↓	
one size	DALI	luminaire black 9005	wall	

Quickinfo

luminaire size	Ø 500×160
system power	4.1W
luminous flux	727lm

Technical information

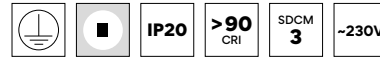

light distribution	360°
luminous efficiency	178lm/W
electrical control	ON / OFF ▲ 9 DALI ▲ 8
color temperature	3000K ● 3 4000K ● 4
luminaire color	black 9005 ◆ 01 white 9010 ◆ 02
fabric color	ARCHI felt ecoPET color palette archixx - choose color from page 266 ◆ archixx

Create my unique code!

2124 - 00 - 2 - ▲ - ● - ◆ - 00 - 7 - ◆

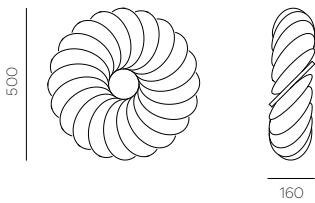

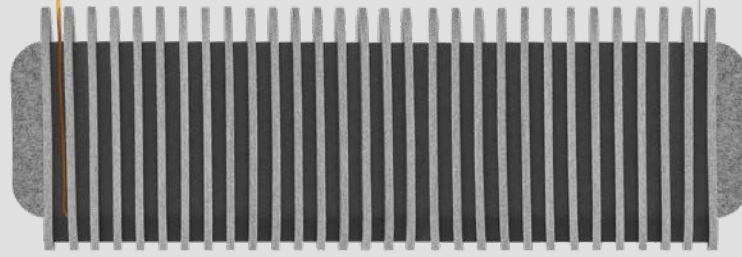
80
PET
BOTTLESup to
3m²ACOUSTIC
SURFACE

Fold

EN The Fold is a pendant lamp that is both a professional light source and a high sound-absorbing acoustic panel. The lamp is equipped with a powerful and energy-efficient linear light fitting. It is only 28 mm wide and incorporates an additional dark optic shutter. The professional quality of the light makes it perfect for office spaces. The high acoustic performance of the lamp makes it a perfect match for demanding spaces. When hung above a desk in an open-office type space, it creates optimal working conditions. It is made from ecoPET – synthetic felt panels manufactured from recycled PET bottles. ecoPET is non-flammable and is characterised by high durability and easy maintenance. It is created from recycled material and is possible to be recycled again.

DE Die Fold ist eine Pendelleuchte, die sowohl eine professionelle Lichtquelle als auch ein hochschallabsorbierendes Akustikpaneel ist. Die Leuchte ist mit einer leistungsstarken und energieeffizienten Linearleuchte ausgestattet. Es ist nur 28mm breit und verfügt über einen zusätzlichen Dark-Optic-Shutter. Die professionelle Qualität des Lichts macht es perfekt für Büroräume. Die hohe akustische Leistung der Lampe macht sie zu einer perfekten Ergänzung für anspruchsvolle Räume. Über einem Schreibtisch in einem Großraumbüro aufgehängt, schafft er optimale Arbeitsbedingungen. Es besteht aus ecoPET – synthetischen Filz, der aus recycelten PET-Flaschen hergestellt wird. ecoPET ist nicht brennbar und zeichnet sich durch hohe Haltbarkeit und einfache Pflege aus. Es wird aus recyceltem Material hergestellt und kann wieder recycelt werden.

Example

Fold	standard power	4000K	dark optics 65° with black reflector	ARCHI felt color 1201 Cloud
↑	↑	↑	↑	↑
2125 - 00	- 2 - 8	- 4 - 01	- 20 - 2 -	archi1201
↓	↓	↓	↓	
one size	DALI	luminaire black 9005	pendant	

Quickinfo

luminaire size	1250×400×120
light source size	1134×28
system power	↓19.6W*
luminous flux	↓2234lm*
UGR	<19

Technical information

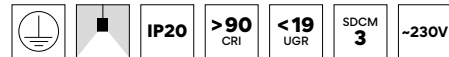

light distribution – down	120° opal	
	60° microprismatic	
	65° dark optics	
	55° dark optics	
luminous efficiency	LO ST HI	
	65° 118lm/W 113lm/W 108lm/W * 55° 117lm/W 112lm/W 107lm/W *	
electrical control	ON / OFF ▲ 9 DALI ▲ 8	
	color temperature	3000K ● 3 4000K ● 4 on request: TUNABLE WHITE ● 9
luminaire color	black 9005 ● 01 white 9010 ● 02	
	optics	opal * 10 microprismatic * 11 dark optics 65° (black reflector) * 20 dark optics 65° (white reflector) * 21 dark optics 65° (silver reflector) * 22 dark optics 55° (black reflector) * 23 dark optics 55° (white reflector) * 24 dark optics 55° (silver reflector) * 25
fabric color		ARCHI felt ecoPET color palette archixxx – choose color from page 266 ◆ archixxx

* Photometric data: dark optics 65°, white reflector, 4000K

Create my unique code!

2125 - 00 - ~ - ▲ - ● - ● - * - 2 - ◆

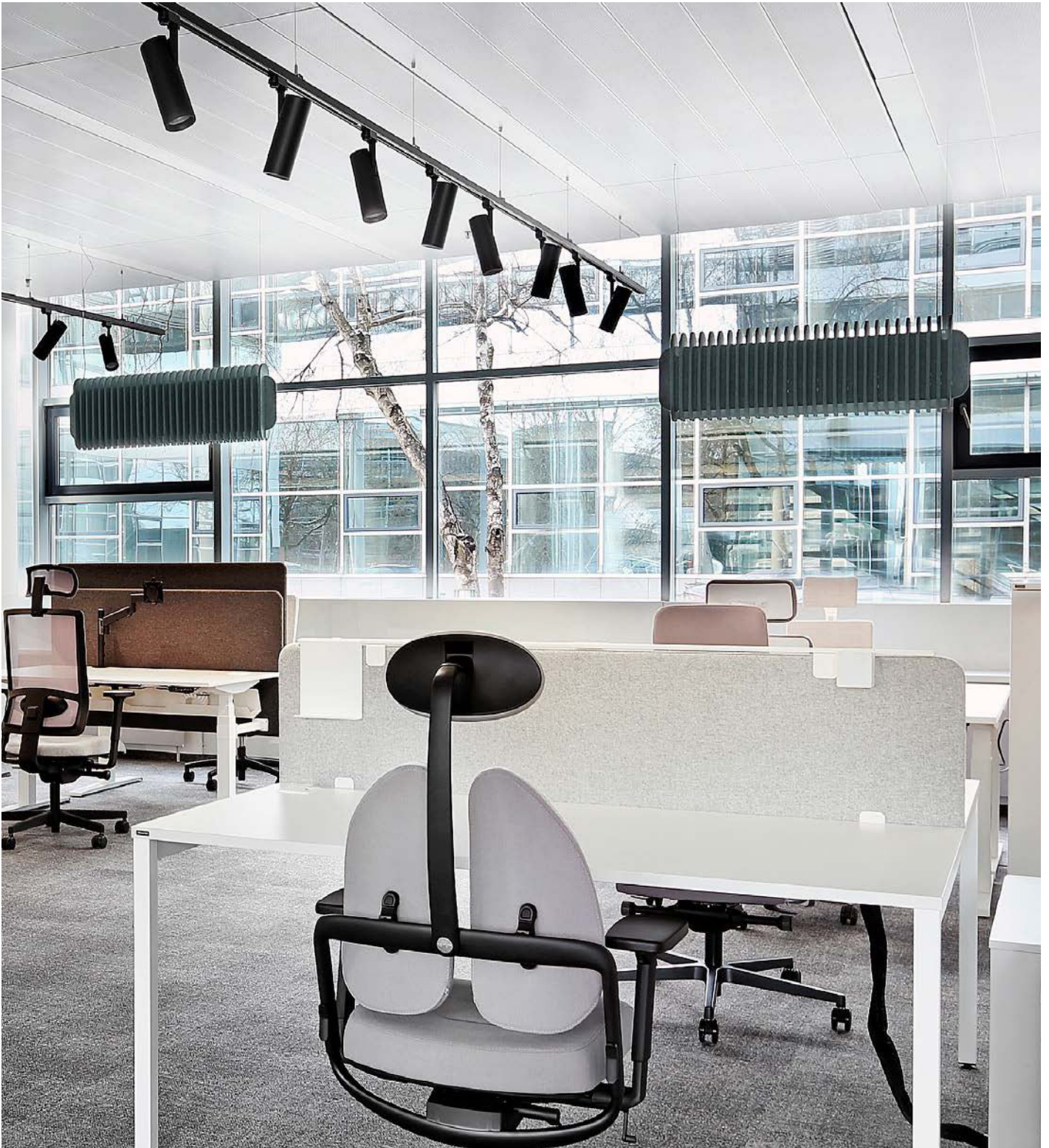

SHOWROOM MUNICH KUSCH+CO NOWY STYL

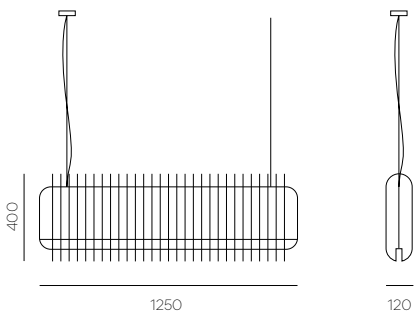

On request we can produce it in other sizes!

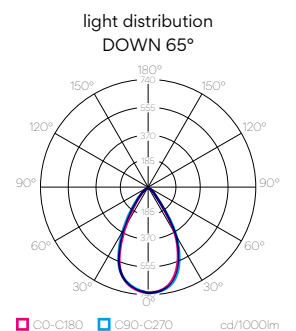
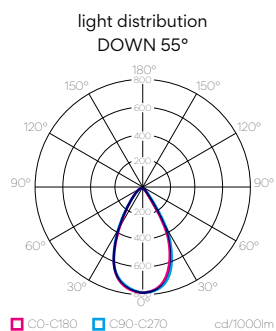

53
PET
BOTTLESup to
2m²ACOUSTIC
SURFACE

Blade 2.0

EN Acoustic Blade 2.0 is an extraordinary acoustic luminaire. By using a PET panel with a large surface area, we have created a lamp that absorbs and isolates a significant proportion of ambient sounds. Due to its form, it can also serve as a partial barrier in open-plan offices. The lamp is equipped with high-quality light sources, making it a perfect fit for workplaces.

DE Acoustic Blade 2.0 ist eine Akustiklampe der besonderen Art. Dank des großflächigen PET-Moduls absorbiert und isoliert diese Lampe einen großen Teil der Umgebungsgläusche. Aufgrund der Form kann das Modell auch als eine Art Teiltrennwand in Open Space-Büroräumen eingesetzt werden. Die Lampe ist mit hochwertigen Lichtquellen ausgestattet und eignet sich daher ideal für den Arbeitsplatz.

Example

Blade 2.0	standard power	4000K	dark optics 65° with black reflector	ARCHI felt color 1201 Cloud
↑	↑	↑	↑	↑
2114 - 01 - 2 - 8 - 4 - 01 - 20 - 2 - archi1201				
	↓	↓	↓	↓
size M	DALI	luminaire black 9005	pendant	

Quickinfo

	Blade 2.0 M ■ 01	Blade 2.0 XL ■ 02
luminaire size	1190×390×53	1750×290×53
light source size	1134×28	1694×28
system power	↓19.6W*	↓29.4W*
luminous flux	↓2234lm*	↓3351lm*
UGR	<19	<19

Technical information

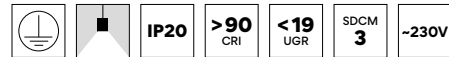

light distribution - down	120° opal		
	60° microprismatic		
	65° dark optics		
	55° dark optics		
luminous efficiency	LO	ST	HI
	65° 118lm/W	113lm/W	108lm/W *
	55° 117lm/W	112lm/W	107lm/W *
electrical control	ON/OFF		▲ 9
	DALI		▲ 8
color temperature	3000K		● 3
	4000K		● 4
	on request: TUNABLE WHITE		● 9
luminaire color	black 9005		◆ 01
	white 9010		◆ 02
optics	opal		* 10
	microprismatic		* 11
	dark optics 65° (black reflector)		* 20
	dark optics 65° (white reflector)		* 21
	dark optics 65° (silver reflector)		* 22
	dark optics 55° (black reflector)		* 23
	dark optics 55° (white reflector)		* 24
dark optics 55° (silver reflector)		* 25	
fabric color	ARCHI felt ecoPET color palette archixxx - choose color from page 266		◆ archixxx

* Photometric data: dark optics 65°, white reflector, 4000K

Create my unique code!

2114 - ■ - ~ - ▲ - ● - ◆ - * - 2 - ◆



ING KATOWICE MAŁECCY BIURO PROJEKTOWE

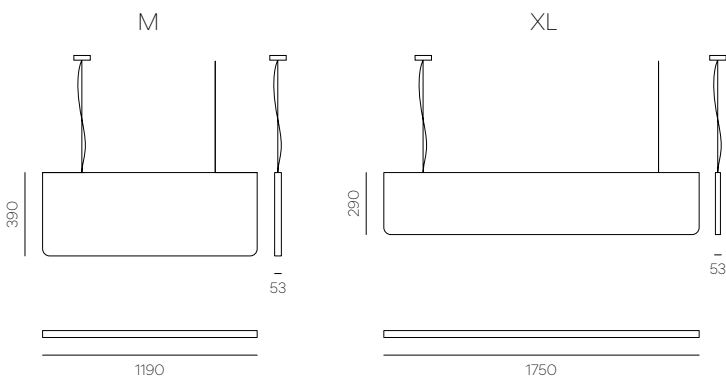

On request we can produce it in other sizes!

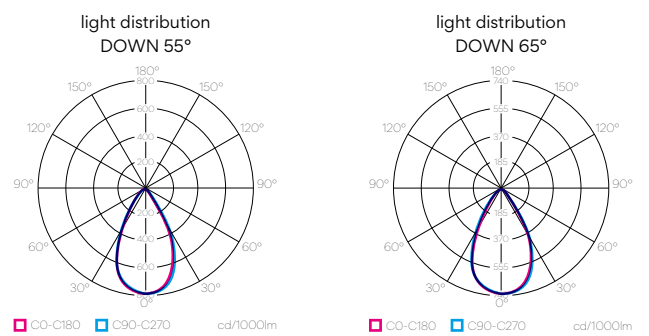

On request upward & downward light distribution possible.



95
PET
BOTTLES

up to
3.60m²
ACOUSTIC
SURFACE



69
PET
BOTTLES

up to
2.60m²
ACOUSTIC
SURFACE

Blade X / Blade Y

EN Blade X and Blade Y are innovative acoustic luminaires designed to address both lighting and sound-absorption needs in various environments, particularly open-plan offices. The X and Y shaped designs, created with three and four PET panels respectively, highlight their unique structure, which allows for efficient absorption of ambient noise. These panels likely consist of sound-absorbing materials to help dampen and minimize unwanted sound reflections, contributing to a quieter and more focused work environment. These luminaires offer high-quality light sources alongside their acoustic features. This means they can provide effective illumination for multiple workstations.

DE Blade X und Blade Y sind innovative Akustikleuchten, die sowohl den Anforderungen an die Beleuchtung als auch an die Schallabsorption in verschiedenen Umgebungen, insbesondere in Großraumbüros, gerecht werden. Die X- und Y-förmigen Designs, die aus drei bzw. vier PET-Paneelen bestehen, heben ihre einzigartige Struktur hervor, die eine effiziente Absorption von Umgebungsgeräuschen ermöglicht. Diese Paneele bestehen wahrscheinlich aus schallabsorbierenden Materialien, die unerwünschte Schallreflexionen dämpfen und minimieren und so zu einer ruhigeren und konzentrierteren Arbeitsumgebung beitragen. Diese Leuchten bieten neben ihren akustischen Eigenschaften auch hochwertige Lichtquellen. Das bedeutet, dass sie eine effektive Beleuchtung für mehrere Arbeitsplätze bieten können.

Create my unique code!

Blade X 2152 - 00 - ~ - ▲ - ● - ◆ - * - 2 - ◆

Blade Y 2153 - 00 - ~ - ▲ - ● - ◆ - * - 2 - ◆

Example

Blade X	standard power	4000K	dark optics 65° with black reflector	ARCHI felt color 1201 Cloud
↑	↑	↑	↑	↑
2152 - 00	- 2 - 8	- 4 - 01	- 20 - 2	- archi1201
↓	↓	↓	↓	↓
one size	DALI	luminaire black 9005	pendant	

Quickinfo

	Blade X	Blade Y
luminaire size	1240×1240×390	1035×1035×390
light source size	4 × 560×28	3 × 560×28
system power	↓39.6W*	↓29.7W*
luminous flux	↓4468lm*	↓3351lm*

Technical information

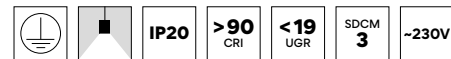

lighting power	low	~ 1	
	standard	~ 2	
	high	~ 3	
light distribution - down	120° opal		
	60° microprismatic		
	65° dark optics		
	55° dark optics		
luminous efficiency	LO	ST	HI
	65° 118lm/W	113lm/W	108lm/W *
	55° 117lm/W	112lm/W	107lm/W *
electrical control	ON/OFF	▲ 9	
	DALI	▲ 8	
color temperature	3000K	● 3	
	4000K	● 4	
	on request: TUNABLE WHITE	● 9	
luminaire color	black 9005	◆ 01	
	white 9010	◆ 02	
optics	opal	* 10	
	microprismatic	* 11	
	dark optics 65° (black reflector)	* 20	
	dark optics 65° (white reflector)	* 21	
	dark optics 65° (silver reflector)	* 22	
	dark optics 55° (black reflector)	* 23	
	dark optics 55° (white reflector)	* 24	
dark optics 55° (silver reflector)	* 25		
fabric color	ARCHI felt ecoPET color palette archixxx - choose color from page 266	◆ archixxx	

* Photometric data: dark optics 65°, white reflector, 4000K

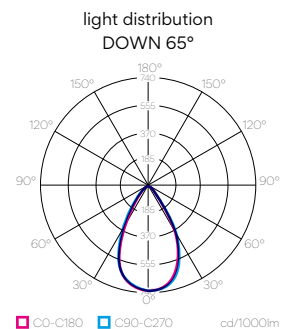
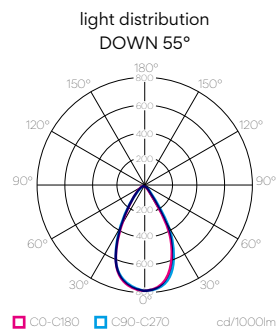
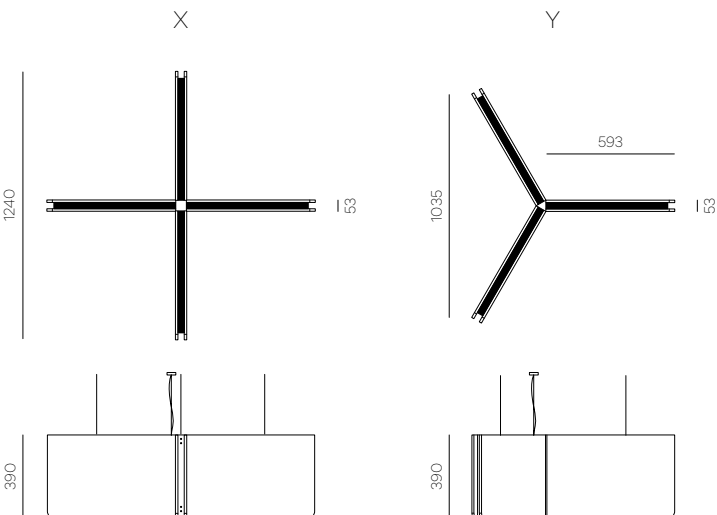

106
PET
BOTTLES



up to
4 m²

ACOUSTIC
SURFACE



Hillock 2.0

EN Developing the Hillock 2.0 pendant luminaire series was aimed to provide excellent visual comfort in the workplace and achieve environmental and economic sustainability with adequate sound absorbing qualities. Each Hillock 2.0 is made of geometrically milled ecoPET panels, which, thanks to the tongue and groove assembly technique, do not require glue or screws. Pushing the material manufactured from recycled PET bottles to the limit of its shapeability, we accomplished a unique contemporary lampshade that exudes timeless aesthetics. The soft direct light it emits is evenly distributed and thus easy on the eyes.

DE Die Entwicklung der Pendelleuchterserie Hillock 2.0 zielte darauf ab, hervorragenden Optischen Komfort am Arbeitsplatz zu bieten und mit angemessenen schallabsorbierenden Eigenschaften ökologische und wirtschaftliche Nachhaltigkeit zu erreichen. Jeder Hillock 2.0 besteht aus geometrisch gefrästen ecoPET-Platten, die dank der Klicksystem weder Klebstoff noch Schrauben benötigen. Wir haben das aus recycelten PET-Flaschen hergestellte Material bis an die Grenze seiner Formbarkeit gebracht und einen einzigartigen, zeitgenössischen Lampenschirm geschaffen, der zeitlose Ästhetik ausstrahlt. Das sanfte, direkte Licht, das sie abgibt, ist gleichmäßig verteilt und schont somit die Augen.

Example

Hillock 2.0	standard power	3000K	no frame	ARCHI felt color 1201 Cloud
↑	↑	↑	↑	↑
2130 - 01 - 2 - 8 - 3 - 02 - 00 - 2 - archi1201				
↓	↓	↓	↓	
size L	DALI	luminaire white	pendant	

Quickinfo

	L	■ 01	XL	■ 02
luminaire size	1000 × 380		1580 × 380	
light source size	Ø400 × 63		2 × Ø400 × 63	
system power	↓29W ↓38W	~ 1 ~ 3	2 × ↓29W 2 × ↓38W	~ 1 ~ 3
luminous flux	↓3300lm ↓4200lm		2 × ↓3300lm 2 × ↓4200lm	

Technical information

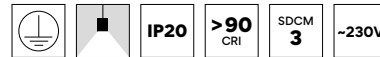

light distribution - down	120°
luminous efficiency	110lm/W
electrical control	ON / OFF ▲ 9 DALI ▲ 8
color temperature	3000K ● 3 4000K ● 4
luminaire color	white
fabric color	ARCHI felt ecoPET color palette ◆ archixxx - choose color from page 266

Create my unique code!

2130 - ■ - ~ - ▲ - ● - 02 - 00 - 2 - ◆

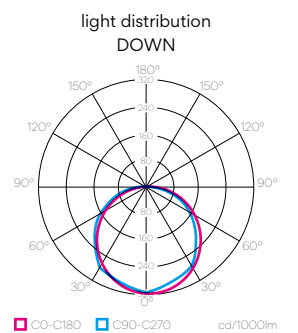
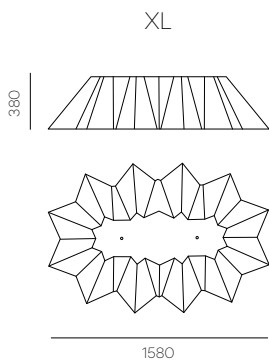
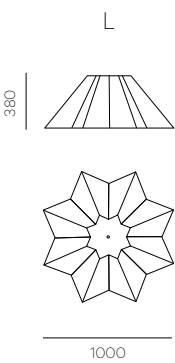

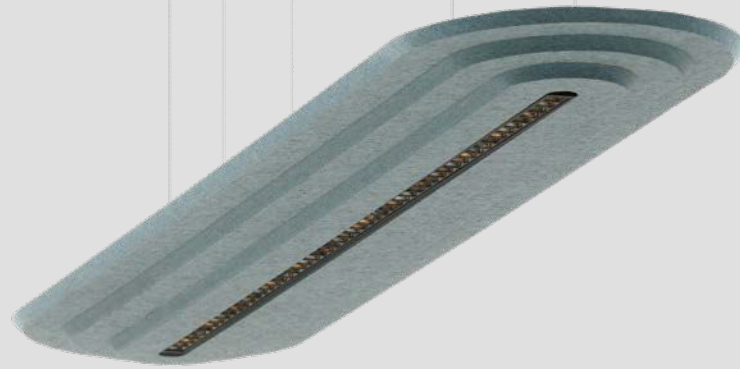
64
PET
BOTTLES↓
PET THICKNESS
36 mm
↑↑
up to
2.4 m²
ACOUSTIC
SURFACE

Linea

EN While creating Linea, we aimed to develop a luminaire that allows users to focus on work. The positive side effect was an increase in productivity and a decrease in stress levels of office workers. The result was a lamp that harmoniously solves open spaces' acoustic problems and illuminates work zones. Linea is a uniquely designed three-layer acoustic horizontal panel with high-quality linear lighting that is subtly blended in the middle of this XXL luminaire. This acoustic luminaire is made of ecoPET, a recycled PET bottle material with exceptional sound absorption properties that supports sustainability.

DE Bei der Entwicklung von Linea wollten wir eine Lampe entwickeln, die es den Benutzern ermöglicht, sich auf die Arbeit zu konzentrieren. Der positive Nebeneffekt war eine Steigerung der Produktivität und eine Verringerung des Stresslevels der Büroangestellten. Das Ergebnis war eine Leuchte, die die akustischen Probleme offener Räume harmonisch löst und Arbeitszonen beleuchtet. Linea ist ein einzigartig gestaltetes dreischichtiges horizontales Akustikpaneel mit hochwertiger linearer Beleuchtung, die sich subtil in die Mitte dieser XXL-Leuchte einfügt. Diese akustische Lampe besteht aus ecoPET, einem recycelten PET-Flaschenmaterial mit außergewöhnlichen Schallabsorptionseigenschaften, das die Nachhaltigkeit unterstützt.

Create my unique code!

2143 - ■ - ~ - ▲ - ○ - ♠ - * - 2 - ◆

Example

Linea	standard power	4000 K	dark optics 65° with black reflector	ARCHI felt color 1201 Cloud
↑	↑	↑	↑	↑
2143	- 01	- 2	- 8	- 4
				- 01
				- 20
				- 2
				- archi1201
	↓	↓	↓	↓
	size S	DALI	luminaire black 9005	pendant

Quickinfo

	S ■ 01	M ■ 02	L ■ 03
luminaire size	1474×340×58	1754×340×58	2034×340×58
light source size	1134×28	1414×28	1694×28
system power	↓19.6W*	↓24.5W*	↓29.4W*
luminous flux	↓2234lm*	↓2792lm*	↓3351lm*

Technical information

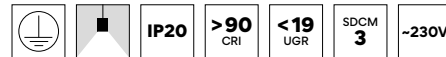

lighting power	low	~ 1		
	standard	~ 2		
	high	~ 3		
light distribution - down	120° opal			
	60° microprismatic			
	65° dark optics			
	55° dark optics			
luminous efficiency	LO	ST	HI	
	65°	118lm/W	113lm/W	108lm/W *
	55°	117lm/W	112lm/W	107lm/W *
electrical control	ON/OFF	▲ 9		
	DALI	▲ 8		
color temperature	3000K	● 3		
	4000K	● 4		
	on request: TUNABLE WHITE	● 9		
luminaire color	black 9005	● 01		
	white 9010	● 02		
optics	opal	* 10		
	microprismatic	* 11		
	dark optics 65° (black reflector)	* 20		
	dark optics 65° (white reflector)	* 21		
	dark optics 65° (silver reflector)	* 22		
	dark optics 55° (black reflector)	* 23		
	dark optics 55° (white reflector)	* 24		
dark optics 55° (silver reflector)	* 25			
fabric color	ARCHI felt ecoPET color palette archixxx - choose color from page 266	◆ archixxx		

* Photometric data: dark optics 65°, white reflector, 4000K

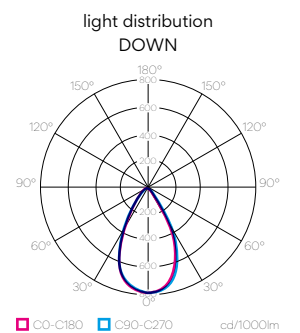
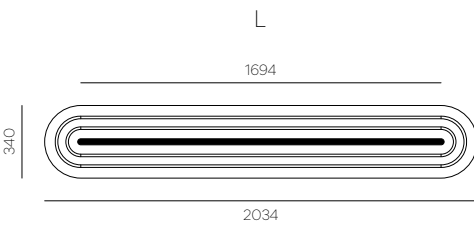
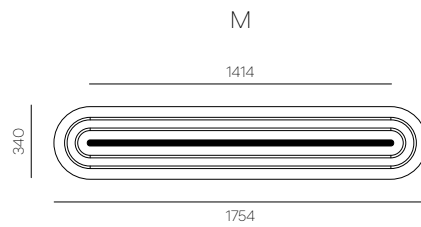
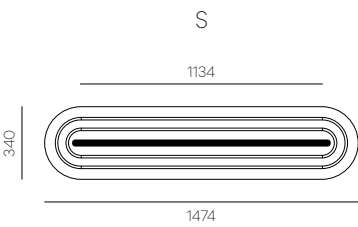

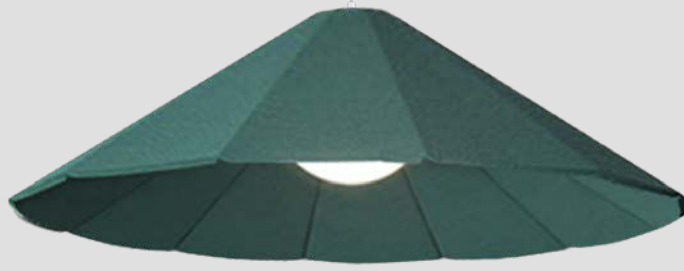
58
PET
BOTTLESup to
2.20m²ACOUSTIC
SURFACE

Cone PET

EN The Cone PET is a contemporary pendant offering a generous amount of direct illumination for shared workspaces, chillout zones, and open-plan offices. The Cone PET luminaires present unusual esthetics and sound dampening properties to increase the sensation of privacy in open-plan offices. The lampshade made from sound-absorbing material from recycled ecoPET has a geometric milled pattern, which creates an exceptional chiaroscuro on the inner of the lampshade when the light is on. The luminaire comes in two sizes and multiple colors for your creatively designed office spaces.

DE Die Cone PET ist eine moderne Pendelleuchte, die eine großzügige Menge an direkter Beleuchtung für gemeinsam genutzte Arbeitsbereiche, Chillout-Zonen und Großraumbüros bietet. Die Cone PET-Leuchten bieten eine außergewöhnliche Ästhetik und schalldämpfende Eigenschaften, um das Gefühl der Privatsphäre in Großraumbüros zu erhöhen. Der Lampenschirm aus schallabsorbierendem Material aus recyceltem ecoPET hat ein geometrisches Fräsmuster, das bei eingeschaltetem Licht ein außergewöhnliches Hell-Dunkel auf der Innenseite des Lampenschirms erzeugt. Die Leuchte ist in zwei Größen und mehreren Farben für Ihre kreativ gestalteten Büroräume erhältlich.

Example

Cone PET	standard power	4000 K	no frame	ARCHI felt color 1201 Cloud
↑	↑	↑	↑	↑
2144 - 01	- 2	- 9	- 4	- 01
				- 00
				- 2
				- archi1201
	↓	↓	↓	↓
	size M	ON / OFF	luminaire black	pendant

Quickinfo

Cone PET M ■ 01
Cone PET L ■ 02
Cone PET XL ■ 03

luminaire size	M Ø750×600 L Ø1000×450 XL Ø1100×200
light source size	Ø300
system power	↓8W
luminous flux	↓1050lm

Technical information

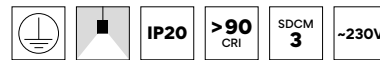

light distribution - down	150°
luminous efficiency	110lm/W
electrical control	ON / OFF
color temperature	3000K ● 3 4000K ● 4
luminaire color	black ● 01 white ● 02 silver ● 04
fabric color	ARCHI felt ecoPET color palette ◆ archixxx archixxx - choose color from page 266

Create my unique code!

2144 - ■ - 2 - 9 - ● - ◆ - 00 - 2 - ◆

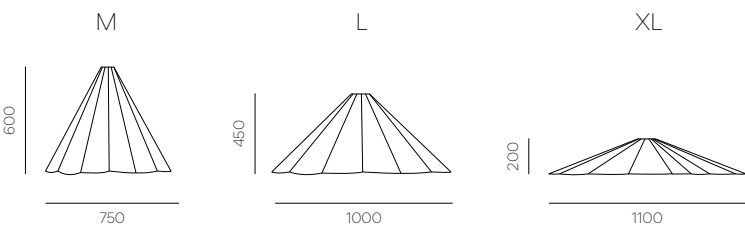

Ceiling Collection

The quality of lighting and acoustic has an enormous influence on office workers' well-being and is a high priority in workplace design. We present a range of ceiling acoustic luminaires that reduce ambient noise and illuminate the room homogeneously. Choose the perfect one from PET Ceilings that focuses on human needs in changing working environments and, last but not least, is made from recycled PET bottles.



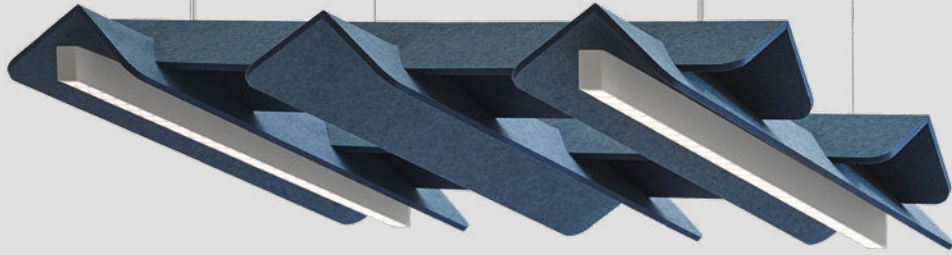

176
PET
BOTTLESup to
6.64 m²ACOUSTIC
SURFACE

Piramid Ceiling

EN Piramid Ceiling is a multifunctional suspended ceiling system that provides top-quality direct lighting and effective sound damping, which is sought-after in the office sector. It is distinguished by a pyramidal arrangement of acoustic baffles arranged alternately lengthwise and crosswise design. The unlit acoustic baffles complement the linear luminaires and add a sound-dampening cover to large ceiling expanses. These stunning sound management solutions use two 4-foot Line 43 linear luminaires. The modern, eco-friendly linear housings are available in fourteen high-quality optics and three color temperatures.

DE Piramid Ceiling ist ein multifunktionales abgehängtes Deckensystem, das eine erstklassige direkte Beleuchtung und effektive Schalldämmung bietet, die im Bürobereich gefragt ist. Es zeichnet sich durch eine pyramidenförmige Anordnung von Schallwänden aus, die abwechselnd längs und quer angeordnet sind. Die unbeleuchteten Akustikbaffeln ergänzen die Langfeldleuchten und fügen großen Deckenflächen eine schalldämpfende Hülle hinzu. Diese atemberaubenden Soundmanagement-Lösungen verwenden zwei 4-Fuß-Line 43-Linearleuchten. Die modernen, umweltfreundlichen Lineargehäuse gibt es in vierzehn hochwertigen Optiken und drei Farbtemperaturen.

Example

Piramid Ceiling	standard power	4000 K	dark optics 80° with black reflector	ARCHI felt color 1201 Cloud
↑	↑	↑	↑	↑
2140 - 00	- 2	- 8	- 4 - 01	- 40 - 2 - archi1201
↓	↓	↓	↓	↓
one size	DALI	luminaire black 9005	pendant	

Quickinfo

luminaire size	1190 × 1480 × 210
light source size	2 × 1136 × 43
system power	2 × ↓19.6W*
luminous flux	2 × ↓2234lm*

Technical information

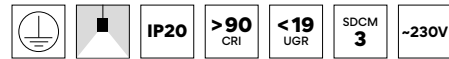

light distribution - down	120° opal	
	60° microprismatic	
	80° / 50° / 35° dark optics	
luminous efficiency	117lm/W*	
electrical control	ON/OFF	▲ 9
	DALI	▲ 8
color temperature	3000K	● 3
	4000K	● 4
	on request: TUNABLE WHITE	● 9
luminaire color	black 9005	◆ 01
	white 9010	◆ 02
	on request: RAL color palette	◆ 99
optics	opal	* 10
	microprismatic	* 11
	dark optics 80° (black reflector)	* 40
	dark optics 80° (white reflector)	* 41
	dark optics 80° (silver reflector)	* 42
	dark optics 50° (black reflector)	* 43
	dark optics 50° (white reflector)	* 44
	dark optics 50° (silver reflector)	* 45
	dark optics 35° (black reflector)	* 46
	dark optics 35° (white reflector)	* 47
	dark optics 35° (silver reflector)	* 48
fabric color	ARCHI felt ecoPET color palette	◆ archixxx
	archixxx - choose color from page 266	

* Photometric data: dark optics 80°, white reflector, 4000K

Create my unique code!

2140 - 00 - ~ - ▲ - ● - ◆ - * - 2 - ◆

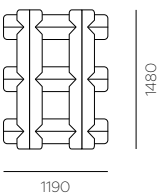
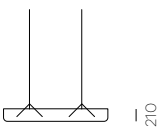

light distribution
DOWN

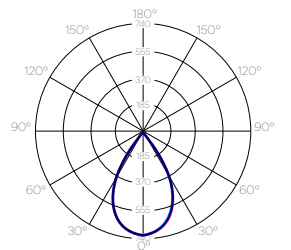

■ C0-C180 ■ C90-C270 cd/1000lm

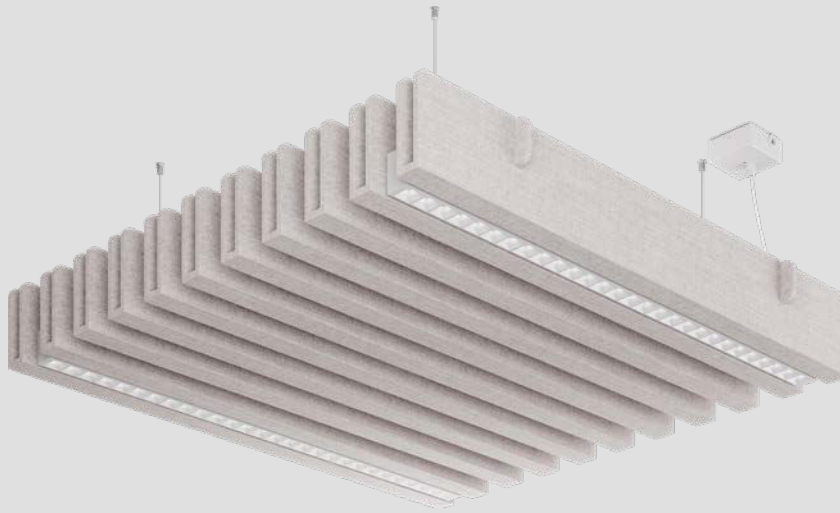
178
PET
BOTTLESup to
6.70m²ACOUSTIC
SURFACE

Simple Ceiling 2.0

EN The pendant luminaire Simple Ceiling 2.0 represents an exquisite and effective union of environmentally conscious room acoustics with aesthetic design. The linear light source of this direct and indirect luminaire is suspended between twelve U-shaped ecoPET panels, leaving a layer of air between the components to help with sound absorption. The fixture has a noise reduction coefficient of one and utilizes a microstructure diffuser to eliminate glare.

DE Die Pendelleuchte Simple Ceiling 2.0 steht für eine exquisite und wirkungsvolle Verbindung umweltbewusster Raumakustik mit ästhetischem Design. Die lineare Lichtquelle dieser Direkt- und Indirektleuchte ist zwischen zwölf U-förmigen ecoPET-Paneele aufgehängt, wodurch eine Luftschicht zwischen den Komponenten verbleibt, um die Schallabsorption zu unterstützen. Die Leuchte hat einen Rauschunterdrückungskoeffizienten der Stufe eins und verwendet einen Mikrostruktur-Diffusor, um Blendung zu eliminieren.

Example

Simple Ceiling 2.0	standard power	4000K	dark optics 80° with black reflector	ARCHI felt color 1201 Cloud
↑	↑	↑	↑	↑
2139 - 00	- 2	- 8	- 4 - 01	- 40 - 2 - archi1201
↓	↓	↓	↓	↓
one size	DALI	luminaire black 9005	pendant	

Quickinfo

luminaire size	1195 × 1195 × 158
light source size	2 × 1136 × 43
system power	2 × ↓19.6W*
luminous flux	2 × ↓2312lm*

Technical information

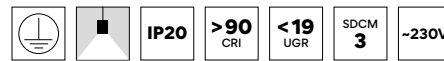

light distribution - down	120° opal	
	60° microprismatic	
	80° / 50° / 35° dark optics	
luminous efficiency	117lm/W*	
electrical control	ON / OFF	▲ 9
	DALI	▲ 8
color temperature	3000K	● 3
	4000K	● 4
	on request: TUNABLE WHITE	● 9
luminaire color	black 9005	◆ 01
	white 9010	◆ 02
	on request: RAL color palette	◆ 99
optics	opal	* 10
	microprismatic	* 11
	dark optics 80° (black reflector)	* 40
	dark optics 80° (white reflector)	* 41
	dark optics 80° (silver reflector)	* 42
	dark optics 50° (black reflector)	* 43
	dark optics 50° (white reflector)	* 44
	dark optics 50° (silver reflector)	* 45
	dark optics 35° (black reflector)	* 46
	dark optics 35° (white reflector)	* 47
	dark optics 35° (silver reflector)	* 48
fabric color	ARCHI felt ecoPET color palette archixxx - choose color from page 266	◆ archixxx

* Photometric data: dark optics 80°, white reflector, 4000K

Create my unique code!

2139 - 00 - ~ - ▲ - ● - ◆ - * - 2 - ◆

178
PET
BOTTLESup to
6.70m²ACOUSTIC
SURFACE

Systema Ceiling

EN This modular acoustic ceiling system inspires with various shapes, sizes, and finishes, encouraging creative lighting in the office space. The wide range of modules thus enables different combinations that offer full functionality, provide maximum lighting comfort, and, most importantly, reduce ambient noise. Interior designers can choose from a wide range of longitudinal, oval, and circular acoustic panels but also modules with a flushed linear luminaire that gives direct light. The multifunctional ceiling system can be expanded as desired and linked with smart lighting control technology.

DE Dieses modulare Akustikdeckensystem begeistert mit verschiedenen Formen, Größen und Ausführungen, und fördert die kreative Beleuchtung im Bürobereich. Die große Auswahl an Modulen ermöglicht somit unterschiedliche Kombinationen, die volle Funktionalität bieten, für maximalen Lichtkomfort sorgen und vor allem Umgebungsgeräusche reduzieren. Innenarchitekten können aus einer breiten Palette von länglichen, ovalen und runden Akustikplatten wählen, aber auch aus Modulen mit einer bündigen Langfeldleuchte, die direktes Licht spendet. Das multifunktionale Deckensystem lässt sich beliebig erweitern und mit smarter Lichtsteuerungstechnik verknüpfen.

Example

Systema Ceiling	standard power	4000K	dark optics 80° with black reflector	ARCHI felt color 1201 Cloud
↑	↑	↑	↑	↑
2132 - 00	- 2 - 8	- 4 - 01	- 40 - 2 -	archi1201
↓	↓	↓	↓	
one size	DALI	luminaire black 9005	pendant	

Don't forget:

Choose your luminaire panel (smooth or vcut) and acoustic panel set (A, B, C, D, E) from the next page!

Quickinfo

luminaire size	1200×1224×190
light source size	2 × 1136×43
system power	2 × ↓19.6W*
luminous flux	2 × ↓2312lm*

Technical information

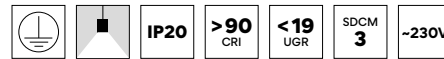

light distribution - down	120° opal
	60° microprismatic
	80° / 50° / 35° dark optics
	asymetric - wall washer
luminous efficiency	117lm/W*
electrical control	ON / OFF ▲ 9
	DALI ▲ 8
color temperature	3000K ● 3
	4000K ● 4
	on request: TUNABLE WHITE ● 9
luminaire color	black 9005 ● 01
	white 9010 ● 02
	on request: RAL color palette ● 99
optics	opal * 10
	microprismatic * 11
	dark optics 80° (black reflector) * 40
	dark optics 80° (white reflector) * 41
	dark optics 80° (silver reflector) * 42
	dark optics 50° (black reflector) * 43
	dark optics 50° (white reflector) * 44
	dark optics 50° (silver reflector) * 45
	dark optics 35° (black reflector) * 46
	dark optics 35° (white reflector) * 47
	dark optics 35° (silver reflector) * 48
	wall washer * 49
fabric color	ARCHI felt ecoPET color palette ◆ archixxx
	archixxx - choose color from page 266

* Photometric data: dark optics 80°, white reflector, 4000K

Create my unique code!

2132 - 00 - ~ - ▲ - ● - ◆ - * - 2 - ◆

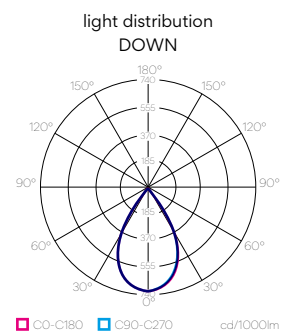
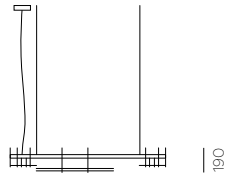
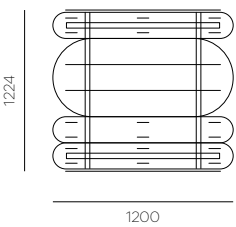

Create out unique Systema Ceiling!

Every Systema Ceiling starts with a base:

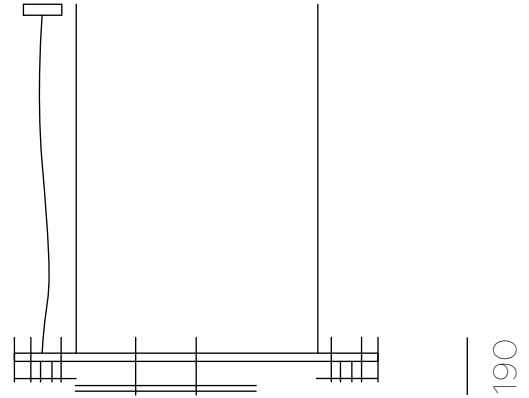
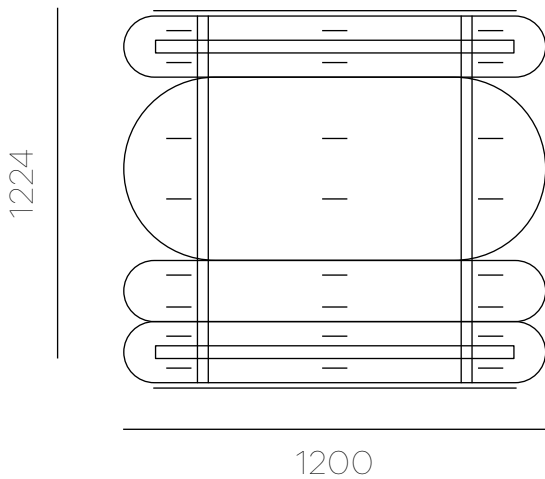

Create my unique code!

2132 - 00 - 2 - ▲ - ● - ◆ - * - 2 - ◆

STEP 1 Choose the luminaire panel:



Smooth luminaire panel

Order code: 2133

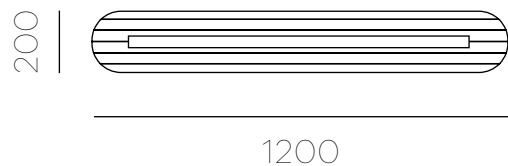

Vcut luminaire panel

Order code: 2134

STEP 2 Choose the layout of the wide acoustic panels:

Acoustic panel set A

Order code: 2135

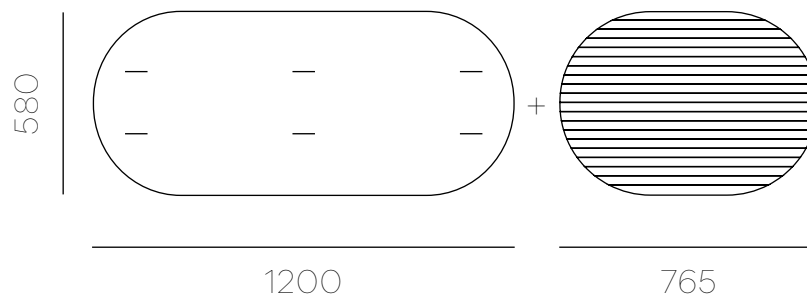

Acoustic panel set B

Order code: 2136

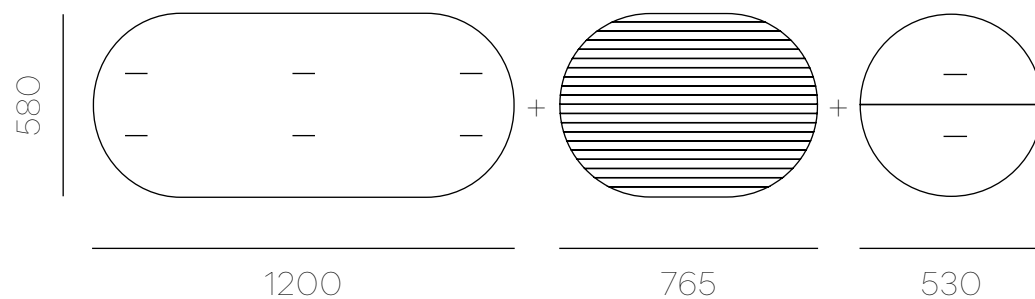

Acoustic panel set C

Order code: 2137

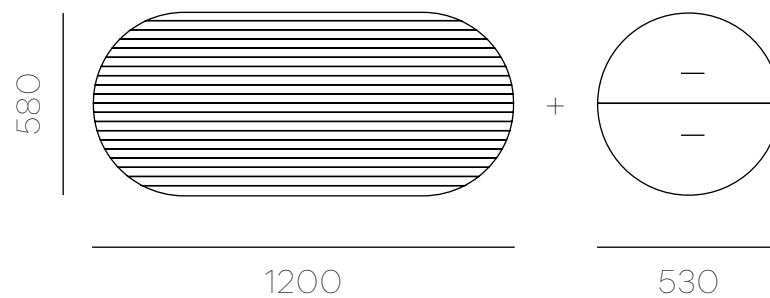

Acoustic panel set D

Order code: 2138

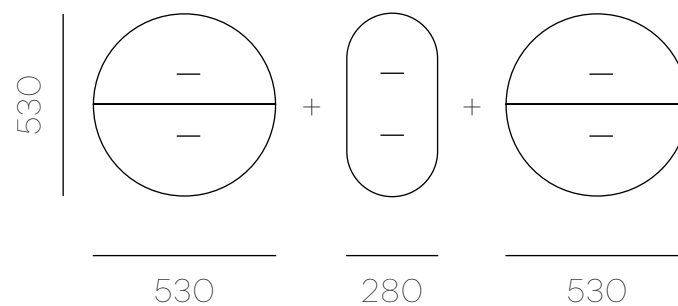

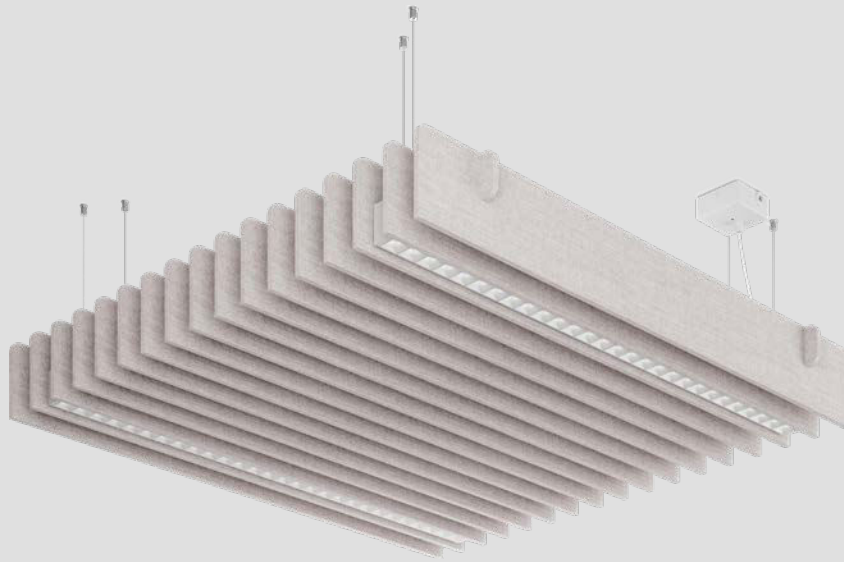
176
PET
BOTTLESup to
6.66m²ACOUSTIC
SURFACE

Verti Ceiling 2.0

EN Verti Ceiling 2.0 is the aesthetically appealing ceiling-light combination comprising the fourteen vertical acoustic baffles and integrated linear luminaire that delivers an unlimited range of design options. This pendant ceiling luminaire reduces the sound level in spacious offices and exudes a presence that impresses beholders with its dynamic appeal. Application of high-performance linear luminaire Line 43 offers superior performance, and all fourteen versions of available optics provide uniform illumination. Four feet long light source is hidden between the baffles to redirect light downwards and to create ambient, glare-free from any angle illumination.

DE Verti Ceiling 2.0 ist die ästhetisch ansprechende Decken-Licht-Kombination aus vierzehn vertikalen Akustiklamellen und integrierter Langfeldleuchte, die unbegrenzte Gestaltungsmöglichkeiten bietet. Diese Decken-Pendelleuchte reduziert den Schallpegel in großzügigen Büros und strahlt eine Präsenz aus, die durch ihre dynamische Anmutung beeindruckt. Der Einsatz der Hochleistungs-Langfeldleuchte Line 43 bietet überlegene Leistung, und alle vierzehn Versionen der verfügbaren Optiken sorgen für eine gleichmäßige Beleuchtung. Eine 1,20 m lange Lichtquelle ist zwischen den Blenden verborgen, um das Licht nach unten umzulenken und eine Umgebungsbeleuchtung zu schaffen, die aus jedem Winkel blendfrei ist.

Example

Verti Ceiling 2.0	standard power	4000K	dark optics 80° with black reflector	ARCHI felt color 1201 Cloud
↑	↑	↑	↑	↑
2141 - 00	- 2 - 8	- 4 - 01	- 40 - 2 -	archi1201
	↓	↓	↓	↓
	one size	DALI	luminaire black 9005	pendant

Quickinfo

luminaire size	1195 × 1195 × 150
light source size	2 × 1136 × 43
system power	2 × ±19.6W*
luminous flux	2 × ±2312lm*

Technical information

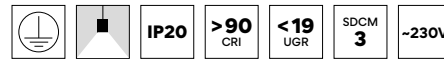

light distribution - down	120° opal	
	60° microprismatic	
	80° dark optics	
	50° dark optics	
	35° dark optics	
luminous efficiency	117lm/W*	
electrical control	ON / OFF	▲ 9
	DALI	▲ 8
color temperature	3000K	● 3
	4000K	● 4
on request:	TUNABLE WHITE	● 9
luminaire color	black 9005	◆ 01
	white 9010	◆ 02
on request:	RAL color palette	◆ 99
optics	opal	* 10
	microprismatic	* 11
	dark optics 80° (black reflector)	* 40
	dark optics 80° (white reflector)	* 41
	dark optics 80° (silver reflector)	* 42
	dark optics 50° (black reflector)	* 43
	dark optics 50° (white reflector)	* 44
	dark optics 50° (silver reflector)	* 45
	dark optics 35° (black reflector)	* 46
	dark optics 35° (white reflector)	* 47
	dark optics 35° (silver reflector)	* 48
	fabric color	ARCHI felt ecoPET color palette archixxx - choose color from page 266

* Photometric data: dark optics 80°, white reflector, 4000K

Create my unique code!

2141 - 00 - ~ - ▲ - ● - ◆ - * - 2 - ◆

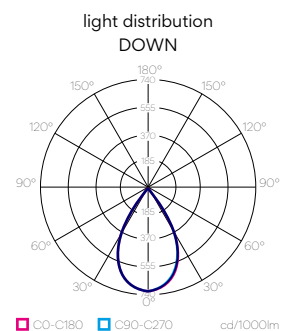
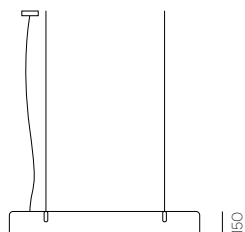
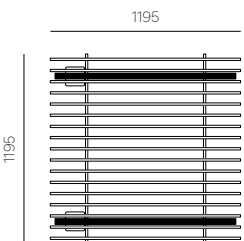

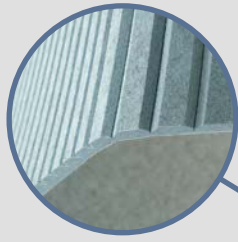
76
PET
BOTTLESup to
2.87m²
ACOUSTIC
SURFACE

Alpha

EN Acoustic Alpha is an oversized trapeze-shaped, highly effective office lamp made of sound-absorbing material from recycled PET bottles. The lamp design stands out with clean lines and a minimalist design. Alpha is made of sound-absorbing material made from recycled PET bottles, which is eco-friendly and helps reduce noise in the workplace. The Alpha luminaire provides bright and efficient lighting suitable for an office environment, with adjustable brightness settings to suit different needs. It uses LED technology to consume less energy and reduce environmental impact. The lamp is designed to be sturdy and durable, with a long lifespan and low maintenance requirements. The Alpha lamp can be controlled via a mobile app or remote control, allowing users to adjust the brightness and color temperature of the light to suit their needs.

DE Acoustic Alpha ist eine überdimensionale, trapezförmige, hocheffektive Büroleuchte aus schallabsorbierendem Material aus recycelten PET-Flaschen. Das Lampendesign zeichnet sich durch klare Linien und ein minimalistisches Design aus. Alpha besteht aus schallabsorbierendem Material aus recycelten PET-Flaschen, das umweltfreundlich ist und zur Reduzierung von Lärm am Arbeitsplatz beiträgt. Die Alpha-Leuchte bietet eine helle und effiziente Beleuchtung, die für eine Büroumgebung geeignet ist, mit einstellbaren Helligkeitseinstellungen, um verschiedenen Anforderungen gerecht zu werden. Es verwendet LED-Technologie, um weniger Energie zu verbrauchen und die Umweltbelastung zu reduzieren. Die Lampe ist robust und langlebig, mit langer Lebensdauer und geringem Wartungsaufwand. Die Alpha-Lampe kann über eine mobile App oder Fernbedienung gesteuert werden, sodass Benutzer die Helligkeit und Farbtemperatur des Lichts an ihre Bedürfnisse anpassen können.

Example

Alpha	standard power	4000 K	no frame	ARCHI felt color 1201 Cloud
↑	↑	↑	↑	↑
2148	- 01	- 2	- 8	- 4
				- 02
				- 00
				- 2
				- archi1201
	↓	↓	↓	↓
	size M	DALI	luminaire white 9010	pendant

Quickinfo

	Alpha M ■ 01	Alpha L ■ 02
luminaire size	660×660×385	860×860×530
light source size	320×320	600×600
system power	↓10 W LO ↓15 W ST ↓20 W HI	~ 1 ~ 2 ~ 3
luminous flux	↓1200 lm ↓1800 lm ↓2400 lm	~ 2 ~ 3
light distribution - down	150°	90°
UGR		<19

Technical information

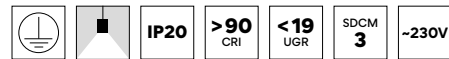

luminous efficiency	120 lm/W
electrical control	ON / OFF ▲ 9 DALI ▲ 8
color temperature	3000 K ● 3 4000 K ● 4 6000 K ● 6
luminaire color	white
fabric color	ARCHI felt ecoPET color palette archixxx - choose color from page 266 ◆ archixxx

Create my unique code!

2148 - ■ - ~ - ▲ - ● - 02 - 00 - 2 - ◆



M

L

660

860

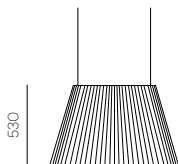
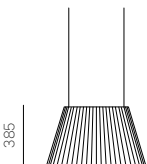
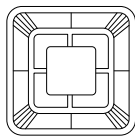
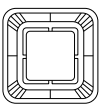

385

530

M

L

light distribution
DOWN

light distribution
DOWN - Alpha L

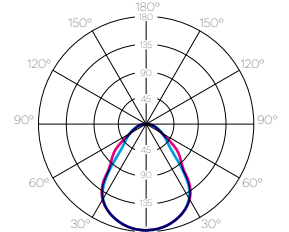
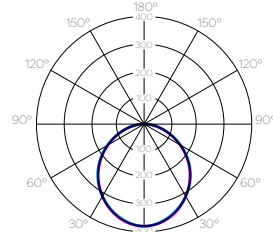

CO-C180 C90-C270 cd/1000lm

CO-C180 C90-C270 cd/1000lm

59
PET
BOTTLESup to
2.23m²ACOUSTIC
SURFACE

Alpha Duo

EN The Alpha Duo is a generously proportioned trapeze-shaped lamp, boasting a larger size than its counterparts. The lamp's design is crafted with simplicity in mind. Constructed from sound-absorbing material derived from recycled PET bottles, Alpha is both environmentally friendly and contributes to noise reduction in workspaces. This luminaire offers bright and efficient lighting ideal for office environments, featuring adjustable brightness settings to accommodate various needs. LED technology reduces energy consumption and has positive impact on environment.

DE Die Alpha Duo ist eine großzügig bemessene trapezförmige Leuchte, die größer ist als ihre Pendants. Das Design der Leuchte ist auf Schlichtheit ausgelegt. Hergestellt aus schallabsorbierendem Material, das aus recycelten PET-Flaschen gewonnen wird, ist Alpha umweltfreundlich und trägt zur Lärmreduzierung in Arbeitsräumen bei. Diese Leuchte bietet eine helle und effiziente Beleuchtung, die sich ideal für Büroumgebungen eignet, und verfügt über einstellbare Helligkeitseinstellungen, um verschiedenen Anforderungen gerecht zu werden. Die LED-Technologie reduziert den Energieverbrauch und hat positive Auswirkungen auf die Umwelt.

Example

Alpha Duo	standard power	4000 K	no frame	ARCHI felt color 1201 Cloud
↑	↑	↑	↑	↑
2149 - 00	- 2	- 8	- 4	- 02 - 00 - 2 - archi1201
↓	↓	↓	↓	
one size	DALI	luminaire white 9010	pendant	

Quickinfo

luminaire size	660×1070×385		
light source size	2 pcs 320×320		
system power	2 × ↕10W LO	~	1
	2 × ↕15W ST	~	2
	2 × ↕20W HI	~	3
luminous flux	2 × ↕1200lm		
	2 × ↕1800lm		
	2 × ↕2400lm		
light distribution - down	150°		

Technical information

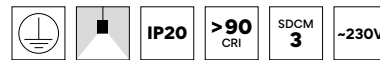

luminous efficiency	120lm/W	
electrical control	ON / OFF	▲ 9
	DALI	▲ 8
color temperature	3000K	● 3
	4000K	● 4
	6000K	● 6
luminaire color	white	
fabric color	ARCHI felt ecoPET color palette archixxx - choose color from page 266	◆ archixxx

Create my unique code!

2149 - 00 - ~ - ▲ - ● - 02 - 00 - 2 - ◆

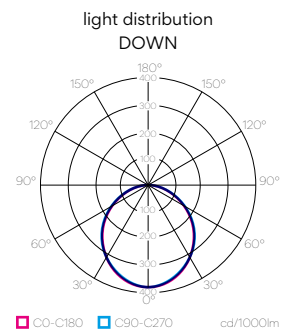
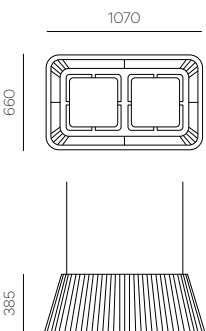

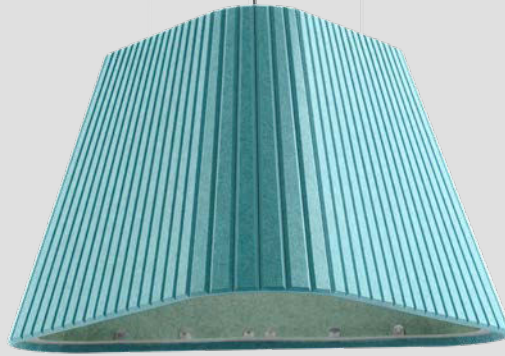
65
PET
BOTTLESup to
2.47m²
ACOUSTIC
SURFACE

Alpha Triangle

EN Alpha Triangle is a contemporary lamp featuring a sleek prism-shaped design, drawing inspiration from the innovative Acoustic Alpha. This lamp embodies a sophisticated and geometric aesthetic. The silhouette, reminiscent of a prism, exudes modernity with its clean lines and minimalist structure. Alpha Triangle is engineered to deliver bright and efficient lighting, making it an ideal addition to office environments. Its adjustable brightness settings cater to diverse needs, ensuring a personalized and comfortable illumination experience. Employing cutting-edge LED technology, this lamp remains energy-efficient, promoting a reduced environmental footprint.

DE Alpha Triangle ist eine moderne Leuchte mit einem eleganten prismenförmigen Design, das von der innovativen Acoustic Alpha inspiriert ist. Diese Leuchte verkörpert eine anspruchsvolle und geometrische Ästhetik. Die Silhouette, die an ein Prisma erinnert, strahlt mit ihren klaren Linien und der minimalistischen Struktur Modernität aus. Alpha Triangle wurde entwickelt, um eine helle und effiziente Beleuchtung zu liefern, was sie zu einer idealen Ergänzung für Büroumgebungen macht. Die einstellbaren Helligkeitsstufen passen sich den unterschiedlichen Bedürfnissen an und sorgen für ein individuelles und angenehmes Beleuchtungserlebnis. Durch den Einsatz modernster LED-Technologie ist diese Leuchte energieeffizient und schützt so die Umwelt.

Example

Alpha Triangle	standard power	3000K	no frame	ARCHI felt color 1201 Cloud
↑	↑	↑	↑	↑
2164 - 01	- 2	- 8	- 3	- 02
				- 00
				- 2
				- archi1201
	↓	↓	↓	↓
	size L	DALI	luminaire white	pendant

Quickinfo

	Alpha Triangle L ■ 01	Alpha Triangle XL ■ 02
luminaire size	950 × 860 × 540	1150 × 1045 × 650
light source size	A Ø 320 × 57	Ø 320 × 57
	B Ø 450 × 82	Ø 450 × 82
system power	A ↓10W LO ~ 1 ↓15W ST ~ 2 ↓20W HI ~ 3	
	B 30W (↑9W ↓21W)	
luminous flux	A ↓1200lm ↓1800lm ↓2400lm	
	B ↑1000lm ↓2100lm	
UGR	B <19	<19

Technical information

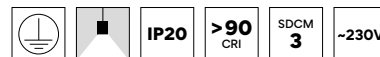

light distribution - down	A 150°	
	B 95°	
light distribution - up	B 150°	
luminous efficiency	A 120lm/W	
	B 110lm/W	
electrical control	ON/OFF ▲ 9	
	DALI ▲ 8	
color temperature	A 3000K ● 3	
	4000K ● 4	
	6000K ● 6	
luminaire color	B 3000K ● 3	
	4000K ● 4	
luminaire color	B black ● 01	
	A B white ● 02	
fabric color	ARCHI felt ecoPET color palette archixxx - choose color from page 266	◆ archixxx

Create my unique code!

2164 - 00 - ~ - ▲ - ● - 02 - 00 - 2 - ◆

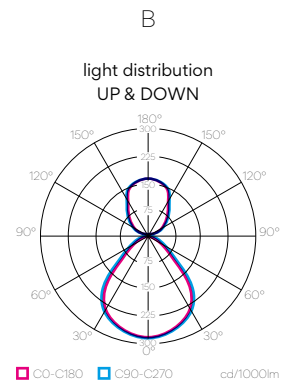
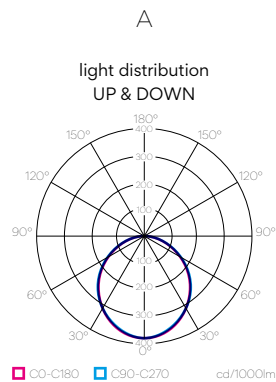
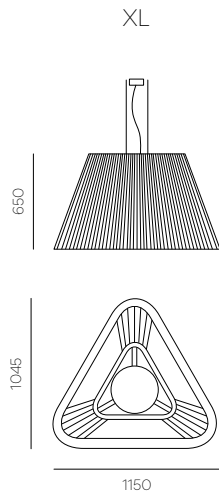
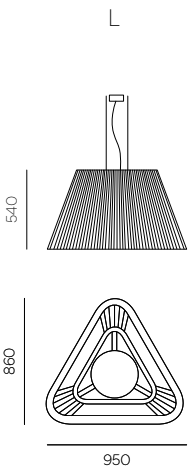



Dot System

EN Line 28 Dot System is an imposing pendant luminaire that fascinates its sculptural look and allows for a versatile range of arrangements. While it exudes a relatively lightweight look as a single structure linked in the shape of a triangle or square, it reveals a distinctive sculptural effect when arranged in a monumental geometric hexagon scheme. The structure of each Dot System luminaire consists of three or four sections of the Line 28 profile equipped with advanced optics, which are connected in a triangle or square shape through cylindrical „Dot“ connectors. Suppose you want to improve the acoustics of your office space additionally. In that case, it is possible to fill the distance between the elements of the Dot System with a high-quality sound-absorbing panel.

DE Line 28 Dot System ist eine imposante Pendelleuchte, die durch ihre skulpturale Anmutung fasziniert und vielseitig arrangiert werden kann. Während es als einzelne Struktur die in Form eines Dreiecks oder Quadrats verbunden ist, ein relativ leichtes Aussehen ausstrahlt, zeigt es einen unverwechselbaren skulpturalen Effekt, wenn es in einem monumentalen geometrischen Hexagon-Schema angeordnet ist. Die Struktur jeder Dot System-Leuchte besteht aus drei oder vier Abschnitten des Line 28-Profiles, das mit fortschrittlicher Optik ausgestattet ist und durch zylindrische „Dot“-Verbindungsstücke in Dreiecks- oder Quadratform verbunden ist. Angenommen, Sie möchten die Akustik Ihrer Büroräume zusätzlich verbessern. In diesem Fall ist es möglich, den Abstand zwischen den Elementen des Dot-Systems mit einer hochwertigen schallabsorbierenden Paneel zu füllen.

Create my unique code!

For possible configuration options visit pages 220 – 221 of the catalog.

Quickinfo	LO	ST	HI
system power	↓9.6W	↓19.6W	↓30W
luminous flux	65° ↓1141lm	↓2234lm	↓3259lm *
	55° ↓1127lm	↓2205lm	↓3217lm *
	up ↑1062lm	↑2079lm	↑3034lm *
UGR	<19	<19	<19

Technical information

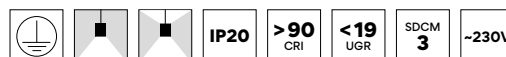

lighting power	low	~ 1	
	standard	~ 2	
	high	~ 3	
mounting type	pendant	+ 2	
	pendant up & down	+ 3	
light distribution - up	~145° x 100°		
light distribution - down	65° / 55°		
luminous efficiency	LO	ST	HI
	65° 118lm/W	113lm/W	108lm/W *
	55° 117lm/W	112lm/W	107lm/W *
up	110lm/W	106lm/W	101lm/W *
electrical control	ON / OFF	▲ 9	
	DALI	▲ 8	
color temperature	3000K	● 3	
	4000K	● 4	
	on request: TUNABLE WHITE	● 9	
luminaire color	black 9005	● 01	
	white 9010	● 02	
	on request: RAL color palette	● 99	
reflector color	black matte	* 01	
	white matte	* 02	
	silver matte	* 04	
dark optics	dark optic 65°	■ 3	
	dark optic 55°	■ 4	
	blind cover	■ 9	

Photometric data: 4 ft, 4000K, CRI 90, 65°, white reflector

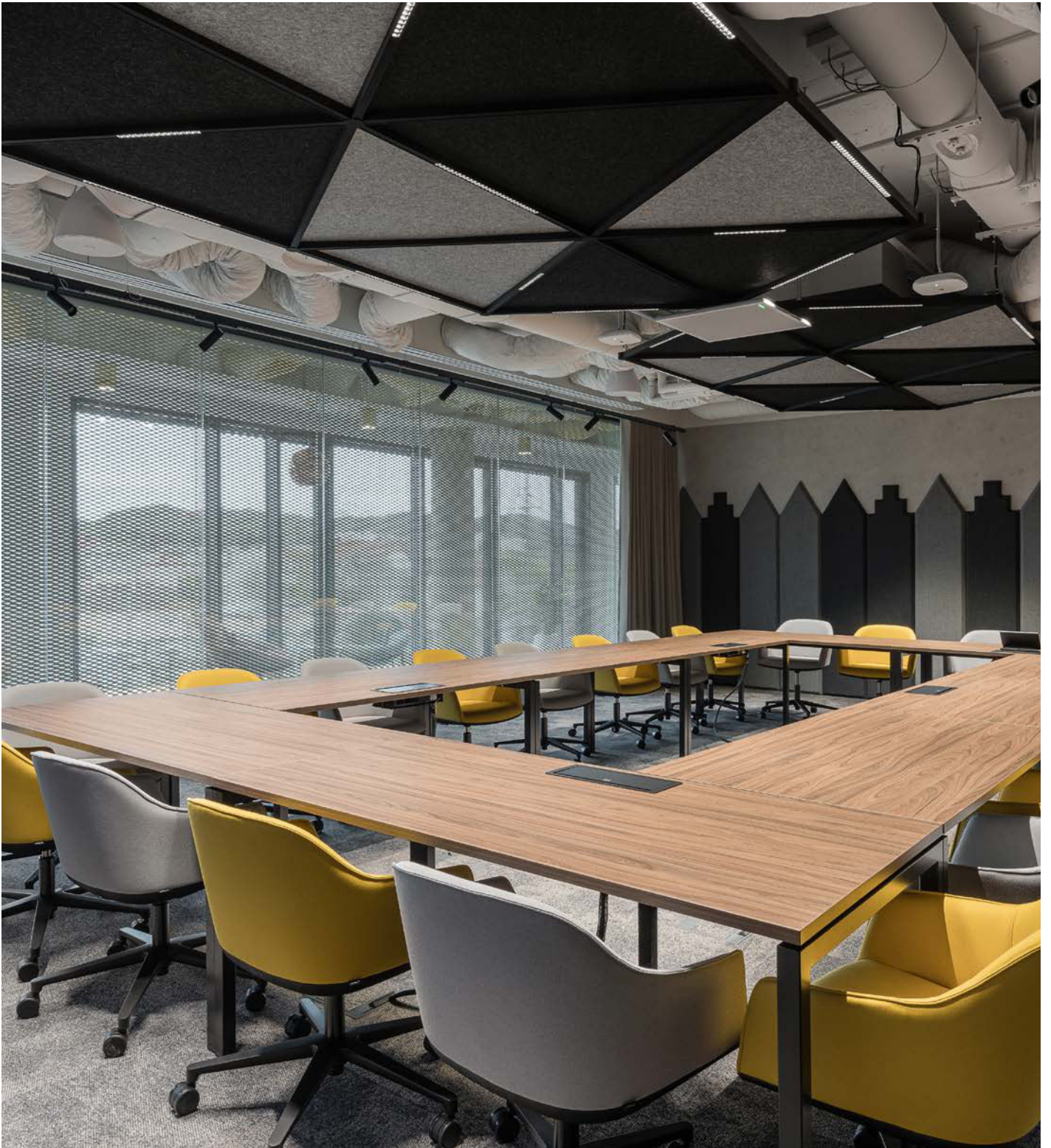

ERGO GDAŃSK TRZÓP ARCHITEKCI

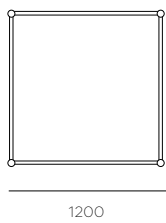
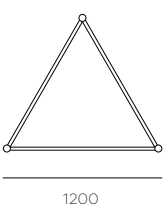

40
PET
BOTTLES



up to
1.44 m²
ACOUSTIC
SURFACE

Horizon X / Horizon Y

EN Horizon X and Horizon Y are innovative acoustic lamps that merge lighting and acoustics into a single design. These lamps utilize a unique approach by incorporating the Dot system, which is comprised of four sections of Line 28 for Horizon X and three sections for Horizon Y. The lamp's structure is adorned with PET panels positioned on the upper arms of each profile. These PET panels are available in different shapes and can be customized to match a variety of color schemes.

DE Horizon X und Horizon Y sind innovative Akustikleuchten, die Beleuchtung und Akustik in einem einzigen Design vereinen. Diese Lampen verwenden einen einzigartigen Ansatz, indem sie das Dot-System integrieren, das aus vier Abschnitten der Linie 28 für Horizon X und drei Abschnitten für Horizon Y besteht. Die Struktur der Lampe ist mit PET-Paneelen verziert, die an den oberen Armen jedes Profils angebracht sind. Diese PET-Paneele sind in verschiedenen Formen erhältlich und können an eine Vielzahl von Farbschemata angepasst werden.

Create my unique code!

Horizon X 2156 - 00 - ~ - ▲ - ● - ◆ - * - 2 - ◆

Horizon Y 2157 - 00 - ~ - ▲ - ● - ◆ - * - 2 - ◆

Example

Horizon X	standard power	4000K	dark optics 65° with black reflector	ARCHI felt color 1201 Cloud
↑	↑	↑	↑	↑
2156 - 00 - 2 - 8 - 4 - 01 - 20 - 2 - archi1201				
	↓	↓	↓	↓
one size	DALI	luminaire black 4009	pendant	

Quickinfo

	Horizon X	Horizon Y
luminaire size	1220×1220×h	1043×930×h
system power	4 × ±9.8W*	3 × ±9.8W*
luminous flux	±4468lm*	±3351lm*

Technical information

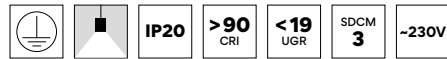

lighting power	low	~ 1	
	standard	~ 2	
	high	~ 3	
light distribution - down	120° opal		
	60° microprismatic		
	65° dark optics		
	55° dark optics		
luminous efficiency	LO	ST	HI
65°	118lm/W	113lm/W	108lm/W *
55°	117lm/W	112lm/W	107lm/W *
electrical control	ON / OFF		▲ 9
	DALI		▲ 8
color temperature	3000K		● 3
	4000K		● 4
	on request: TUNABLE WHITE		● 9
luminaire color	black 9005		◆ 01
	white 9010		◆ 02
	on request: RAL color palette		◆ 99
optics	opal		* 10
	microprismatic		* 11
	dark optics 65° (black reflector)		* 20
	dark optics 65° (white reflector)		* 21
	dark optics 65° (silver reflector)		* 22
	dark optics 55° (black reflector)		* 23
	dark optics 55° (white reflector)		* 24
	dark optics 55° (silver reflector)		* 25
fabric color	ARCHI felt ecoPET color palette archixxx - choose color from page 266		◆ archixxx

Photometric data: dark optics 65°, white reflector, 4000K

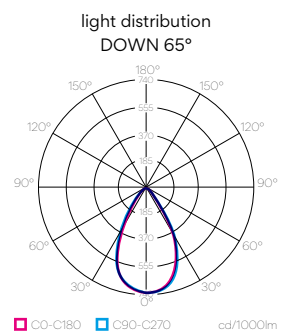
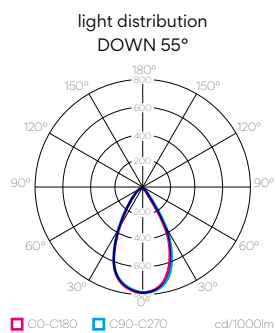
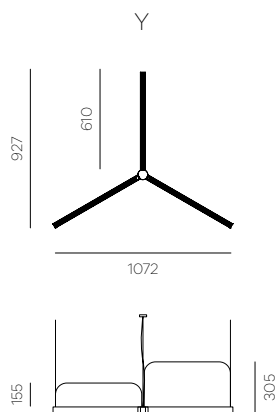
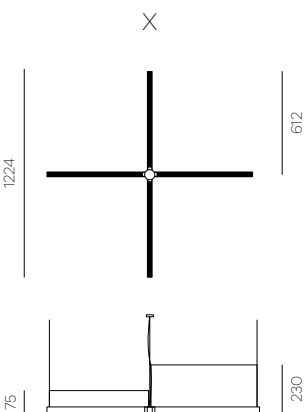
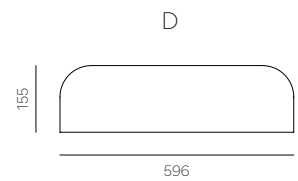
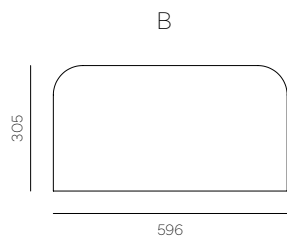
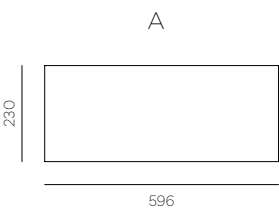

254
PET
BOTTLES

PET THICKNESS
24 mm

up to
4.80m²
ACOUSTIC
SURFACE



Easy Round

EN Easy Round acoustic lamp is a functional and versatile lighting solution designed specifically for office environments. Its design emphasizes simplicity and functionality while addressing both lighting and noise absorption needs. The lamp's construction comprises two PET panels, which contribute to its thickness and help reduce ambient noise in the office environment. By absorbing sound waves, the lamp assists in creating a quieter and more conducive workspace. The high-quality lighting provided by the Easy Round lamp is a significant feature. One notable aspect of the lamp's design is its flat horizontal structure. This design attribute allows the light to be distributed at a wide angle, which can effectively illuminate a larger area.

DE Die Easy Round Akustikleuchte ist eine funktionelle und vielseitige Beleuchtungslösung, die speziell für Büroumgebungen entwickelt wurde. Ihr Design betont Einfachheit und Funktionalität und erfüllt gleichzeitig die Anforderungen an Beleuchtung und Geräuschdämmung. Die Konstruktion der Lampe besteht aus zwei PET-Paneelen, die zu ihrer Dicke beitragen und helfen, den Umgebungslärm in der Büroumgebung zu reduzieren. Durch die Absorption von Schallwellen trägt die Lampe dazu bei, einen ruhigeren und angenehmeren Arbeitsplatz zu schaffen. Die hohe Lichtqualität der Easy Round Lampe ist ein wichtiges Merkmal. Ein bemerkenswerter Aspekt des Lampendesigns ist die flache horizontale Struktur. Dieses Designmerkmal ermöglicht es, das Licht in einem weiten Winkel zu verteilen, wodurch ein größerer Bereich effektiv beleuchtet werden kann.

Example

Easy Round standard power 4000K no frame ARCHI felt color 1201 Cloud

↑ ↑ ↑ ↑ ↑

2158 - 01 - 2 - 8 - 4 - 02 - 00 - 2 - archi1201

↓ ↓ ↓ ↓

size SA DALI luminaire white 9010 pendant

Quickinfo

	SA ■ 01 SB ■ 02	MA ■ 03 MB ■ 04	LA ■ 05 LB ■ 06	XLA ■ 07 XLB ■ 08
luminaire size	Ø1000	Ø1150	Ø1450	Ø1780
light source size	A Ø320×57 B Ø450×82	Ø320×57 Ø450×82	Ø320×57 Ø600×82	Ø320×57 Ø600×82
UGR	B <17	<17	<17	<17

Technical information

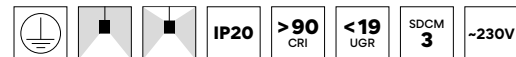

system power	A S / M / L / XL	↓10W ↓15W ↓20W	~ 1 ~ 2 ~ 3
	B S / M	30W (↑9W ↓21W)	
luminous flux	A S / M / L / XL	↓1200lm ↓1800lm ↓2400lm	
	B S / M	↑1000lm ↓2100lm	
light distribution - down	A S / M / L / XL	150°	
	B S / M / L / XL	95°	
luminous efficiency	A S / M / L / XL	120lm/W	
	B S / M	110lm/W	
	B L / XL	116lm/W	
electrical control		ON / OFF	▲ 9
		DALI	▲ 8
color temperature	A S / M / L / XL	3000K	● 3
		4000K	● 4
		6000K	● 6
	B S / M / L / XL	3000K	● 3
		4000K	● 4
luminaire color	A S / M / L / XL	white	● 02
	B S / M / L / XL	black white	● 01 ● 02
fabric color		ARCHI felt ecoPET color palette archixxx - choose color from page 266	◆ archixxx

Create my unique code!

2158 - ■ - ~ - ▲ - ● - ◆ - 00 - 2 - ◆

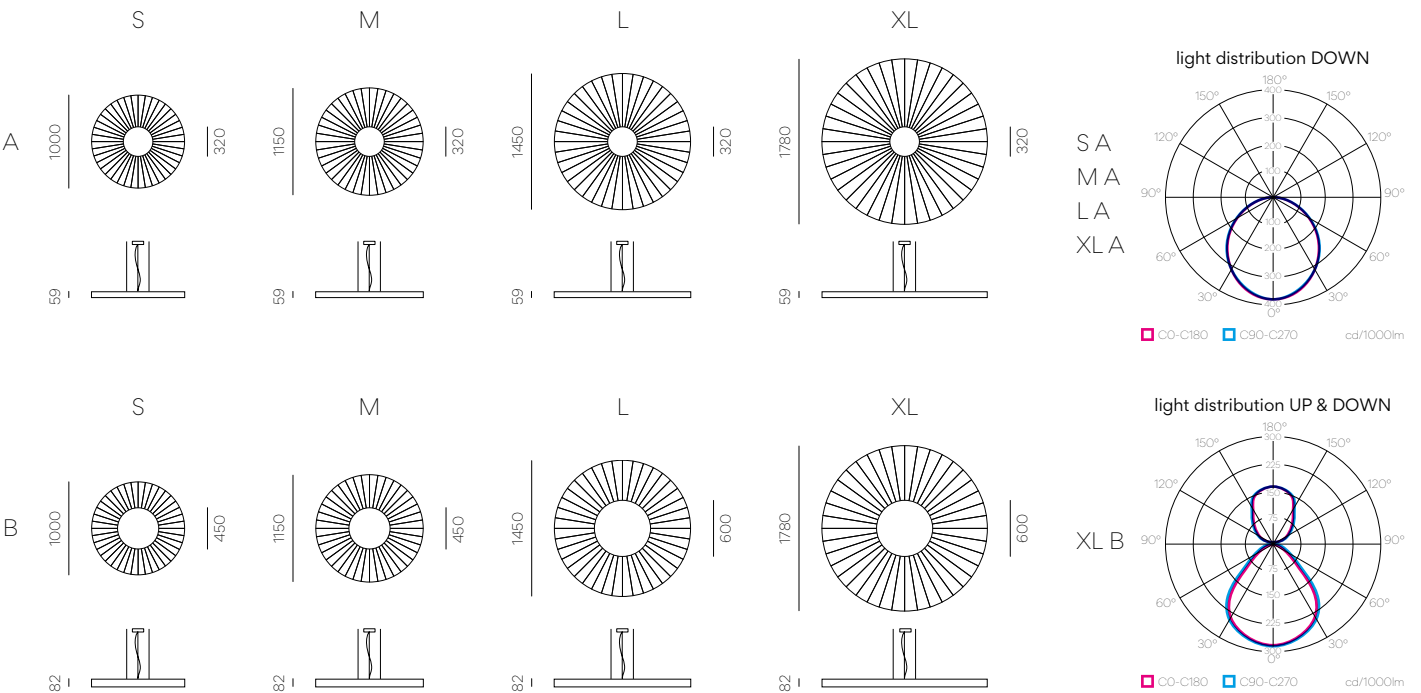

258
PET
BOTTLES

PET THICKNESS
24 mm

up to
4.88 m²
ACOUSTIC
SURFACE

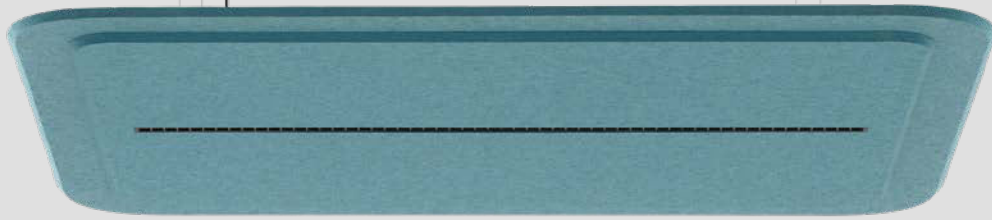

Easy Edge Line

EN The Acoustic Easy Edge Line lamp truly stands out with its combination of simplicity, outstanding acoustic qualities, and high-quality lighting. Its design showcases an appreciation for minimalism and functionality, making it an appealing option for various office settings. The use of double PET panels made from recycled PET bottles not only demonstrates a commitment to sustainability but also contributes to the lamp's exceptional acoustic properties. The availability of different sizes for the lamp is a thoughtful addition, allowing businesses to tailor the lighting solution to their specific office needs.

DE Acoustic Easy Edge Line zeichnet sich durch eine Kombination aus Schlichtheit, hervorragenden akustischen Eigenschaften und hochwertiger Beleuchtung aus. Ihr Design zeigt eine Wertschätzung für Minimalismus und Funktionalität, was sie zu einer ansprechenden Option für verschiedene Büroumgebungen macht. Die Verwendung von doppelten PET-Platten aus recycelten PET-Flaschen ist nicht nur ein Zeichen für Nachhaltigkeit, sondern trägt auch zu den außergewöhnlichen akustischen Eigenschaften der Leuchte bei. Die Verfügbarkeit verschiedener Größen für die Leuchte ist eine durchdachte Ergänzung, die es Unternehmen ermöglicht, die Beleuchtungslösung an ihre spezifischen Büroanforderungen anzupassen.

Create my unique code!

2159 - ■ - ~ - ▲ - ○ - ◆ - * - 2 - ◆

Example

Easy Edge Line	standard power	4000K	dark optics 65° with black reflector	ARCHI felt color 1201 Cloud
↑	↑	↑	↑	↑
2159	- 01	- 2	- 8	- 4
	- 02	- 20	- 2	- archi1201
	↓	↓	↓	↓
	size SA	DALI	luminaire white 9010	pendant

Quickinfo

Easy Edge Line	SA ■ 01 SB ■ 02	M ■ 03	L ■ 04	XL ■ 05
luminaire size	1150x1150x54	1150x1450x54	1150x1800x54	1150x2380x54
light source size	A 854x28x40 B 2 pcs 854x28x40	1134x28x40	1414x28x40	1694x28x40
system power	A ↓14.7W B ↓29.4W	↓19.6W	↓24.5W	↓29.4W
luminous flux	A ↓1675lm B ↓3350lm	↓2234lm	↓2792lm	↓3350lm

Technical information

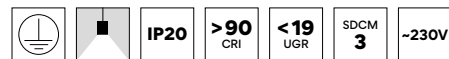

lighting power	low	~ 1		
	standard	~ 2		
	high	~ 3		
light distribution - down	120° opal			
	60° micropismatic			
	65° dark optics			
	55° dark optics			
luminous efficiency	LO	ST	HI	
	65°	118lm/W	113lm/W	108lm/W *
	55°	117lm/W	112lm/W	107lm/W *
electrical control	ON/OFF	▲ 9		
	DALI	▲ 8		
color temperature	3000K	● 3		
	4000K	● 4		
	on request: TUNABLE WHITE	● 9		
housing color	black 9005	◆ 01		
	white 9010	◆ 02		
	on request: RAL color palette	◆ 99		
optics	opal	* 10		
	micropismatic	* 11		
	dark optics 65° (black reflector)	* 20		
	dark optics 65° (white reflector)	* 21		
	dark optics 65° (silver reflector)	* 22		
	dark optics 55° (black reflector)	* 23		
	dark optics 55° (white reflector)	* 24		
dark optics 55° (silver reflector)	* 25			
fabric color	ARCHI felt ecoPET color palette archixx - choose color from page 266	◆ archixx		

* Photometric data: dark optics 65°, white

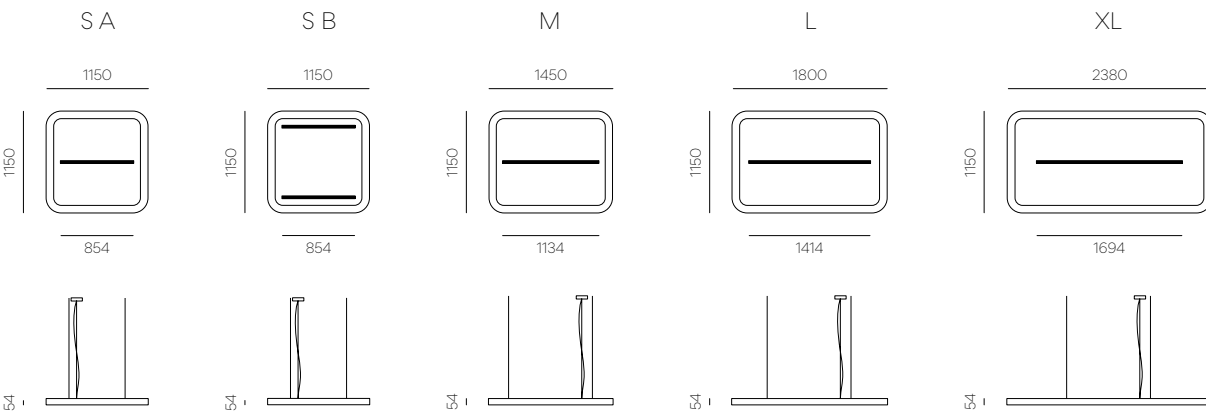

On request we can produce it in other sizes!

231
PET
BOTTLES

PET THICKNESS
24 mm

up to
4.37 m²
ACOUSTIC
SURFACE



Easy Edge Panel

EN The Acoustic Easy Edge Panel lamp truly stands out with its combination of simplicity, outstanding acoustic qualities, and high-quality lighting. Its design showcases an appreciation for minimalism and functionality, making it an appealing option for various office settings. The use of double PET panels made from recycled PET bottles not only demonstrates a commitment to sustainability but also contributes to the lamp's exceptional acoustic properties. The availability of different sizes for the lamp is a thoughtful addition, allowing businesses to tailor the lighting solution to their specific office needs.

DE Die Acoustic Easy Edge Panel-Lampe zeichnet sich durch eine Kombination aus Einfachheit, hervorragenden akustischen Eigenschaften und hochwertiger Beleuchtung aus. Ihr Design zeigt eine Wertschätzung für Minimalismus und Funktionalität, was sie zu einer ansprechenden Option für verschiedene Büroumgebungen macht. Die Verwendung von doppelten PET-Paneelen aus recycelten PET-Flaschen zeugt nicht nur von einem Engagement für Nachhaltigkeit, sondern trägt auch zu den außergewöhnlichen akustischen Eigenschaften der Leuchte bei. Die Verfügbarkeit verschiedener Größen für die Leuchte ist eine durchdachte Ergänzung, die es Unternehmen ermöglicht, die Beleuchtungslösung an ihre spezifischen Büroanforderungen anzupassen.

Create my unique code!

2160 - ■ - ~ - ▲ - ● - 02 - 00 - 2 - ◆

Example

Easy Edge Panel	standard power	4000K	no frame	ARCHI felt color 1201 Cloud
↑	↑	↑	↑	↑
2160	- 01	- 2	- 8	- 4
	- 02	- 00	- 2	- archi1201
	↓	↓	↓	↓
	size SA	DALI	luminaire white 9010	pendant

Quickinfo

Easy Edge Panel	SA ■ 01 SB ■ 02	M ■ 03	L ■ 04	XL ■ 05
luminaire size	A 1150x1150x65 B 1150x1150x54	1150x1450x65	1150x1800x65	1150x2380x65
light source size	A 320x320x57 B 600x600x31	2 pcs 320x320x57	2 pcs 320x320x57	3 pcs 320x320x57
UGR	B <19			

Technical information

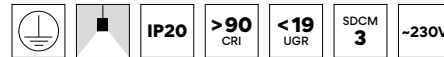

system power	S	M / L	XL
	A ↓10W ~ 1 ↓15W ~ 2 ↓20W ~ 3	↓20W ~ 1 ↓35W ~ 2 ↓40W ~ 3	↓30W ~ 1 ↓45W ~ 2 ↓60W ~ 3
	B 40W ~ 2		
luminous flux	S	M / L	XL
	A ↓1200lm ↓1800lm ↓2400lm	↓2400lm ↓3600lm ↓4800lm	↓3600lm ↓4400lm ↓7200lm
	B ↓4500lm		
light distribution - down	A S / M / L / XL	150°	
	B S	90°	
luminous efficiency	A S / M / L / XL	120lm/W	
	B S	110lm/W	
electrical control		ON/OFF	▲ 9
		DALI	▲ 8
color temperature	A S / M / L / XL	3000K	● 3
		4000K	● 4
		6000K	● 6
	B S	3000K	● 3
		4000K	● 4
luminaire color		white	◆ 02
fabric color		ARCHI felt ecoPET color palette archixx - choose color from page 266	◆ archixxx



light distribution DOWN

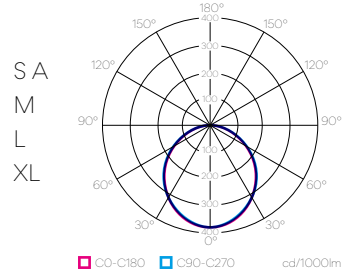

light distribution DOWN

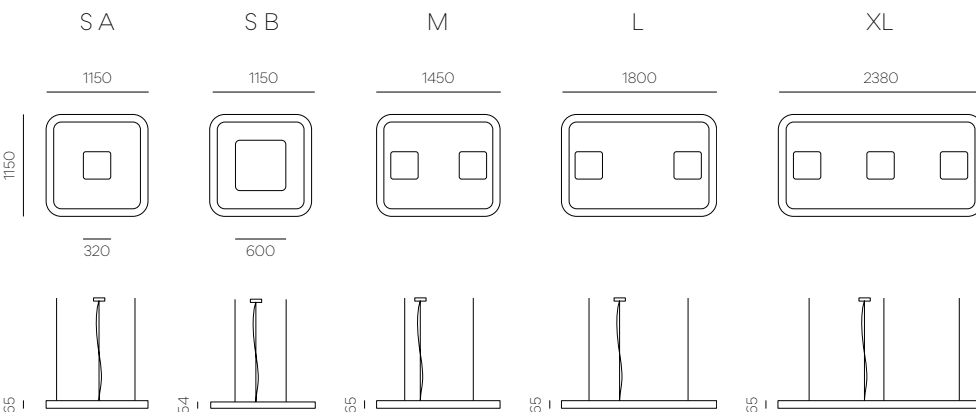
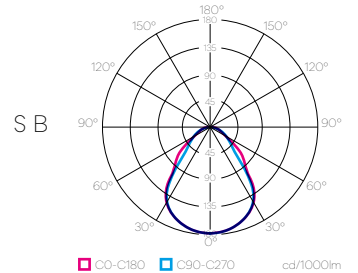

95
PET
BOTTLES↓
PET THICKNESS
12 mm
↑up to
3.60 m²
ACOUSTIC
SURFACE

Screen Glow



EN Screen Glow is a hanging office divider equipped with a linear luminaire in a mini version. It is designed to not only absorb office noise but also illuminate and casting a gentle glow across the office floor. Screen Glow can be easily hung in various places throughout your workspace, making it a flexible solution to adapt to changing office layouts. Make Screen Glow uniquely yours! Screen Glow can be personalized with various designs or motivational notes using a plotter machine, adding a touch of inspiration and creativity to your workspace.

Screen Glow serves a dual purpose by providing effective acoustic separation between workstations while creating a soothing ambiance through its integrated linear luminaire.

DE Screen Glow ist ein hängender Raumtrenner, der mit einer linearen Leuchte ausgestattet ist. Er ist so konzipiert, dass er nicht nur die Geräusche im Büro absorbiert, sondern auch ein sanftes Licht auf den Büroboden wirft. Screen Glow kann leicht an verschiedenen Stellen in Ihrem Arbeitsbereich aufgehängt werden und ist somit eine flexible Lösung, die sich an wechselnde Büroaufteilungen anpassen lässt. Kreieren Sie selbst ein Einzigartiges Produkt! Screen Glow kann mit Hilfe eines Plotters mit verschiedenen Motiven oder motivierenden Sprüche personalisiert werden, was Ihrem Arbeitsplatz einen Hauch von Inspiration und Kreativität verleiht.

Screen Glow erfüllt einen doppelten Zweck, indem es für eine effektive akustische Trennung zwischen den.

Example

Screen Glow	standard power	3000 K	opal	ARCHI felt color 1201 Cloud
↑	↑	↑	↑	↑
2154	- 01	- 2	- 8	- 3
		- 01	- 10	- 2
				- archi1201
	↓	↓	↓	↓
	pattern 01	DALI	luminaire black 9005	pendant down

Quickinfo

	Screen Glow	■ 01-99	see page 235
luminaire size	900×2065×28		
system power	↑14.7W ↓14.7W		
luminous flux	↑1406lm ↓1406lm		

Technical information



lighting power	low	~ 1	
	standard	~ 2	
	high	~ 3	
mounting type	pendant down	☾ 2	
	pendant up & down	☾ 3	
	pendant up	☾ 9	
light distribution - up	120° opal		
light distribution - down	120° opal		
luminous efficiency	LO	ST	HI
	up	99lm/W	95lm/W
down	99lm/W	95lm/W	91lm/W *
electrical control	ON/OFF	▲ 9	
	DALI	▲ 8	
color temperature	3000K	● 3	
	4000K	● 4	
	on request: TUNABLE WHITE	● 9	
luminaire color	black 9005	◆ 01	
	white 9010	◆ 02	
	on request: RAL color palette	◆ 99	
fabric color	ARCHI felt ecoPET color palette	◆ archixxx	
	archixxx - choose color from page 266		

Photometric data: opal 3 ft, 4000K, CRI 90

Create my unique code!

2154 - ■ - ~ - ▲ - ● - ◆ - 10 - ☾ - ◆

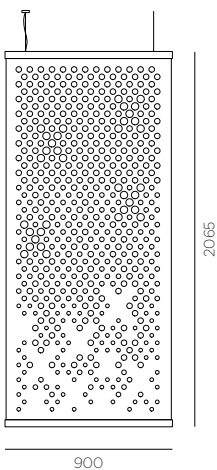

For available patterns,
please refer to page 235

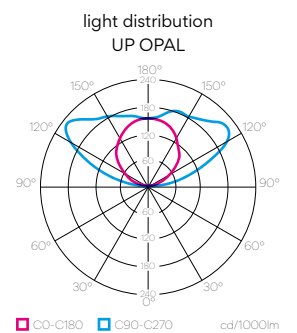
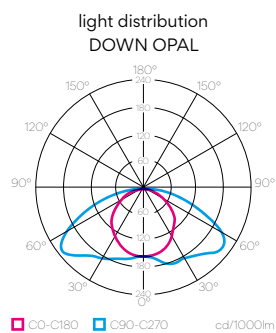

Acoustic felt

EN The Acoustic felt lighting fittings line was designed with high-quality natural felt – 100% Merino Wool. Organic wool felt is one of the oldest textile materials in the world; it combines excellent acoustic and thermal insulation properties and is easy to use and maintain. We obtain felts available in our offer only from producers with a cruelty-free certificate.

DE Die Akustikfilz-Leuchtenlinie wurde aus hochwertigem Naturfilz – 100% Merinowolle – entworfen. Bio-Wollfilz ist eines der ältesten Textilmaterialien der Welt; Es kombiniert hervorragende akustische und thermische Isoliereigenschaften und ist einfach zu verwenden und zu warten. Die in unserem Angebot verfügbaren Filze beziehen wir nur von Produzenten mit Tierversuchsfreiheit-Zertifikat.



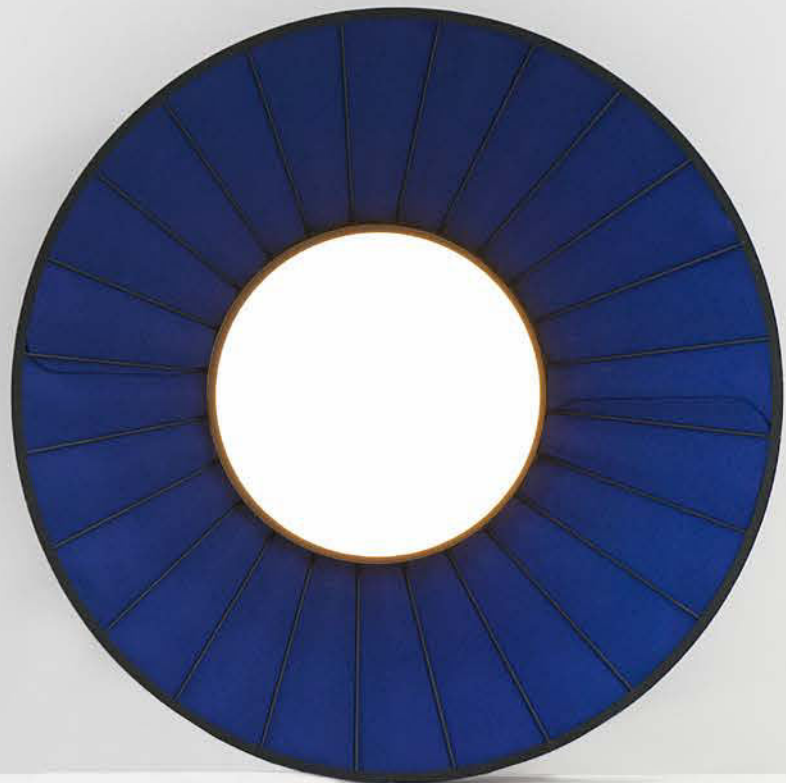



Cone



EN Thanks to the bold combination of an industrial shade and acoustic fabric, an unusual model of office luminaire was created. The top quality design, noise attenuation and, above all, excellent technical parameters – all these are the features of a luminaire ideal for work. The product offers the possibility of personalizing the color of the fabric based on the M&K Filze color palette.

The Cone lamp has been awarded with the global sign of exceptional design – iF DESIGN AWARD 2022. It was also nominated for the German Design Award 2021 in the Excellent Product Design category.

DE Dank der kühnen Kombination eines industriellen Lampenschirms mit einem akustischen Stoff wurde ein ungewöhnliches Modell einer Büroleuchte geschaffen. Design höchster Qualität, Geräuscherdrückung und vor allem hervorragende technische Parameter – all dies sind die Merkmale der Leuchte, die sich ideal für die Arbeit eignet. Die Farbe des Stoffes kann, basierend auf der Farbpalette der M&K, personalisiert werden.

Die Cone wurde mit dem globalen Zeichen für außergewöhnliches Design ausgezeichnet – dem iF DESIGN AWARD 2022. Zudem wurde die Leuchte für den German Design Award 2021 in der Kategorie Excellent Product Design nominiert.

Example

Cone	standard power	4000K	frame black 9005	Flexica wool felt color 2318
↑	↑	↑	↑	↑
2100 - 03	- 2	- 8	- 4 - 01	- 01 - 3 - FW2318
↓	↓	↓	↓	↓
size L	DALI	luminaire black	pendant up & down	

Quickinfo

	Cone L ■ 03	Cone XL ■ 04
luminaire size	Ø 1070 × 150	Ø 1430 × 200
light source size	Ø 450 × 82	Ø 600 × 82
system power	30W (↑9W ↓21W)	48W (↑14W ↓34W)
luminous flux	↑1000lm ↓2100lm	↑1750lm ↓3500lm
UGR	<18	<17

Technical information

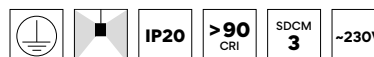

light distribution - down	110°	90°
luminous efficiency	80lm/W	110lm/W
electrical control	ON / OFF	▲ 9
	DALI	▲ 8
color temperature	3000K	● 3
	4000K	● 4
luminaire color	black	◆ 01
	white	◆ 02
frame color	black 9005	* 01
	white 9010	* 02
	on request: RAL color palette	* 99
fabric color	Flexica wool felt color palette FWxxxx – choose color from page 267	◆ FWxxxx
	on request: Flexica felt color palette FFxxxx – choose color from page 267	◆ FFxxxx

Create my unique code!

2100 - ■ - 2 - ▲ - ● - ◆ - * - 3 - ◆

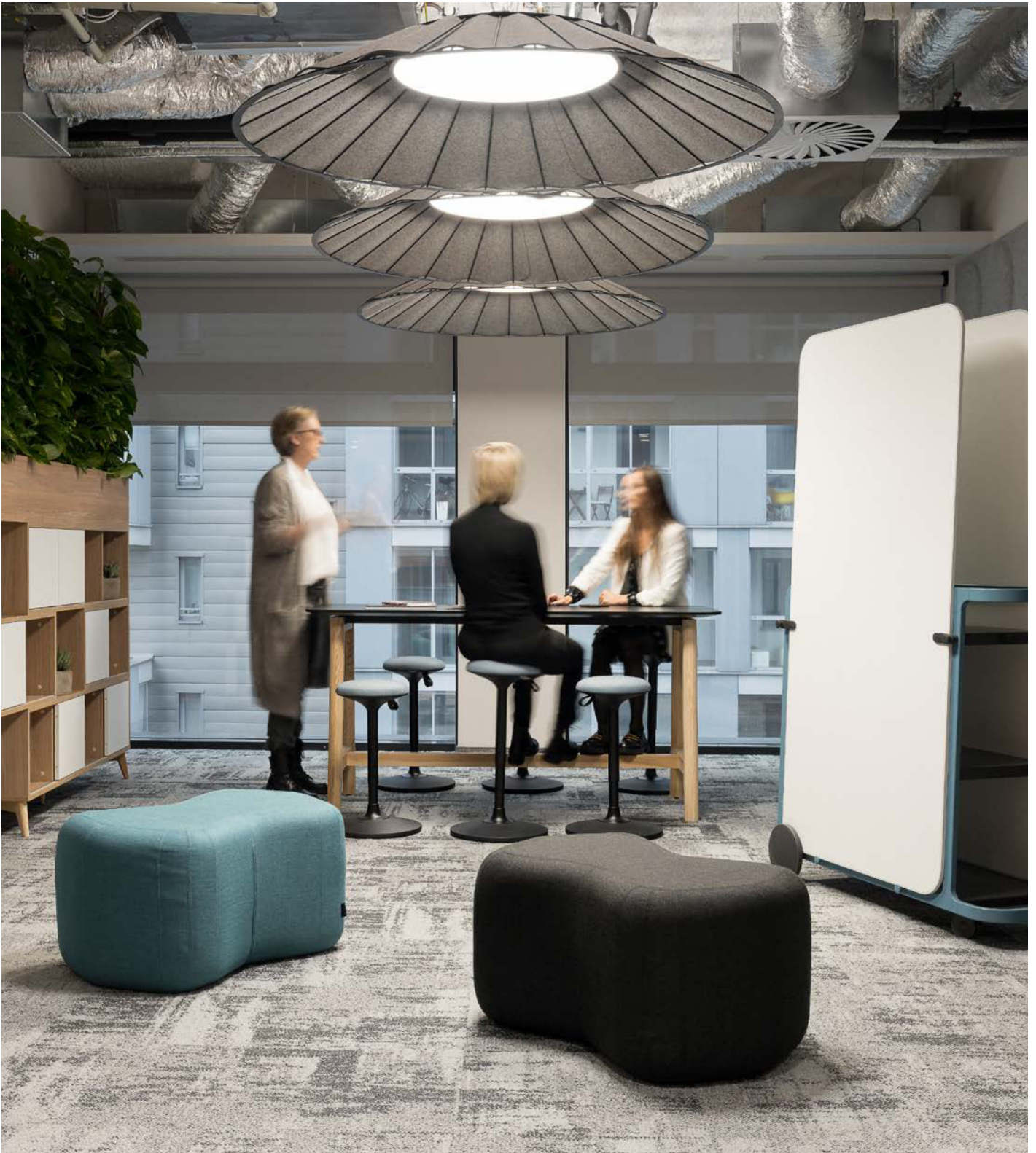

EOS POLAND TRZOP ARCHITEKCI

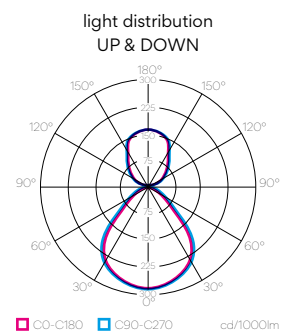
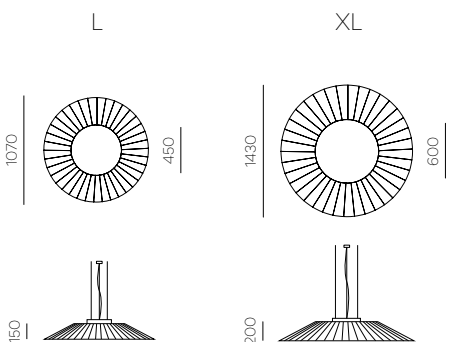



Cone Square

EN Acoustic Cone Square is an industrial office lamp made of sound-absorbing felt material with a unique and modern design focusing on workplace functionality and acoustic performance. The lampshade is made of a 5mm thick, high-quality felt material designed to absorb sound waves and reduce ambient noise in the office space. Acoustic Cone Square lamp is ideal for busy office environments or other areas where noise reduction is essential. The lamp frame is made of a sturdy powder-coated metal providing a stable foundation for the lampshade. The overall aesthetic of the Acoustic Cone Square lamp is sleek and minimalist, felt material adds an extra layer of texture and depth to the design.

DE Acoustic Cone Square ist eine industrielle Büroleuchte aus schallabsorbierendem Filzmaterial mit einem einzigartigen und modernen Design, das sich auf die Funktionalität des Arbeitsplatzes und die akustische Leistung konzentriert. Der Lampenschirm besteht aus einem 5 mm dicken, hochwertigen Filzmaterial, das Schallwellen absorbiert und den Umgebungslärm im Büro reduziert. Die Acoustic Cone Square Lampe ist ideal für belebte Büroumgebungen oder andere Bereiche, in denen Geräuschreduzierung wichtig ist. Das Gestell der Leuchte besteht aus robustem, pulverbeschichtetem Metall und bietet eine stabile Basis für den Lampenschirm. Die Gesamtästhetik der Acoustic Cone Square Lampe ist schlicht und minimalistisch, das Filzmaterial verleiht dem Design eine zusätzliche Schicht aus Textur und Tiefe.

Example

Cone Square	standard power	4000K	frame white	Flexica wool felt color 2318
↑	↑	↑	↑	↑
2161 - 01	- 2	- 8	- 4 - 02	- 02 - 2 - FW2318
↓	↓	↓	↓	↓
size L	DALI	luminaire white 9010	pendant	

Quickinfo

	Cone Square L ■ 01	Cone Square XL ■ 02
luminaire size	1070×1070×153	1400×1400×208
light source size	450×450×31	600×600×31
system power	↓28W	↓40W
luminous flux	↓2000lm	↓4500lm
UGR		<19
light distribution – down	110°	90°
luminous efficiency	80lm/W	110lm/W
electrical control	ON/OFF ▲ 9	ON/OFF ▲ 9 DALI ▲ 8
luminaire color	white ● 02	black ● 01 white ● 02

Technical information

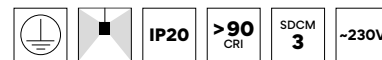

color temperature	3000K ● 3 4000K ● 4
frame color	black 9005 * 01 white 9010 * 02 on request: RAL color palette * 99
fabric color	Flexica wool felt color palette ◆ FWxxxx – choose color from page 267 on request: Flexica felt color palette ◆ FFxxxx – choose color from page 267

Create my unique code!

2161 - ■ - 2 - ▲ - ○ - ● - * - 2 - ◆



L

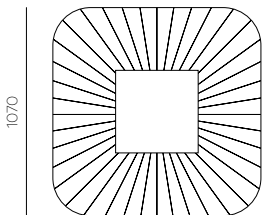

153

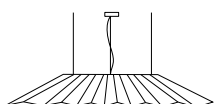

XL

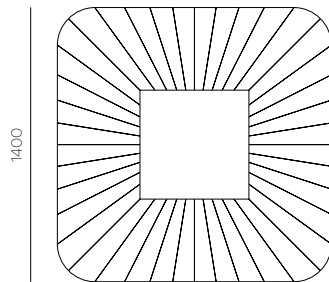

208

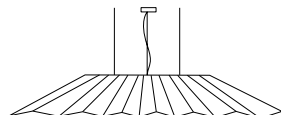

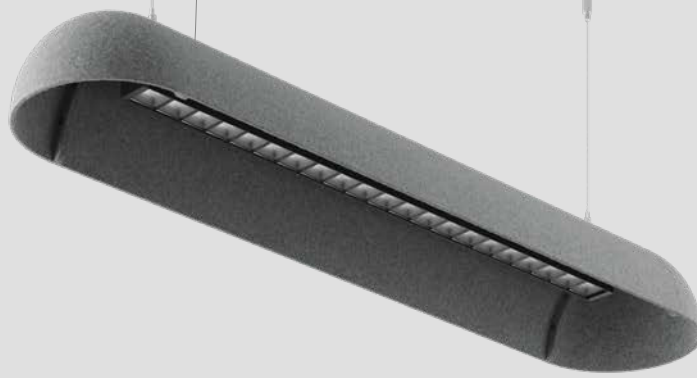

Team



reddot winner 2021
best of the best

EN A modular lamp made of three different components that can be combined in different ways. Thanks to the domed shade and the pressed fabric, the lamp absorbs some of the ambient sound. These features make it perfect for office environments, such as open-plan offices. Thanks to its excellent design, it creates a warm atmosphere in any interior. Recycled plastic bottles have been used to make the shade. The luminaire is available in two lighting options – for ambient lighting and for work. The color of the shade can be customized.

The lamp was awarded the Red Dot Award: Best of the Best 2021, designed by Kabo & Pydo – Design Studio.

DE Modullampe mit drei verschiedenen Elementen, die beliebig kombiniert werden können. Die Kuppelform des Lampenschirms und das gepresste Material sorgen dafür, dass die Lampe einen Teil der Umgebungsgeräusche absorbiert. Deshalb eignet sich das Modell perfekt für Büroarbeitsplätze, wie etwa in Open Space-Büros. Dank des ausgezeichneten Designs bringt sie eine warme Stimmung in den Raum. Bei der Herstellung des Lampenschirms wurden recycelte Plastikflaschen verarbeitet. Die Lampe ist in zwei Beleuchtungsvarianten erhältlich – als Deko-Leuchte und zur Arbeit. Möglichkeit zur Personalisierung der Farbe des Lampenschirms.

Die Lampe wurde mit der Auszeichnung Red Dot: Best of the Best 2021 ausgezeichnet, Entw. Kabo & Pydo – Design Studio.

Create my unique code!

2142 - ■ - 2 - ▲ - ● - ◆ - * - 2 - ◆

Example

Team	standard power	4000K	dark optics 80° with black reflector	Antrazit
↑	↑	↑	↑	↑
2142	- 01	- 2	- 8	- 4
	↓	↓	↓	↓
	size M	DALI	luminaire black 9005	pendant

Quickinfo

	Team M Team L	■ 01 ■ 02	Team XL Team XXL	■ 03 ■ 04
luminaire size	M 1150×250×125 L 2050×250×125		XL 2950×250×125 XXL 3850×250×125	
light source size	↓light		system power standard	luminous flux 4000K, opal
M	856 mm	■ 01	3 ft	↓14.7W ↓1406lm
L	1829 mm	■ 02	6 ft + blind covers	↓29.4W ↓2811lm
XL	2757 mm	■ 03	9 ft + blind covers	↓44.1W ↓4217lm
XXL	3657 mm	■ 04	13 ft	↓58.8W ↓5622lm
luminous efficiency	↓117lm			

Technical information

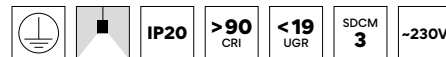

light distribution - down	120° opal 60° microprismatic 80° / 50° / 35° dark optic
electrical control	ON / OFF ▲ 9 DALI ▲ 8
color temperature	3000K ● 3 4000K ● 4
luminaire color	black 9005 ● 01 white 9003 ● 02 on request: RAL color palette ● 99
optics	opal * 10 microprismatic * 11 dark optics 80° (black reflector) * 40 dark optics 80° (white reflector) * 41 dark optics 80° (silver reflector) * 42 dark optics 50° (black reflector) * 43 dark optics 50° (white reflector) * 44 dark optics 50° (silver reflector) * 45 dark optics 35° (black reflector) * 46 dark optics 35° (white reflector) * 47 dark optics 35° (silver reflector) * 48
fabric color	Antrazit ◆ TAN Light Grey ◆ TLG Blue ◆ TBL Green ◆ TGR Coral ◆ TCO



EOS POLAND TRZOP ARCHITEKCI

Available colors

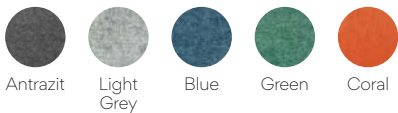

* Original product colors may vary from those illustrated.

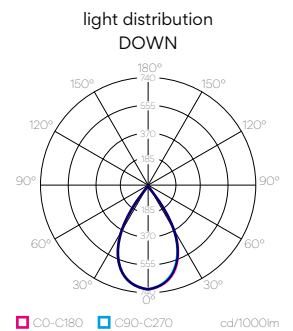
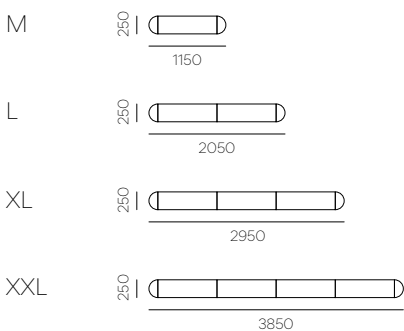



Shade

EN Acoustic lamp with an extraordinary shape. The modern wire processing techniques allowed us to achieve the unique industrial design of the lampshade. Woven with acoustic fabric, its new features include a warmer look and sound absorption. The color of the fabric is fully customisable, so you can select the one that complements your interior design. With the top-quality lighting components, the luminaire is an excellent choice for the office, especially for open-plan spaces.

DE Akustiklampe mit außergewöhnlicher Form. Dank moderner Drahtverarbeitungstechniken konnte eine einzigartige industrielle Form des Lampenschirms gestaltet werden. Der geflochtene Akustikstoff sorgt nicht nur für einen wärmeren Look, sondern auch für die Schallabsorption. Die Farbe des Stoffes ist vollständig personalisiert. Einfach entsprechend Ihrer Raumgestaltungspläne auswählen. Die Leuchte eignet sich dank der hochwertigen Beleuchtungskomponenten ideal für Büros, insbesondere für Open Space-Flächen.

Example

Shade	standard power	4000K	frame black 9005	Flexica wool felt color 2318
↑	↑	↑	↑	↑
2101	- 02	- 2	- 8	- 4
				- 01
				- 01
				- 3
				- FW2318
	↓	↓	↓	↓
	size LA	DALI	luminaire black	pendant up & down

Quickinfo

	Shade M ■ 01	Shade LA ■ 02	Shade LB ■ 03
luminaire size	Ø 410×220	Ø 805×430	Ø 805×430
light source size	Ø 140×162	Ø 450×82	Ø 320×57
system power	↓15W ~ 2 ↓20W ~ 3	30W (↑9W ↓21W)	↓10W ~ 1 ↓15W ~ 2 ↓20W ~ 3
luminous flux	↓1077lm ↓1508lm	↑1000lm ↓2100lm	↓1200lm ↓1800lm ↓2400lm
luminous efficiency	74lm/W		
mounting type	pendant ☾ 2	pendant ☾ 3 up & down	pendant ☾ 2
UGR	<19	<18	-
lighting power	standard		
light distribution - up	-	100°	-
light distribution - down	40°	95°	150°
luminous efficiency	90lm/W	110lm/W	110lm/W
color temperature	3000K ● 3 4000K ● 4	3000K ● 3 4000K ● 4	3000K ● 3 4000K ● 4 6000K ● 6

Technical information



electrical control	ON/OFF	▲ 9
	DALI	▲ 8
luminaire color	black	● 01
	white	● 02
frame color	black 9005 (01/02)	* 01
	white 9010	* 02
	on request: RAL color palette	* 99
fabric color	Flexica wool felt color palette FWxxxx - choose color from page 267	◆ FWxxxx
	on request: Flexica felt color palette FFxxxx - choose color from page 267	◆ FFxxxx

Create my unique code!

2101 - ■ - ~ - ▲ - ○ - ● - * - ☾ - ◆



ING KATOWICE MAŁECCY BIURO PROJEKTOWE

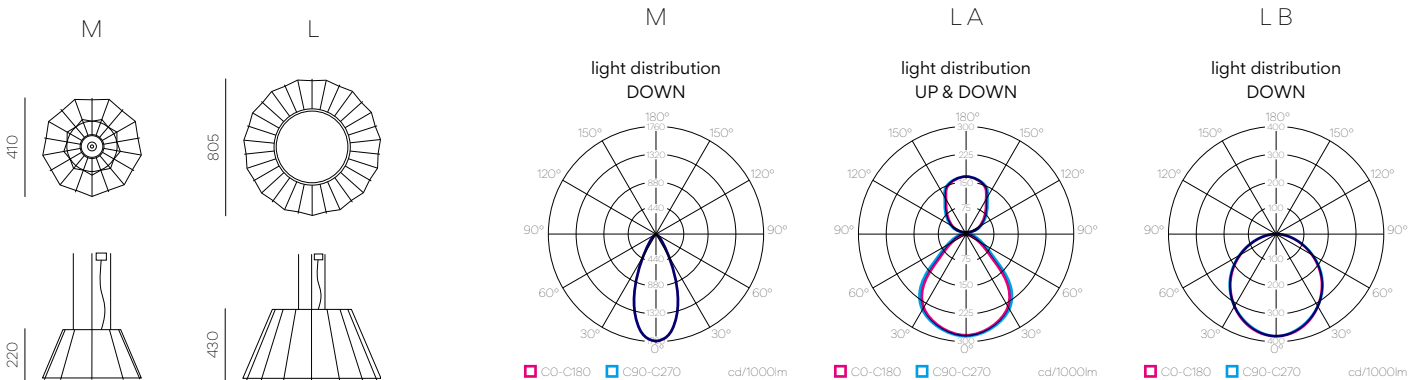

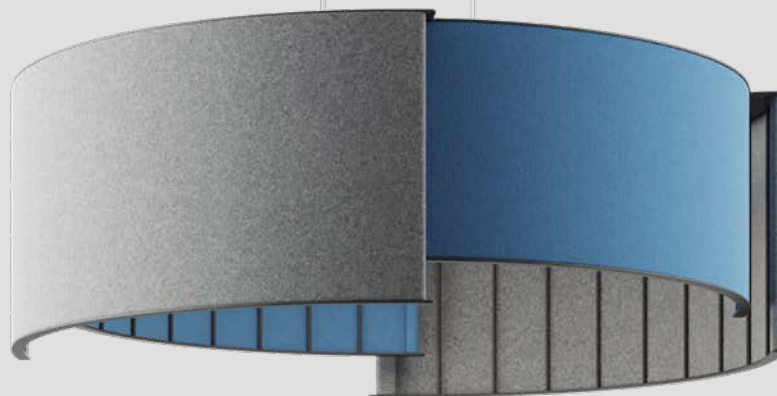

Quadro

EN A lamp consisting of independent four acoustic quadrants with an industrial-style frame. Its color and frame are fully customizable – you can choose from our color palette to match your design. Made of soft materials, it absorbs sounds that reach its surface. With its top-quality lighting components, it is perfect for offices, especially the open-plan type.

DE Eine Lampe aus vier unabhängigen Akustikvierteln mit industriellem Rahmen. Unbegrenzte Möglichkeiten zur Personalisierung der Farbe des Stoffs und Rahmen – je nach Projekt kann aus unserer Farbpalette gewählt werden. Dank der verwendeten weichen Materialien absorbiert das Modell die Geräusche, die den Lampenschirm erreichen. Aufgrund der hochwertigen Beleuchtungskomponenten eignet sich die Lampe ideal für Büroräume, insbesondere für Open Space-Flächen.

Example

Quadro standard power 4000K frame black 9005 Flexica wool felt color 2318

↑ ↑ ↑ ↑ ↑

2102 - 02 - 2 - 8 - 4 - 01 - 01 - 3 - FW2318

↓ ↓ ↓ ↓

size L DALI luminaire black pendant up & down

Quickinfo

	Quadro M ■ 01	Quadro L ■ 02
luminaire size	710×630×300	910×830×300
light source size	Ø 450×82	Ø 600×82
system power	30W (↑9W ↓21W)	48W (↑14W ↓34W)
luminous flux	↑1000lm ↓2100lm	↑1750lm ↓3500lm
UGR	<18	<17

Technical information

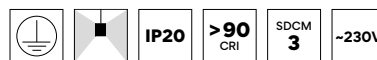

light distribution - up	100°
light distribution - down	95°
luminous efficiency	110lm/W
electrical control	ON / OFF ▲ 9 DALI ▲ 8
color temperature	3000K ● 3 4000K ● 4
luminaire color	black ● 01 white ● 02
frame color	black 9005 * 01 white 9010 * 02 on request: RAL color palette * 99
fabric color	Flexica wool felt color palette ◆ FWxxxx – choose color from page 267 on request: Flexica felt color palette ◆ FFxxxx – choose color from page 267

Create my unique code!

2102 - ■ - 2 - ▲ - ● - ◆ - * - 3 - ◆

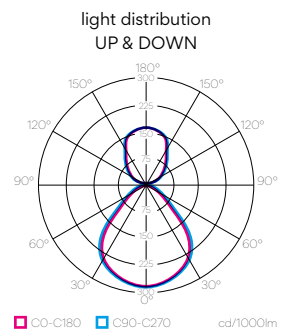
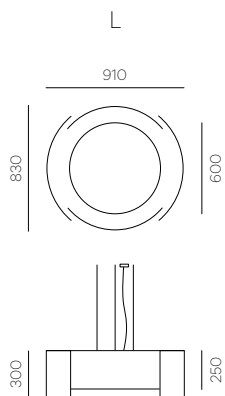
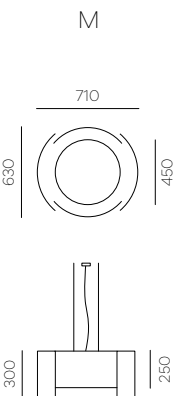

Bloom Collection





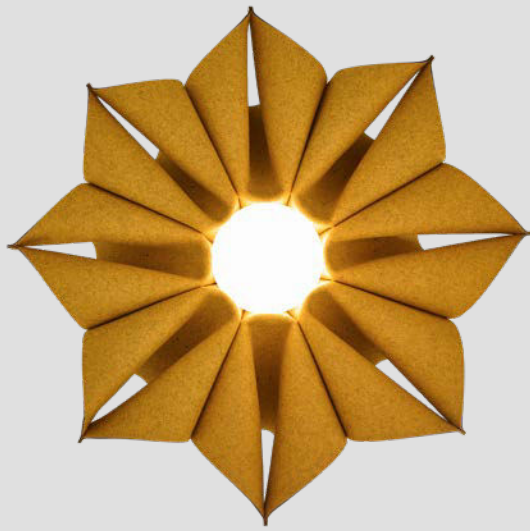

Ivy



EN Ivy is a felt-made sculptural lighting fixture, functioning as a luminaire, a sound-absorbing element, and a piece of art within the office. The Ivy Bloom design follows trends in the world of lighting and modern office architecture, where more and more functionalities are combined into one solution: give professional light, absorb noise, and bring more character into your office. The result is an interior's more uniform and integrated look and feels. The Bloom Collection was designed in cooperation with Anna Spakowska.

DE Ivy ist eine aus Filz gefertigte skulpturale Leuchte, die als Beleuchtung, schallabsorbierendes Element und Kunstwerk im Büro fungiert. Das Design von Ivy Bloom folgt Trends in der Welt der Beleuchtung und der modernen Büroarchitektur, wo immer mehr Funktionalitäten in einer Lösung kombiniert werden: professionelles Licht spenden, Lärm dämpfen und Ihrem Büro mehr Charakter verleihen. Das Ergebnis ist ein einheitlicherer und integrierterer Look und Haptik eines Interieurs. Die Bloom Collection wurde in Zusammenarbeit mit Anna Spakowska entworfen.

Example

Ivy
↑
2126 - 01 - 2 - 8 - 4 - 01 - 01 - 2 - FW2318

standard power
↑
4000K
↑
reflector black
↑
Flexxica wool felt color 2318
↑

↓
size M
↓
DALI
↓
luminaire black
↓
pendant

Quickinfo

	Ivy M Ivy L	■ 01 ■ 02	Ivy XL	■ 03
luminaire size	M Ø 800×350 L Ø 1000×420		XL Ø 1200×450	
light source size	Ø 140		Ø 300	
system power	↓15W standard ↓23W high		↓8W	-
luminous flux	↓1077lm / ↓1508lm		↓1050lm	
UGR	<19		-	
light distribution - down	40°		150°	

Technical information



luminous efficiency	74lm/W	
electrical control	ON/OFF	▲ 9
	DALI (size M/L)	▲ 8
color temperature	3000K	● 3
	4000K	● 4
luminaire color	black (size M/L)	◆ 01
	white (size M/L)	◆ 02
reflector color	black 9005 (size M/L)	* 01
	white 9010 (size M/L)	* 02
	silver	* 04
	gold	* 05
fabric color	Flexxica wool felt color palette FWxxxx - choose color from page 267	◆ FWxxxx

Create my unique code!

2126 - ■ - 2 - ▲ - ● - ◆ - * - 2 - ◆

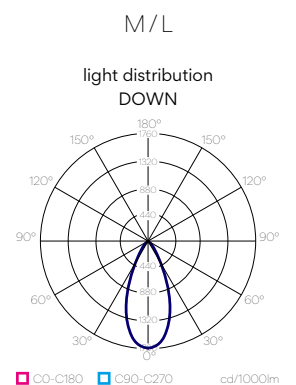
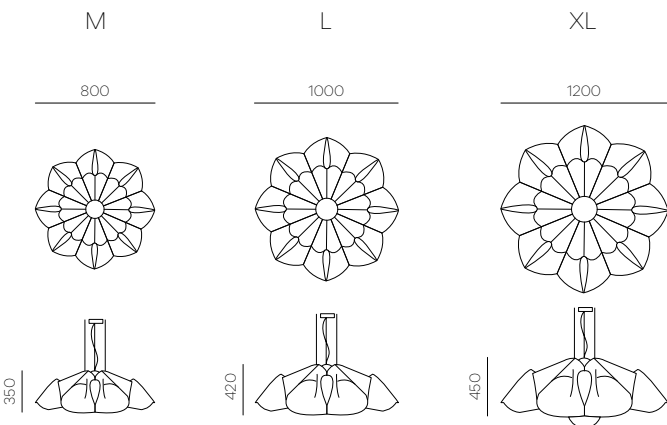



Lily

EN Light and design in perfect harmony that's the essence of the Bloom Lily lighting fixture. This luminaire is made of felt, stands out with its unique appearance, gives professional light, absorbs noise, and brings more character into your office. If several lights of different colors and sizes are mounted side by side as a cloud, this creates an exciting design of the ceiling office interior. The Bloom Collection was designed in cooperation with Anna Spakowska.

DE Licht und Design in perfekter Harmonie, das ist die Essenz der Leuchte Bloom Lily. Diese Leuchte aus Filz besticht durch ihr einzigartiges Erscheinungsbild, spendet professionelles Licht, dämmt Geräusche und bringt mehr Charakter in Ihr Büro. Werden mehrere Leuchten in unterschiedlichen Farben und Größen als Wolke nebeneinander montiert, entsteht eine spannende Gestaltung des Deckenbüros. Die Bloom Collection wurde in Zusammenarbeit mit Anna Spakowska entworfen.

Example

Lily	standard power	4000K	reflector black	Flexica wool felt color 2318
↑	↑	↑	↑	↑
2127	- 01	- 2	- 8	- 4
				- 01
				- 01
				- 2
				- FW2318
	↓	↓	↓	↓
	size M	DALI	luminaire black	pendant

Quickinfo

	Lily M	■ 01	Lily L	■ 02
luminaire size	600×630		900×950	
light source size	Ø 140		Ø 300	
system power	↓15W standard		↓8W	
	↓23W high		-	
luminous flux	↓1077lm / ↓1508lm		↓1050lm	
UGR	<19		-	
color consistency	SDCM 3		SDCM 5	
light distribution - down	40°		150°	

Technical information



luminous efficiency	74lm/W	
electrical control	ON / OFF	▲ 9
	DALI (size M)	▲ 8
color temperature	3000K	● 3
	4000K	● 4
luminaire color	black (size M)	◆ 01
	white (size M)	◆ 02
reflector color	black (size M)	* 01
	white (size M)	* 02
	silver (size M)	* 04
	gold (size M)	* 05
fabric color	Flexica wool felt color palette FWxxxx - choose color from page 267	◆ FWxxxx

Create my unique code!

2127 - ■ - 2 - ▲ - ● - ◆ - * - 2 - ◆



M

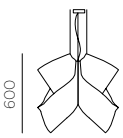
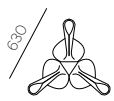

L

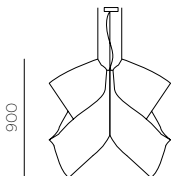
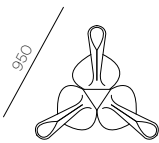

M

light distribution
DOWN

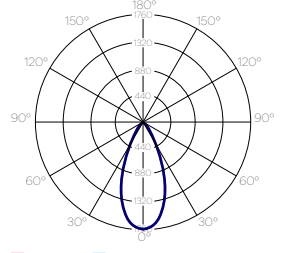

■ CO-C180 ■ C90-C270 cd/1000lm



Daisy

EN This pendant felt-made luminaire meets sophisticated user demands by combining sound-absorbing properties with contemporary lighting comfort in every modern office interior. Furthermore, Daisy luminaire is a handmade piece of art that gives sculptural experience when hanging in the collection. The Bloom Collection was designed in cooperation with Anna Spakowska.

DE Diese aus Filz gefertigte Pendelleuchte erfüllt anspruchsvolle Nutzeransprüche, indem sie schallabsorbierende Eigenschaften mit zeitgemäßem Lichtkomfort in jedem modernen Büointerieur verbindet. Darüber hinaus ist die Daisy-Leuchte ein handgefertigtes Kunstwerk, das beim Aufhängen in der Kollektion ein skulpturales Erlebnis vermittelt. Die Bloom Collection wurde in Zusammenarbeit mit Anna Spakowska entworfen.

Quickinfo

	Daisy M Daisy L	■ 01 ■ 02	Daisy XL	■ 03
luminaire size	M Ø 800 × 350 L Ø 1000 × 400		XL Ø 1200 × 450	
light source size	Ø 140			
system power	↓15W standard ↓23W high			
luminous flux	↓1077lm / ↓1508lm			
UGR	<19			
color consistency	SDCM 3			
light distribution - down	40°			

Technical information



luminous efficiency	74lm/W	
electrical control	ON/OFF	▲ 9
	DALI	▲ 8
color temperature	3000K	● 3
	4000K	● 4
luminaire color	black	◆ 01
	white	◆ 02
reflector color	black	* 01
	white	* 02
	silver	* 04
	gold	* 05
fabric color	Flexica wool felt color palette FWxxxx - choose color from page 267	◆ FWxxxx

Example

Daisy	standard power	4000K	reflector black	Flexica wool felt color 2318
↑	↑	↑	↑	↑
2128	- 02	- 2	- 8	- 4
	- 01	- 01	- 2	- FW2318
	↓	↓	↓	↓
	size L	DALI	luminaire black	pendant

Create my unique code!

2128 - ■ - 2 - ▲ - ● - ◆ - * - 2 - ◆

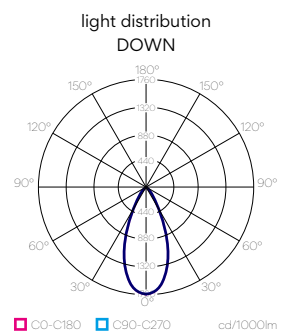
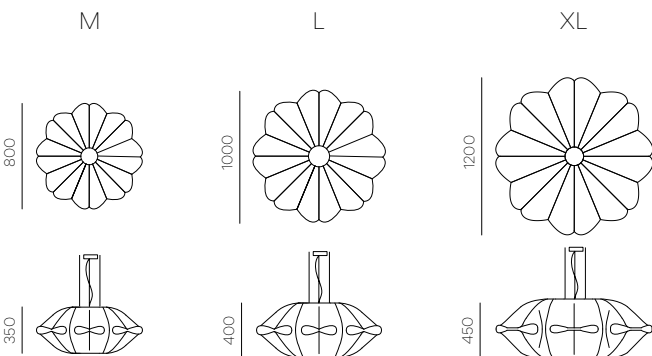

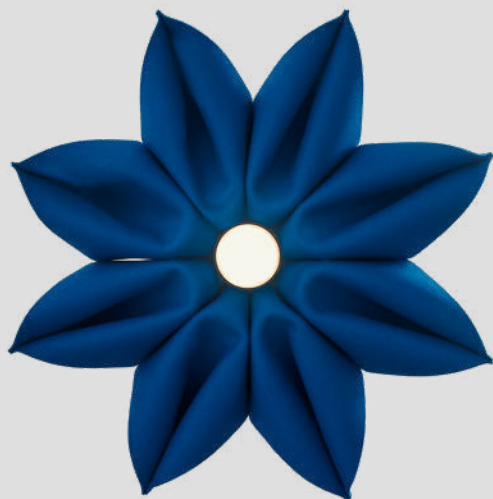

Rose

EN Rose is a pendant luminaire made from wool felt to achieve practical sound-absorbing qualities. The seemingly floating light source is discreetly integrated into the richly-textured felt shade to accomplish a unique contemporary feel. The luminaire contour exudes timeless aesthetics by pushing the felt material to the limit of its formability. The Bloom Collection was designed in cooperation with Anna Spakowska.

DE Rose ist eine Pendelleuchte aus Wollfilz, um praktische schallabsorbierende Eigenschaften zu erzielen. Die scheinbar schwebende Lichtquelle ist diskret in den reich strukturierten Filzschirm integriert, um ein einzigartiges zeitgenössisches Gefühl zu schaffen. Die Leuchtenkontur strahlt eine zeitlose Ästhetik aus, indem sie das Material Filz an die Grenze seiner Formbarkeit treibt. Die Bloom Collection wurde in Zusammenarbeit mit Anna Spakowska entworfen.

Example

Rose	standard power	4000K	reflector black	Flexica wool felt color 2318
↑	↑	↑	↑	↑
2129	- 02	- 2	- 8	- 4
				- 01
				- 01
				- 2
				- FW2318
	↓	↓	↓	↓
	size L	DALI	luminaire black	pendant

Quickinfo

	Rose M Rose L	■ 01 ■ 02	Rose XL	■ 03
luminaire size	M Ø 800×400 L Ø 1000×450		XL Ø 1200×500	
light source size	Ø 140		Ø 300	
system power	↓15W standard ↓23W high		↓8W	-
luminous flux	↓1077lm / ↓1508lm		↓1050lm	
UGR	<19		-	
color consistency	SDCM 3		SDCM 5	
light distribution - down	40°		150°	

Technical information



luminous efficiency	74lm/W	
electrical control	ON / OFF	▲ 9
	DALI (size M / L)	▲ 8
color temperature	3000K	● 3
	4000K	● 4
luminaire color	black	◆ 01
	white	◆ 02
reflector color	black	* 01
	white	* 02
	silver	* 04
	gold	* 05
fabric color	Flexica wool felt color palette FWxxxx - choose color from page 267	◆ FWxxxx

Create my unique code!

2129 - ■ - 2 - ▲ - ● - ◆ - * - 2 - ◆

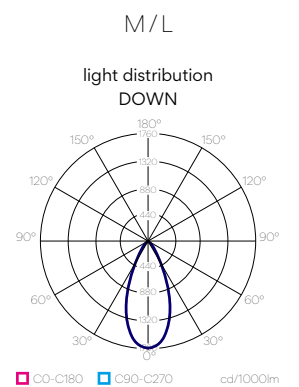
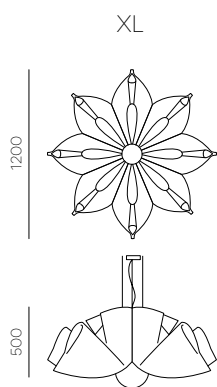
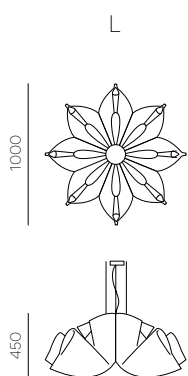
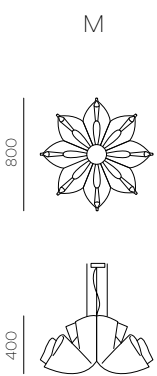

Acoustic fabric

EN The Acoustic fabric series is a line of inspiring lighting fixtures upholstered Synergy Camira fabrics and selected Gabriel fabrics. The selected materials are the epitome of the natural simplicity of textiles combined with rich texture. We also choose the highest quality fabrics with the addition of wool, which are irresistibly soft and highly efficient simultaneously. They are perfect for creating interiors with character where acoustic balance is the foremost priority.

DE Die Acoustic-Stoffserie ist eine Reihe inspirierender Leuchten, die mit Synergy Camira-Stoffen und ausgewählten Gabriel-Stoffen bezogen sind. Die ausgewählten Materialien sind der Inbegriff der natürlichen Schlichtheit von Textilien in Kombination mit reicher Textur. Wir wählen auch die hochwertigsten Stoffe mit dem Zusatz von Wolle, die unwiderstehlich weich und gleichzeitig hocheffizient sind. Sie eignen sich perfekt für die Gestaltung von charaktervollen Innenräumen, in denen die akustische Ausgewogenheit an erster Stelle steht.





ING KATOWICE MAŁECCY BIURO PROJEKTOWE



Roller

EN Acoustic Roller luminaire with an upholstered high-density acoustic lampshade. The materials used, such as a sponge, absorb a significant proportion of the sounds that reach it. Thanks to this and the high-quality lighting system used, it is an excellent choice for office workplaces, particularly in open-plan offices with considerable noise levels.

DE Acoustic Roller ist eine Akustiklampe mit besonders dichtem, gepolstertem Lampenschirm. Dank der verwendeten Materialien (u.a. Schwamm) absorbiert das Modell einen großen Teil der Umgebungsgeräusche. Dadurch und dank des verwendeten hochwertigen Beleuchtungssystems ist die Lampe ideal für Büroarbeitsplätze geeignet, insbesondere für Open Space-Flächen, in denen der Geräuschpegel enorm ist.

Create my unique code!

2112 - ■ - ~ - ▲ - ● - ◆ - * - 3 - ◆

Example

Roller	standard power	4000K	frame black 9005	Gabriel color 64124
↑	↑	↑	↑	↑
2112	- 01	- 2	- 8	- 4
				- 01
				- 01
				- 3
				- G64124
	↓	↓	↓	↓
	size MA	DALI	luminaire black	pendant up & down

Quickinfo

	Roller M A ■ 01 Roller M B ■ 06	Roller L A ■ 02 Roller L B ■ 07 Roller XL ■ 03	Roller XXL ■ 04 Roller XXXL ■ 05
luminaire size	Roller M Ø 800×350	Roller L Ø 1000×415 Roller XL Ø 1200×500	Roller XXL Ø 1500×500 Roller XXXL Ø 1950×500
light source size	A Ø 450×82 B Ø 320×57	Ø 600×82 Ø 320×57	Ø 900×82
UGR	<18	<17	<15

Technical information

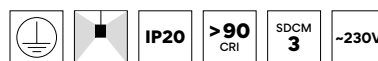

system power	A 30W ~ 2 ↑9W ↓21W	48W ~ 2 ↑14W ↓34W	80W ~ 2 ↑24W ↓56W
	B ↓10W ~ 1 ↓15W ~ 2 ↓20W ~ 3	↓10W ~ 1 ↓15W ~ 2 ↓20W ~ 3	~ 1 ~ 2 ~ 3
luminous flux	A ↑1000lm ↓2100lm	↑1750lm ↓3500lm	↑3400lm ↓5600lm
	B ↓1200lm ↓1800lm ↓2400lm	↓1200lm ↓1800lm ↓2400lm	
light distribution - up	100°		
light distribution - down	95°		
luminous efficiency	110lm/W		
electrical control	ON/OFF		▲ 9
	DALI		▲ 8
color temperature	3000K		● 3
	4000K		● 4
luminaire color	black (01/02/03/04/05)		◆ 01
	white		◆ 02
frame color	black 9005		* 01
	white 9010		* 02
fabric color	Synergy by Camira color palette LDSxxx - choose color from page 268		◆ LDSxxx
	Gabriel color palette Gxxx - choose color from page 269 - 273		◆ Gxxx



ING KATOWICE MAŁECCY BIURO PROJEKTOWE

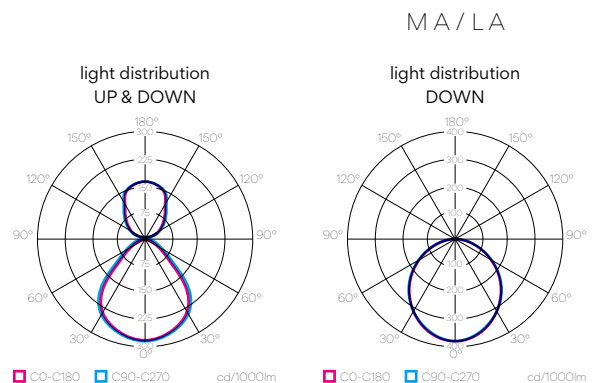
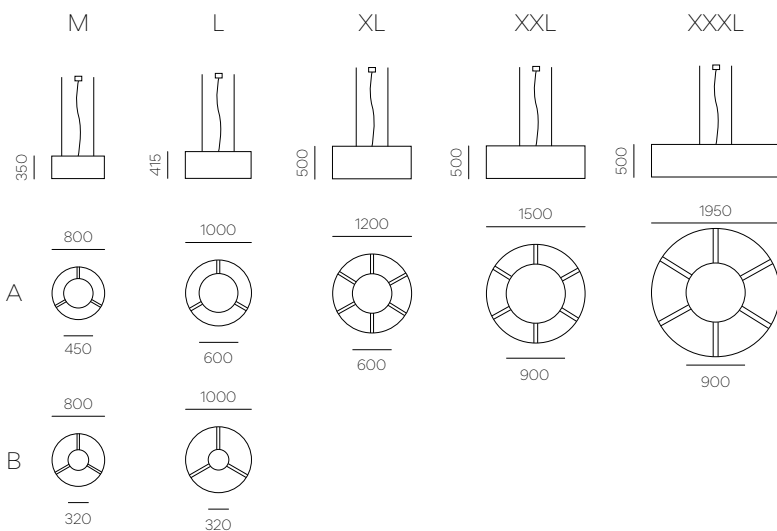



Cubber

EN The Acoustic Fabric Cubber Ceiling Lamp, a compact counterpart to the renowned Flexxica Roller, is a finely crafted luminaire. Upholstered in a wide selection of colors and fabrics, it boasts exceptional sound absorption capabilities, thanks to a premium acoustic sponge filling within the shade. This innovative design effectively absorbs a significant portion of incoming sounds. With an excellent lighting system, the lamp is particularly well-suited for office workspaces. Available in square sizes ranging from 80 cm to 150 cm, it caters to diverse office layout requirements, offering flexibility and adaptability.

DE Die Acoustic Fabric Cubber Ceiling Lamp, ein kompaktes Gegenstück zur bekannten Flexxica Roller, ist eine fein gearbeitete Leuchte. Sie ist in einer großen Auswahl an Farben und Stoffen erhältlich und verfügt über außergewöhnliche Schallabsorptionfähigkeiten dank einer hochwertigen Akustikschwammfüllung im Schirm. Dieses innovative Design absorbiert effektiv einen großen Teil der eingehenden Geräusche. Mit einem ausgezeichneten Beleuchtungssystem eignet sich die Leuchte besonders gut für Büroarbeitsplätze. Die Leuchte ist in quadratischen Größen von 80 cm bis 150 cm erhältlich und bietet Flexibilität und Anpassungsfähigkeit für die unterschiedlichsten Anforderungen an die Büroeinrichtung.

Create my unique code!

2165 - ■ - ~ - ▲ - ● - ◆ - * - 2 - ◆

Example

Cubber	standard power	4000K	frame black 9005	Gabriel color 64124
↑	↑	↑	↑	↑
2165	- 01	- 2	- 8	- 4
	↓	↓	↓	↓
	size M B	DALI	luminaire black	pendant
				01
				01
				2
				G64124

Quickinfo

	Cubber SA ■ 01	Cubber MA ■ 04	Cubber SB ■ 02	Cubber MB ■ 05	Cubber LB ■ 07	Cubber XLB ■ 09
	Cubber SC ■ 03	Cubber MC ■ 06	Cubber LC ■ 08	Cubber XLC ■ 10		
luminaire size	800×800×350	1000×1000×415	1200×1200×500	1500×1500×500		
light source	A 320×320×57	320×320×57	320×320×57	320×320×57		
source size	B 600×600×31	600×600×31	600×600×31	600×600×31		
	C Ø 450×82	Ø 600×82	Ø 600×82	Ø 900×82		
UGR	B <19	<19	<19	<19		
	C <18	<17	<17	<15		

Technical information

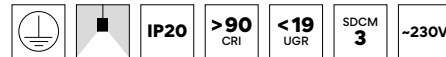

	S	M / L	XL	
system power	A ↓10W ~1	↓10W ~1	↓10W ~1	
	↓15W ~2	↓15W ~2	↓15W ~2	
	↓20W ~3	↓20W ~3	↓20W ~3	
	B 40W ~2	40W ~2	40W ~2	
luminous flux	C 30W ~2	48W ~2	80W ~2	
	(↑9W ↑21W)	(↑14W ↑34W)	(↑24W ↑56W)	
	A ↓1200lm	↓1200lm	↓1200lm	
light distribution - down	↓1800lm	↓1800lm	↓1800lm	
	↓2400lm	↓2400lm	↓2400lm	
	B ↓4500lm	↓4500lm	↓4500lm	
	light distribution - up	↑1000lm	↑1750lm	↑3400lm
		↑2100lm	↑3500lm	↑5600lm
		A S / M	150°	
luminous efficiency	B S / M / L / XL	90°		
	C S / M / L / XL	95°		
	C S / M / L / XL	100°		
electrical control	A S / M	120lm/W		
	B C S	110lm/W		
color temperature		ON/OFF	▲ 9	
		DALI	▲ 8	
	A S / M	3000K	● 3	
luminaire color		4000K	● 4	
		6000K	● 6	
	B C S	3000K	● 3	
frame color		4000K	● 4	
	C	black	◆ 01	
	A B C	white	◆ 02	
fabric color		black 9005	* 01	
		white 9010	* 02	
	Synergy by Camira color palette	◆ LDSxxx		
	LDSxxx - choose color from page 268	◆ Gxxxx		
	Gabriel color palette	◆ Gxxxx		
	Gxxxx - choose color from page 269 - 273			

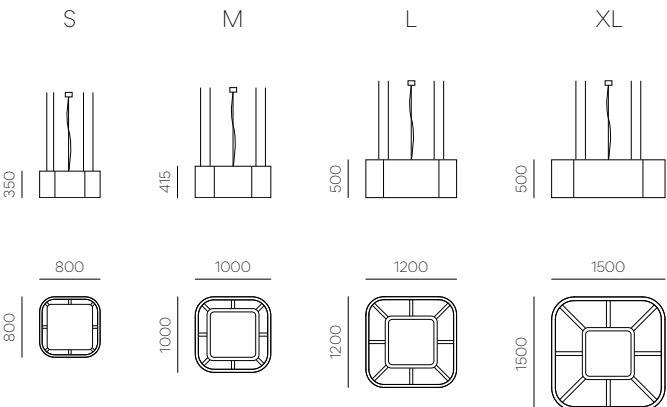

light distribution DOWN

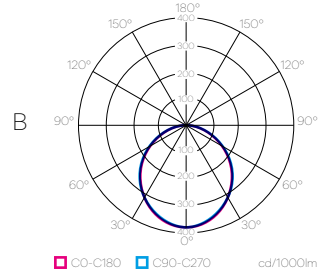

light distribution DOWN

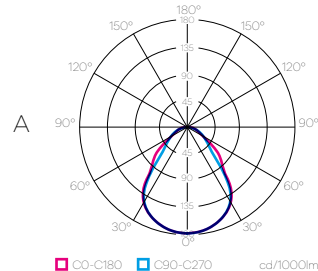

light distribution UP & DOWN

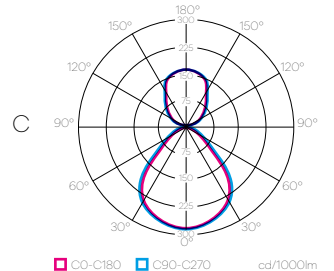



Roller Floor

EN Roller Floor is a free-standing lamp that brings acoustic balance and creates comfortable illumination for occupants below. Thanks to its impressive size and usage of an upholstered lampshade, we created a luminaire with exceptional sound absorption properties. It's an imposing floor lamp with a solid base, round and square to choose from, and a fancifully curved arm that holds the light source. High-performance LED light sources to offer superior performance, and a micro prismatic diffuser provides uniform illumination. Roller Floor fits perfectly into modern co-working spaces where unconventional design and maximum flexibility are in demand.

DE Roller Floor ist eine freistehende Leuchte, die ein akustisches Gleichgewicht schafft und eine angenehme Beleuchtung für die Bewohner darunter schafft. Dank ihrer beeindruckenden Größe und der Verwendung eines gepolsterten Lampenschirms haben wir eine Leuchte mit außergewöhnlichen schallabsorbierenden Eigenschaften geschaffen. Es ist eine imposante Stehlampe mit einem soliden Sockel, rund und quadratisch zur Auswahl, und einem fantasievoll geschwungenen Arm, der die Lichtquelle hält. Hochleistungs-LED-Lichtquellen für hervorragende Leistung und ein mikroprismatischer Diffusor für eine gleichmäßige Beleuchtung. Roller Floor fügt sich perfekt in moderne Co-Working Spaces ein, in denen unkonventionelles Design und maximale Flexibilität gefragt sind.

Example

Roller Floor	standard power	4000K	black 9005	Gabriel color 100
↑	↑	↑	↑	↑
2131 - 01 - 2 - 8 - 4 - 01 - 01 - 8 - G100				
	↓	↓	↓	↓
	round base	DALI	luminaire black	floor

Quickinfo

	Roller A	Roller B
luminaire size	1200×2111×1000	■ 01 ■ 02
light source size	Ø 600×82	
system power	48W (↑14W ↓34W)	
luminous flux	↑1750lm ↓3500lm	
UGR	<17	

Technical information

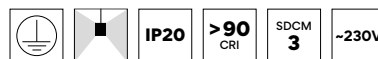

light distribution - up	100°	
light distribution - down	95°	
luminous efficiency	110lm/W	
electrical control	ON/OFF	▲ 9
	DALI	▲ 8
color temperature	3000K	● 3
	4000K	● 4
luminaire color	black	◆ 01
	white	◆ 02
frame color	black 9005	* 01
	white 9010	* 02
fabric color	Synergy by Camira color palette LDSxxx - choose color from page 268	◆ LDSxxx
	Gabriel color palette Gxxx - choose color from page 269 - 273	◆ Gxxx

Create my unique code!

2131 - ■ - 2 - ▲ - ● - ◆ - * - 8 - ◆

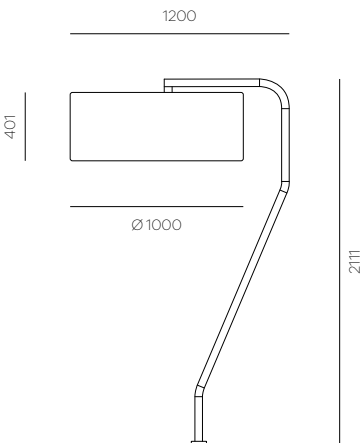

round base
Roller A

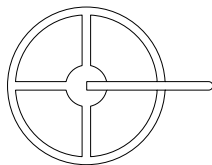

square base
Roller B

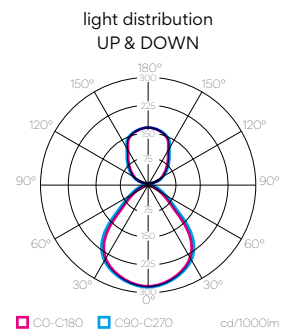
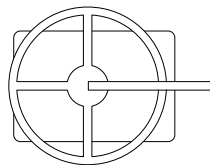



Ring

EN Acoustic luminaire shaped like a large circle. The lamp consists of a band-shaped light component around a soft panel. Due to its size, the lamp will work well in office spaces such as conference rooms. It will perfectly illuminate such spaces, giving them a touch of elegance and increasing the comfort of work.

DE Große kreisförmige Akustikleuchte. Die Lampe besteht aus einem bandförmigen Leuchtabschnitt rund um ein weiches Panel. Aufgrund ihrer Größe eignet sich die Lampe perfekt für Büroräume und Konferenzsäle. Das Modell beleuchtet derartige Räume perfekt, verleiht ihnen Eleganz und erhöht dabei den Arbeitskomfort.

Example

Ring	standard power	4000K	no frame	Gabriel color 123
↑	↑	↑	↑	↑
2103	- 01	- 2	- 8	- 4
		- 01	- 00	- 2
				- G123
	↓	↓	↓	↓
	size L	DALI	luminaire black 9005	pendant

Quickinfo

	Ring L ■ 01	Ring XL ■ 02	Ring XXL ■ 03
luminaire size	Ø 900×70	Ø 1200×70	Ø 1500×70

Technical information

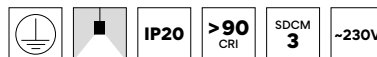

system power	↓55W / ↓82W / ↓100W
luminous flux	↓5200lm / ↓7800lm / ↓9000lm
UGR	<19
light distribution - down	symetric
luminous efficiency	95lm/W
electrical control	ON/OFF ▲ 9 DALI ▲ 8
color temperature	3000K ● 3 4000K ● 4 on request: TUNABLE WHITE ● 9
luminaire color	black 9005 ◆ 01 white 9010 ◆ 02
fabric color	Synergy by Camira color palette ◆ LDSxxx LDSxxx - choose color from page 268 Gabriel color palette ◆ Gxxx Gxxx - choose color from page 269 - 273 on request: Flexxica wool felt color palette ◆ FWxxxx FWxxxx - choose color from page 267 on request: Flexxica felt color palette ◆ FFxxxx FFxxxx - choose color from page 267

Create my unique code!

2103 - ■ - 2 - ▲ - ● - ◆ - 00 - 2 - ◆

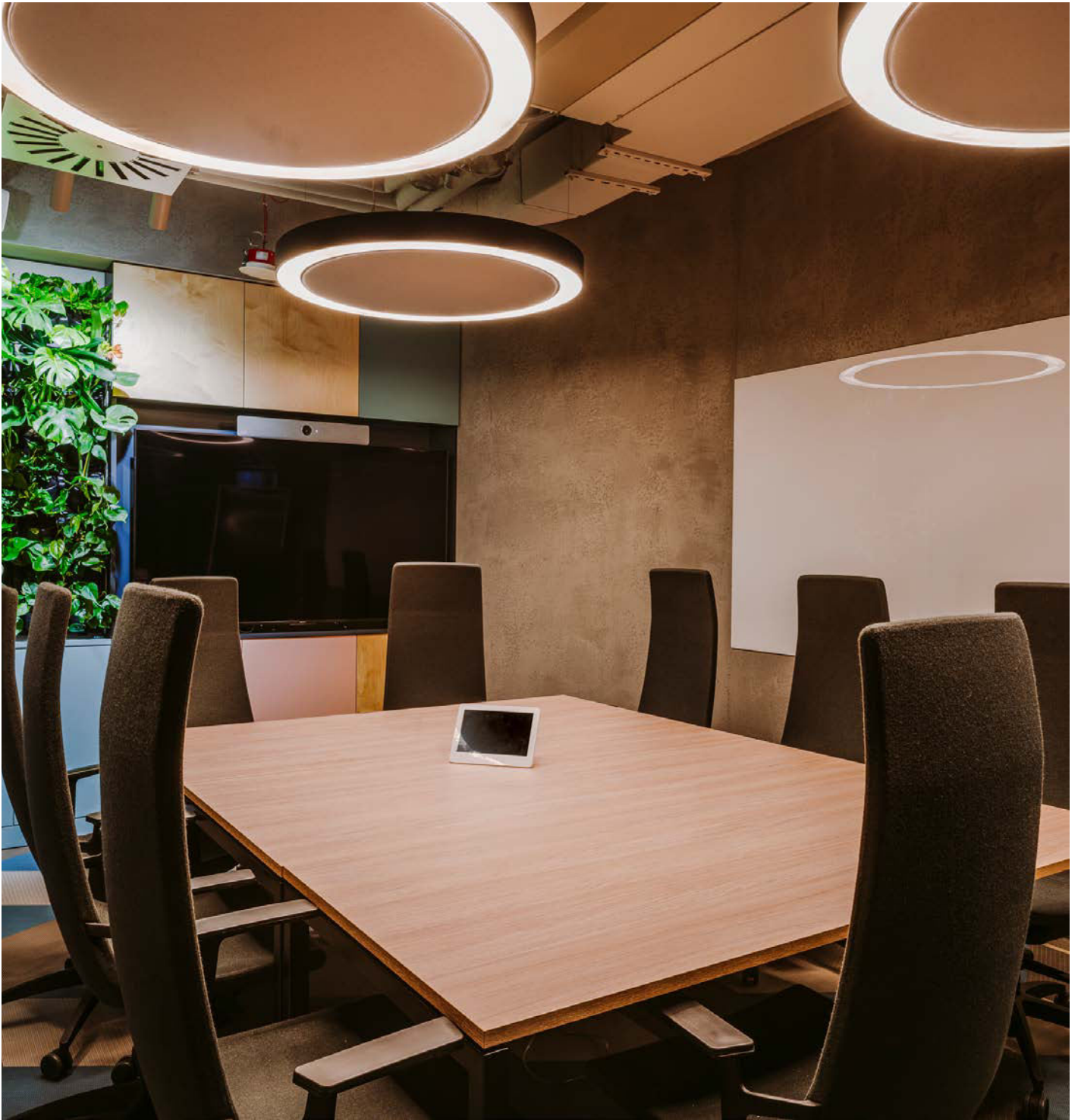

VODENO TRZOP ARCHITEKCI

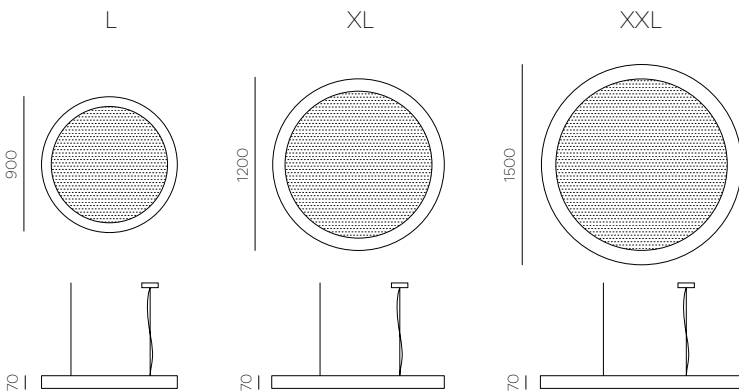

On request we can produce it in other sizes!

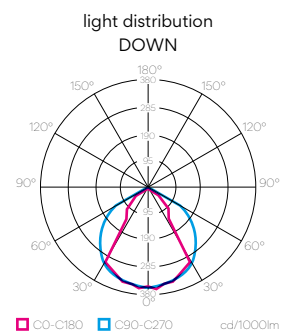

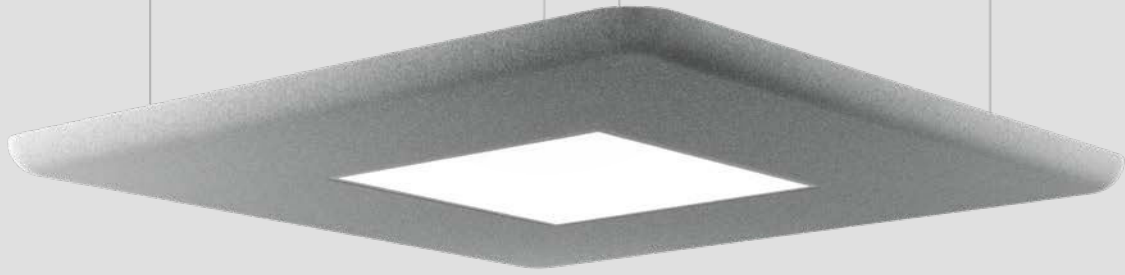

Square

EN This acoustic lamp has a geometric, slightly truncated shape. Both the inner light component and the surrounding acoustic panel are shaped like a square. The large surface area of the panel allows effective absorption of ambient sounds. The color of the panel is customisable. These features make the lamp a perfect choice for office workplaces, especially open-plan offices.

DE Akustiklampe in geometrischer, leicht geschnittener Form. Sowohl das Leuchtelement innen als auch das Akustikpaneel haben eine quadratische Form. Die große Oberfläche des Paneels sorgt für eine effektive Absorption der Umgebungsgereusche. Möglichkeit zur Personalisierung der Paneelfarbe. Dank dieser Eigenschaften ist die Lampe ideal für Büroarbeitsplätze geeignet, insbesondere für Open Space-Flächen.

Example

Square	standard power	4000K	no frame	Gabriel color 123
↑	↑	↑	↑	↑
2104	- 01	- 2	- 8	- 4
				- 02
				- 00
				- 2
				- G123
	↓	↓	↓	↓
	rounded corners & rounded edges	DALI	luminaire white	pendant

Quickinfo

	Square A ■ 01
	Square B ■ 02
on request:	Square C ■ 03
on request:	Square D ■ 04
luminaire size	1400x1400x55
light source size	600x600
system power	↓40W
luminous flux	↓4512lm
UGR	<19

Technical information



light distribution – down	90°
luminous efficiency	114lm/W
electrical control	ON / OFF ▲ 9
	DALI ▲ 8
color temperature	3000K ● 3
	4000K ● 4
luminaire color	white
fabric color	Synergy by Camira color palette ◆ LDSxxx LDSxxx – choose color from page 268
	Gabriel color palette ◆ Gxxx Gxxx – choose color from page 269 – 273

Create my unique code!

2104 - ■ - 2 - ▲ - ● - 02 - 00 - 2 - ◆

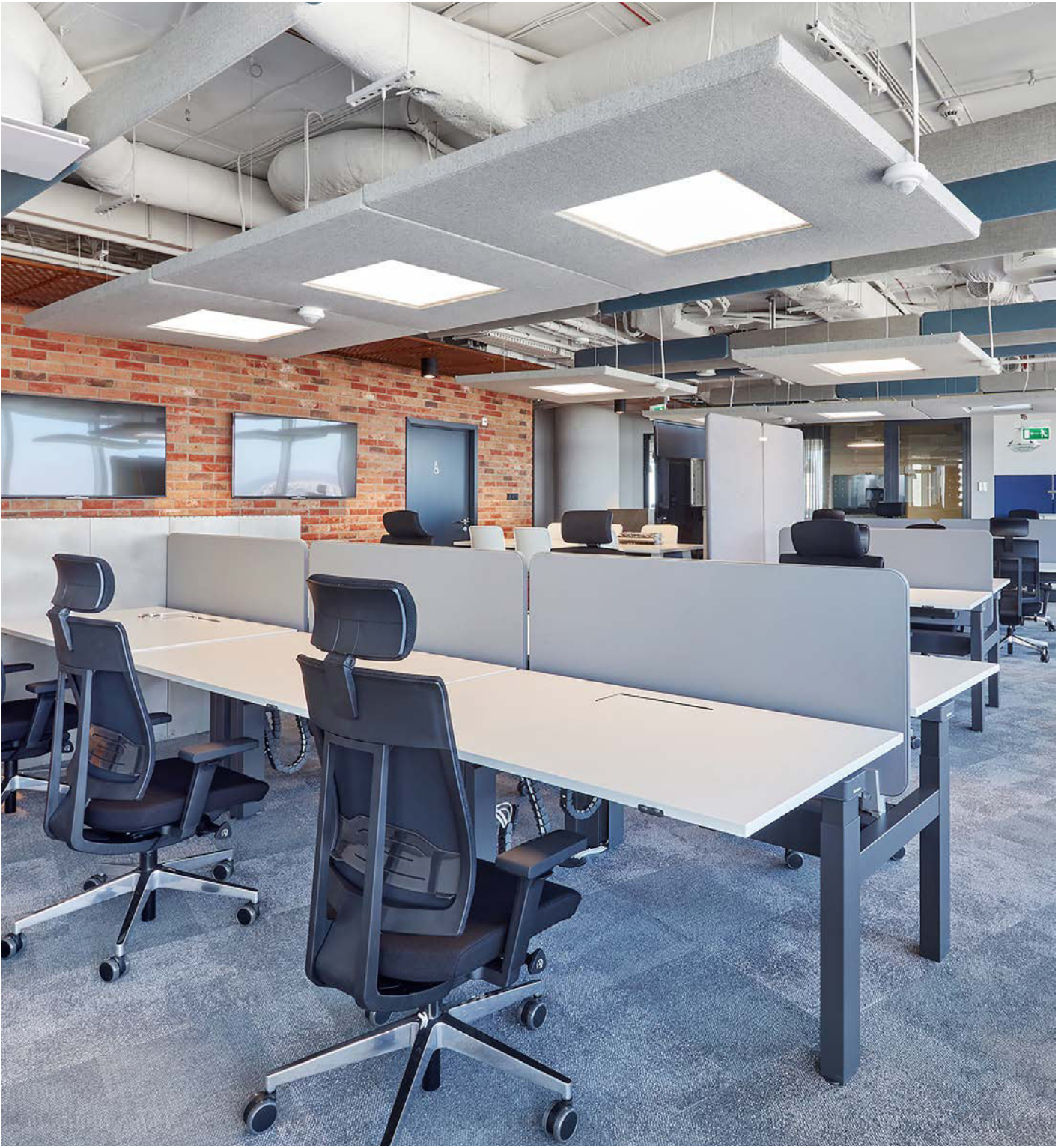

HL TECH TRZOP ARCHITEKCI

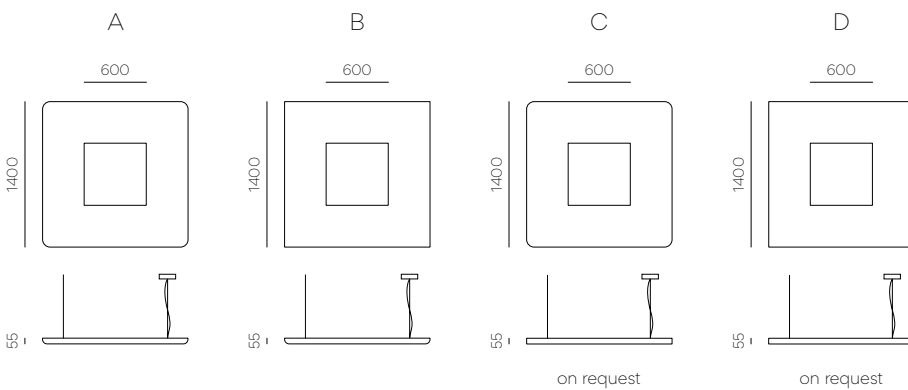

On request we can produce it in other sizes!

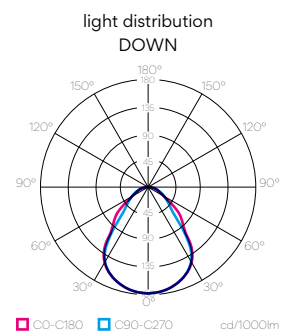

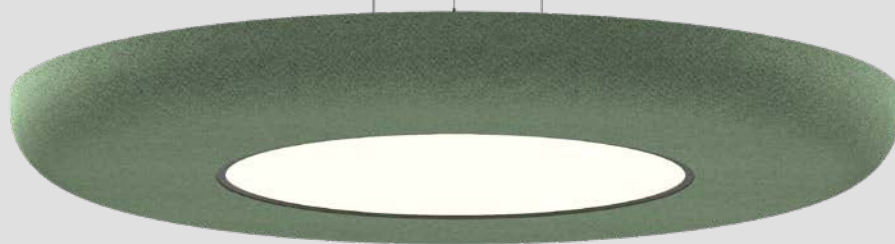

Round

EN Round lamp with upholstered acoustic panel. Equipped with a round light panel with excellent light characteristics, with a choice of light color and up/down lightning direction. The color of the lamp panel can be fully adjusted. Thanks to the materials used it absorbs a large proportion of the sounds that reach it. Combined with high-quality lighting components, it is ideal for office spaces, especially open plan offices.

DE Runde Lampe mit gepolstertem Akustikpaneel. Ausgestattet mit einem runden Leuchtpanel mit hervorragenden Beleuchtungsparametern und der Möglichkeit, die Lichtfarbe und die Beleuchtungsrichtung nach oben/unten zu wählen. Die Farbe des Lampenpaneels kann vollständig angepasst werden. Dank den verwendeten Materialien absorbiert die Lampe einen Großteil des Schalls, der sie erreicht. In Kombination mit hochwertigen Lichtkomponenten ist sie ideal für Büroräume, insbesondere Großraumbüros.

Example

Round standard power 4000K no frame Gabriel color 123
 ↑ ↑ ↑ ↑ ↑
 2105 - 01 - 2 - 8 - 4 - 01 - 00 - 3 - G123
 ↓ ↓ ↓ ↓
 M45 DALI luminaire pendant
 rounded edges black up & down

Quickinfo

	Round M45 Round L45 Round XL45	■ 01 ■ 02 ■ 03	Round L60 Round XL60 Round XXL60	■ 04 ■ 05 ■ 06
luminaire size	M45 Ø 800×55 L45 Ø 1000×55 XL45 Ø 1180×55		L60 Ø 1000×55 XL60 Ø 1180×55 XXL60 Ø 1400×55	
light source size	Ø 450×82		Ø 600×82	
system power	30W (↑9W ↓21W)		48W (↑14W ↓34W)	
luminous flux	↑1000lm ↓2100lm		↑1750lm ↓3500lm	
UGR	< 18		< 17	

Technical information

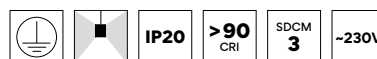

light distribution - up	100°
light distribution - down	95°
luminous efficiency	110lm/W
electrical control	ON/OFF ▲ 9 DALI ▲ 8
color temperature	3000K ● 3 4000K ● 4
luminaire color	black ● 01 white ● 02
fabric color	Synergy by Camira color palette ◆ LDSxxx LDSxxx - choose color from page 268 Gabriel color palette ◆ Gxxx Gxxx - choose color from page 269 - 273

Create my unique code!

2105 - ■ - 2 - ▲ - ● - ◆ - 00 - 3 - ◆

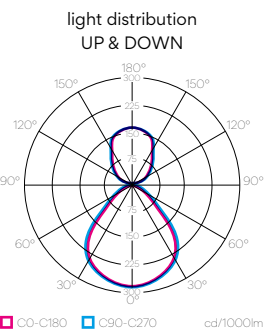
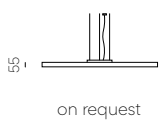
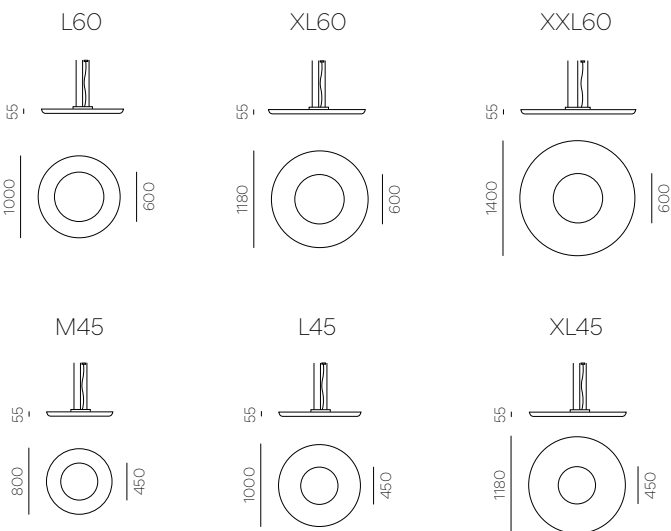
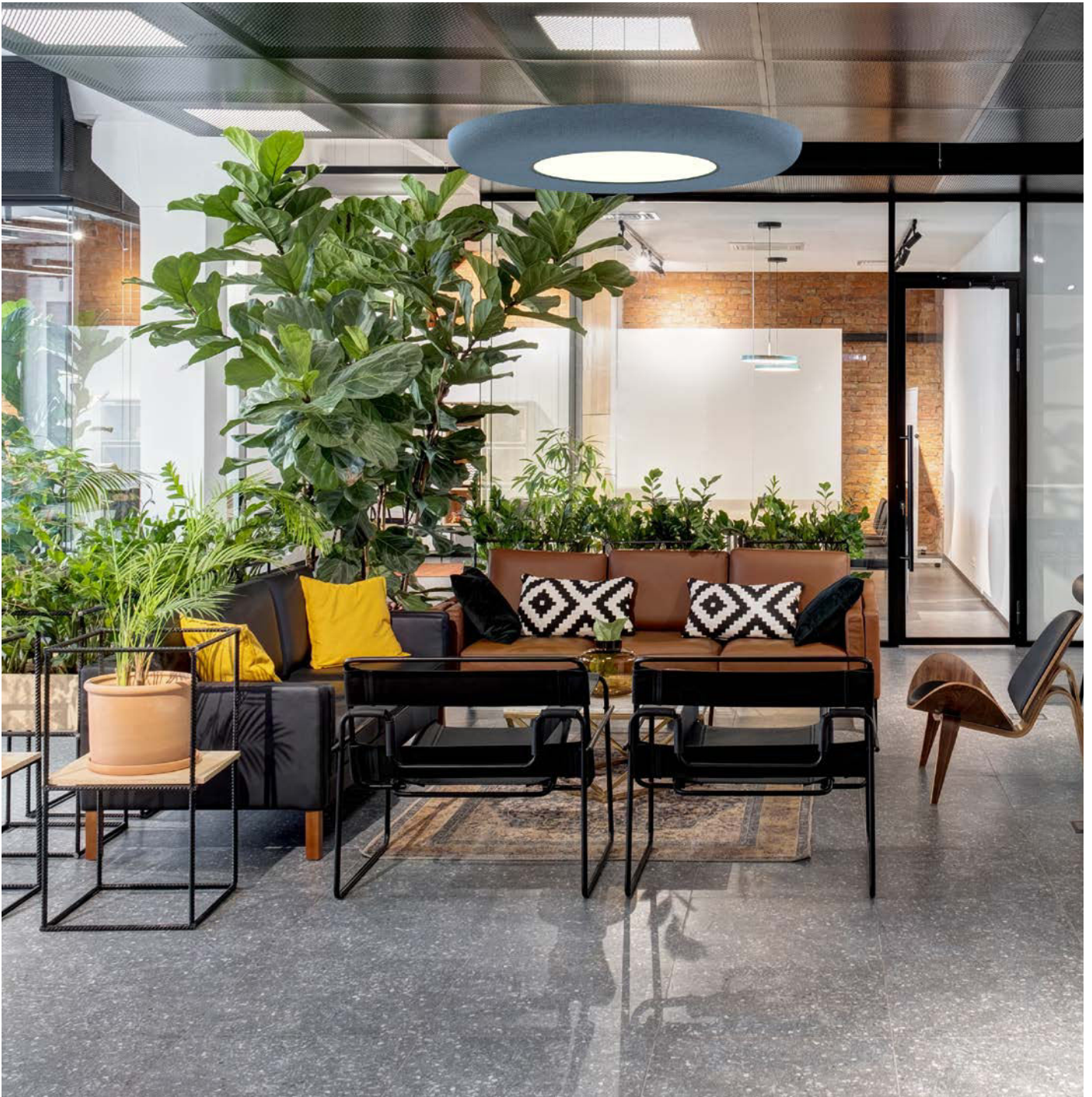



Island

EN Acoustic luminaire in XXL size. With its large surface panel, it is suitable for open-plan offices or conference rooms. It absorbs a significant amount of the surrounding sound. The full panel creates an eye-catching feature in the space. Panel sizes and colors are fully customisable.

DE Akustiklampe im XXL-Format. Dank des großflächigen Panels eignet sich das Modell perfekt für Open Space-Büros oder Konferenzräume. Die Lampe absorbiert einen großen Teil der Geräusche aus der unmittelbaren Umgebung. Vollständiges Panel – interessantes Element im Raum. Passen Sie Größe und Farbe des Panels an die Anforderungen Ihres Projekts an.

Quickinfo

luminaire size	1500×600×55	1500×600×55
light source size	83×83	83×83
system power	2 × ↓10W ■ 01	2 × ↓15W ■ 02
luminous flux	2 × ↓1060lm	2 × ↓1530lm
UGR	<16	<16

Technical information

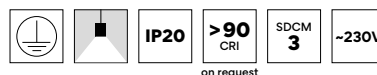

light distribution - down	80°
luminous efficiency	100lm/W
electrical control	ON / OFF ▲ 9 DALI ▲ 8
color temperature	3000K ● 3 4000K ● 4 on request: TUNABLE WHITE ● 9
luminaire color	black 9005 ● 01 on request: RAL color palette ● 99
fabric color	Synergy by Camira color palette LDSxxx – choose color from page 268 ◆ LDSxxx Gabriel color palette Gxxx – choose color from page 269 – 273 ◆ Gxxx

Example

Island standard power 4000K no frame Gabriel color 123
 ↑ ↑ ↑ ↑ ↑
 2106 - 01 - 2 - 8 - 4 - 01 - 00 - 2 - G123
 ↓ ↓ ↓ ↓
 2×10W DALI luminaire black 9005 pendant

Create my unique code!

2106 - ■ - 2 - ▲ - ● - ◆ - 00 - 2 - ◆



SHOWROOM HUMAN OFFICE

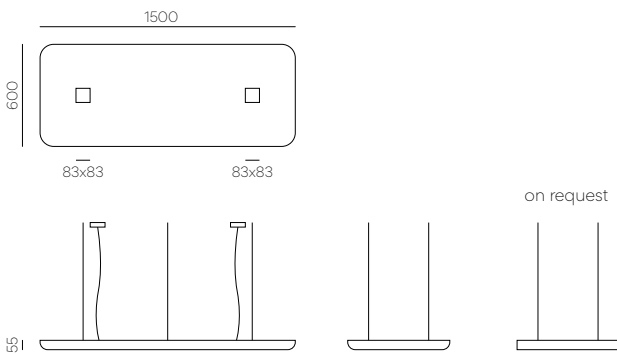

On request we can produce it in other sizes and with more light sources!

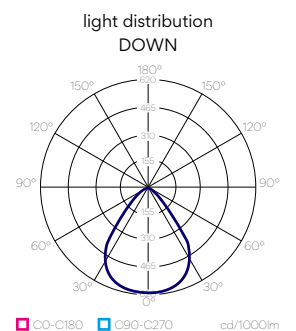



Gap Round

EN Round lamp with an upholstered acoustic panel. The distinctive cut-out gives it a unique designer look. The panel color is fully customisable. The materials absorb a considerable part of the surrounding sounds. This, with its high-quality lighting components, makes it perfect for offices, particularly in open-plan spaces.

DE Runde Lampe mit gepolstertem Akustikpaneel. Die charakteristische Kerbe sorgt für einen einzigartigen Designer-Look. Unbegrenzte Möglichkeiten zur Personalisierung der Paneelfarbe. Dank der verwendeten Materialien absorbiert die Lampe einen großen Teil der Geräusche, die sie erreichen. Aufgrund der hochwertigen Beleuchtungskomponenten eignet sich die Lampe ideal für Büroräume, insbesondere für Open Space-Flächen.

Example

Gap Round standard power 4000K no frame Gabriel color 123

↑ ↑ ↑ ↑ ↑

2108 - 01 - 2 - 8 - 4 - 01 - 00 - 3 - G123

↓ ↓ ↓ ↓

M45 DALI luminaire black pendant up & down

Quickinfo

	M45 L45 XL45	■ 01 ■ 02 ■ 03	L60 XL60 XXL60	■ 04 ■ 05 ■ 06
luminaire size	M45 L45 XL45	∅ 800×55 ∅ 1000×55 ∅ 1180×55	L60 XL60 XXL60	∅ 1000×55 ∅ 1180×55 ∅ 1400×55
light source size	∅ 450×82		∅ 600×82	
system power	30W (↑9W ↓21W)		48W (↑14W ↓34W)	
luminous flux	↑1000lm ↓2100lm		↑1750lm ↓3500lm	
UGR	<18		<17	

Technical information

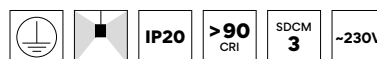

light distribution - up	100°
light distribution - down	95°
luminous efficiency	110lm/W
electrical control	ON/OFF ▲ 9 DALI ▲ 8
color temperature	3000K ● 3 4000K ● 4
luminaire color	black ● 01 white ● 02
fabric color	Synergy by Camira color palette ◆ LDSxxx LDSxxx - choose color from page 268 Gabriel color palette ◆ Gxxx Gxxx - choose color from page 269 - 273

Create my unique code!

2108 - ■ - 2 - ▲ - ● - ◆ - 00 - 3 - ◆



ING KATOWICE MAŁECCY BIURO PROJEKTOWE

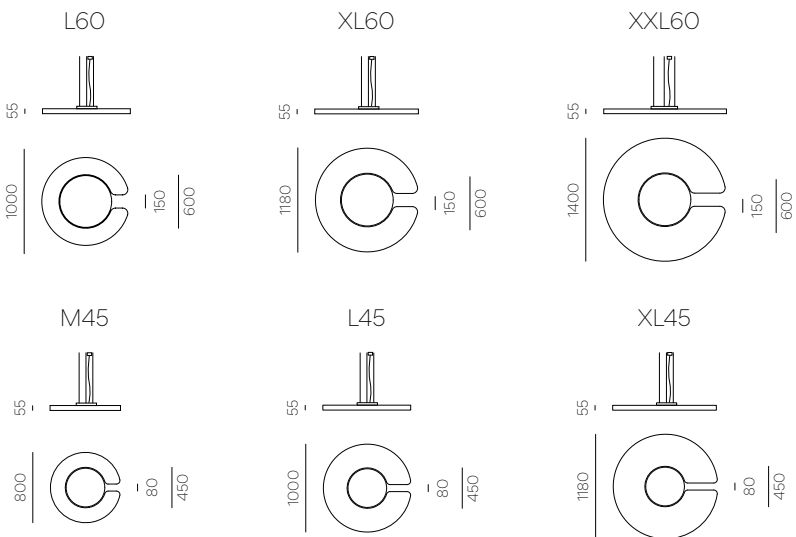

On request we can produce it in other sizes!

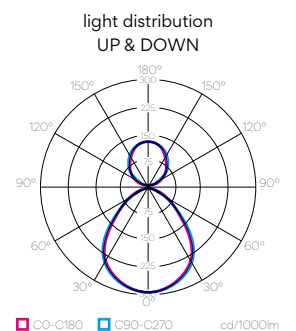

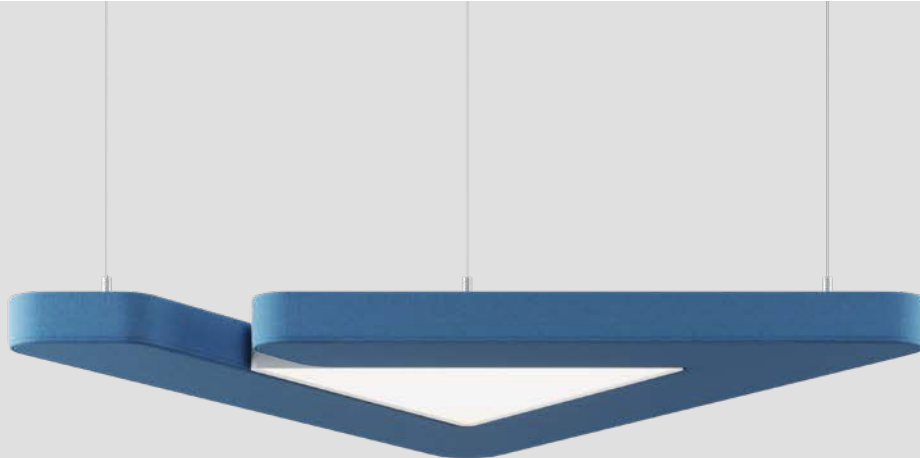

Gap Triangle

EN Triangular lamp with an upholstered acoustic panel. The distinctive cut-out gives it a unique designer look. The panel color is fully customisable. The materials absorb a considerable part of the surrounding sounds. This, with its high-quality lighting components, makes it perfect for offices, particularly in open-plan spaces.

DE Dreieckige Lampe mit gepolstertem Akustikpaneel. Die charakteristische Kerbe sorgt für einen einzigartigen Designer-Look. Unbegrenzte Möglichkeiten zur Personalisierung der Paneelfarbe. Dank der verwendeten Materialien absorbiert die Lampe einen großen Teil der Geräusche, die sie erreichen. Aufgrund der hochwertigen Beleuchtungskomponenten eignet sich die Lampe ideal für Büroräume, insbesondere für Open Space-Flächen.

Example

Gap Triangle	standard power	4000K	no frame	Gabriel color 123
↑	↑	↑	↑	↑
2109 - 00	- 2 - 8	- 4 - 01	- 00 - 2	- G123
↓	↓	↓	↓	
one size	DALI	luminaire black	pendant	

Quickinfo

luminaire size	1007×71
light source size	496×71
system power	≈50W
luminous flux	≈4200lm
UGR	<19

Technical information

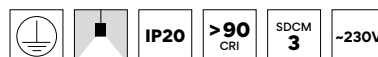

light distribution – down	60°
luminous efficiency	84lm/W
electrical control	ON/OFF ▲ 9 DALI ▲ 8
color temperature	3000K ● 3 4000K ● 4 on request: TUNABLE WHITE ● 9
luminaire color	black ◆ 01 white ◆ 02
fabric color	Synergy by Camira color palette ◆ LDSxxx LDSxxx – choose color from page 268 Gabriel color palette ◆ Gxxx Gxxx – choose color from page 269–273

Create my unique code!

2109 - 00 - 2 - ▲ - ● - ◆ - 00 - 2 - ◆

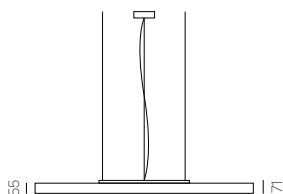
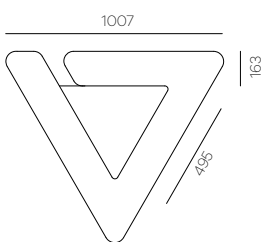

On request we can produce it in other sizes!



Gap Island

EN Acoustic luminaire in XXL size. With its large surface panel, it is suitable for open-plan offices or conference rooms. It absorbs a significant amount of the surrounding sound. The panel has a characteristic cut-out, which is an eye-catching detail that adds lightness to the lamp. Panel sizes and colors are fully customisable.

DE Akustiklampe im XXL-Format. Dank des großflächigen Paneels eignet sich das Modell perfekt für Open Space-Büros oder Konferenzräume. Die Lampe absorbiert einen großen Teil der Geräusche aus der unmittelbaren Umgebung. Das Paneel hat eine charakteristische Kerbe – ein auffälliges Detail, das der Lampe Leichtigkeit verleiht. Passen Sie Größe und Farbe des Paneels an die Anforderungen Ihres Projekts an.

Example

Gap Island	standard power	4000K	no frame	Gabriel color 100
↑	↑	↑	↑	↑
2110 - 01 - 2 - 8 - 4 - 01 - 00 - 2 - G100				
↓	↓	↓	↓	
size L	DALI	luminaire black	pendant up & down	

Quickinfo

	L	■ 01	XL	■ 02
luminaire size	1700×1000×35		2300×1000×35	
light source size	1200×240×33		1800×240×33	
system power	50W (↑20W ↓30W)		80W (↑32W ↓48W)	
luminous flux	↑2700lm ↓3650lm		↑4320lm ↓5840lm	
UGR	<19		<19	

Technical information

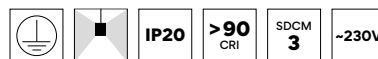

light distribution - up	115°
light distribution - down	80°
luminous efficiency	125lm/W
electrical control	ON/OFF ▲ 9 DALI ▲ 8
color temperature	3000K ● 3 4000K ● 4 on request: TUNABLE WHITE ● 9
luminaire color	black ● 01 white ● 02
fabric color	Synergy by Camira color palette LDSxxx - choose color from page 268 ◆ LDSxxx Gabriel color palette Gxxx - choose color from page 269 - 273 ◆ Gxxx

Create my unique code!

2110 - ■ - 2 - ▲ - ● - ◆ - 00 - 3 - ◆

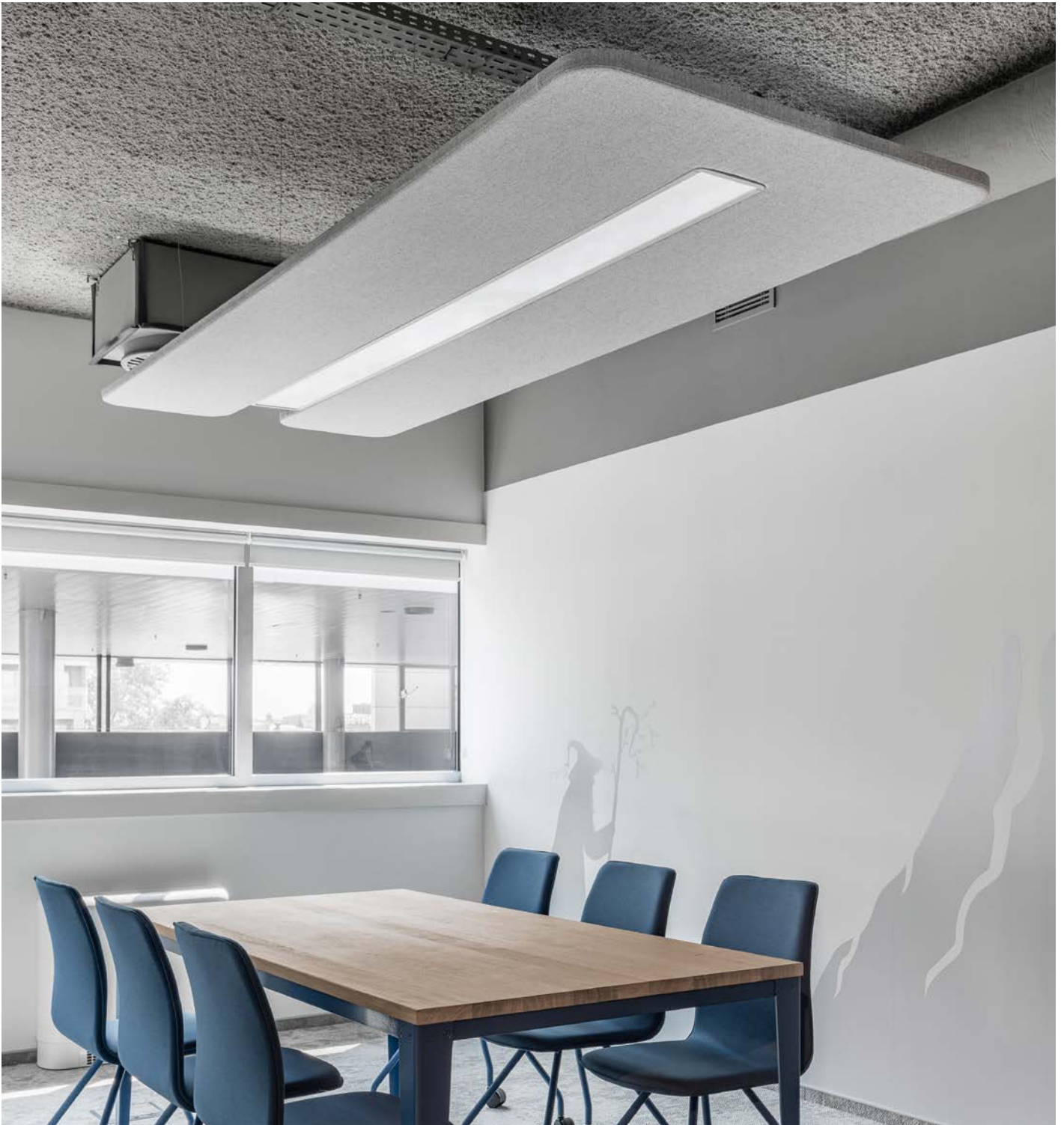

ING KATOWICE MAŁECCY BIURO PROJEKTOWE

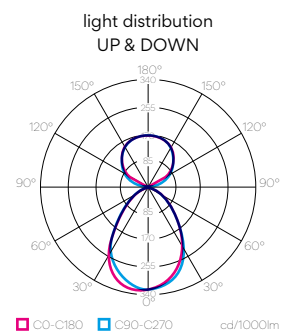
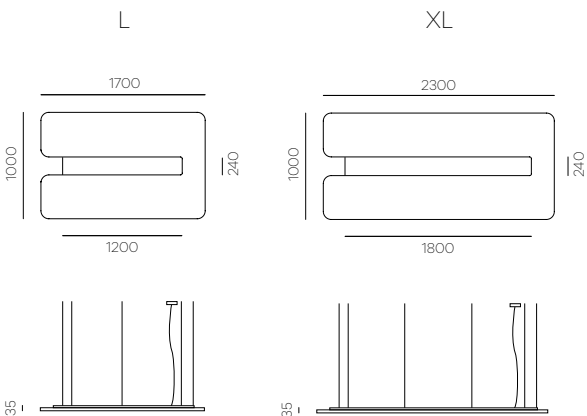



Gaya

EN A distinctive lamp inspired by biophilic design. The lamp consists of two acoustic panels, a light component and an inner shield shaped like a plant pot to plant anything. The luminaire not only perfectly illuminates the workplace but also enhances the visual value of the interior and gives it a classy character. The color of all the components of the lamp is customisable.

The lamp was designed in collaboration with Trzop Architekci, arch. Małgorzata Szlązek.

DE Charakteristische Lampe im Biophilic Design-Look. Die Lampe besteht aus zwei Akustikpaneels, einem Leuchtelement und einem Innenschirm in Form eines Blumentopfes für Pflanzen. Die Lampe beleuchtet nicht nur den Arbeitsplatz perfekt, sondern erhöht auch den visuellen Wert des Raums und verleiht ihm ein elegantes Flair. Möglichkeit zur Personalisierung der Farbe aller Komponenten der Lampe.

Die Lampe wurde in Zusammenarbeit mit Trzop Architekci, arch. Małgorzata Szlązek.

Example

Gaya	standard power	4000K	frame cooper	Gabriel color 100
↑	↑	↑	↑	↑
2111 - 00	- 2	- 8	- 4	- 01
	- 03	- 2	- G100	
↓	↓	↓	↓	
one size	DALI	luminaire black 9005	pendant	

Quickinfo

luminaire size	826×241×248
system power	↓35W
luminous flux	↓2000lm

Technical information

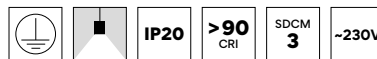

light distribution - down	60°
luminous efficiency	60lm/W
electrical control	ON / OFF ▲ 9 DALI ▲ 8
color temperature	3000K ● 3 4000K ● 4
luminaire color	black 9005 ● 01 white 9010 ● 02
frame color	black 9005 * 01 white 9010 * 02 copper * 03
fabric color	Synergy by Camira color palette ◆ LDSxxx LDSxxx - choose color from page 268 Gabriel color palette ◆ Gxxx Gxxx - choose color from page 269 - 273

Create my unique code!

2111 - 00 - 2 - ▲ - ● - ◆ - * - 2 - ◆

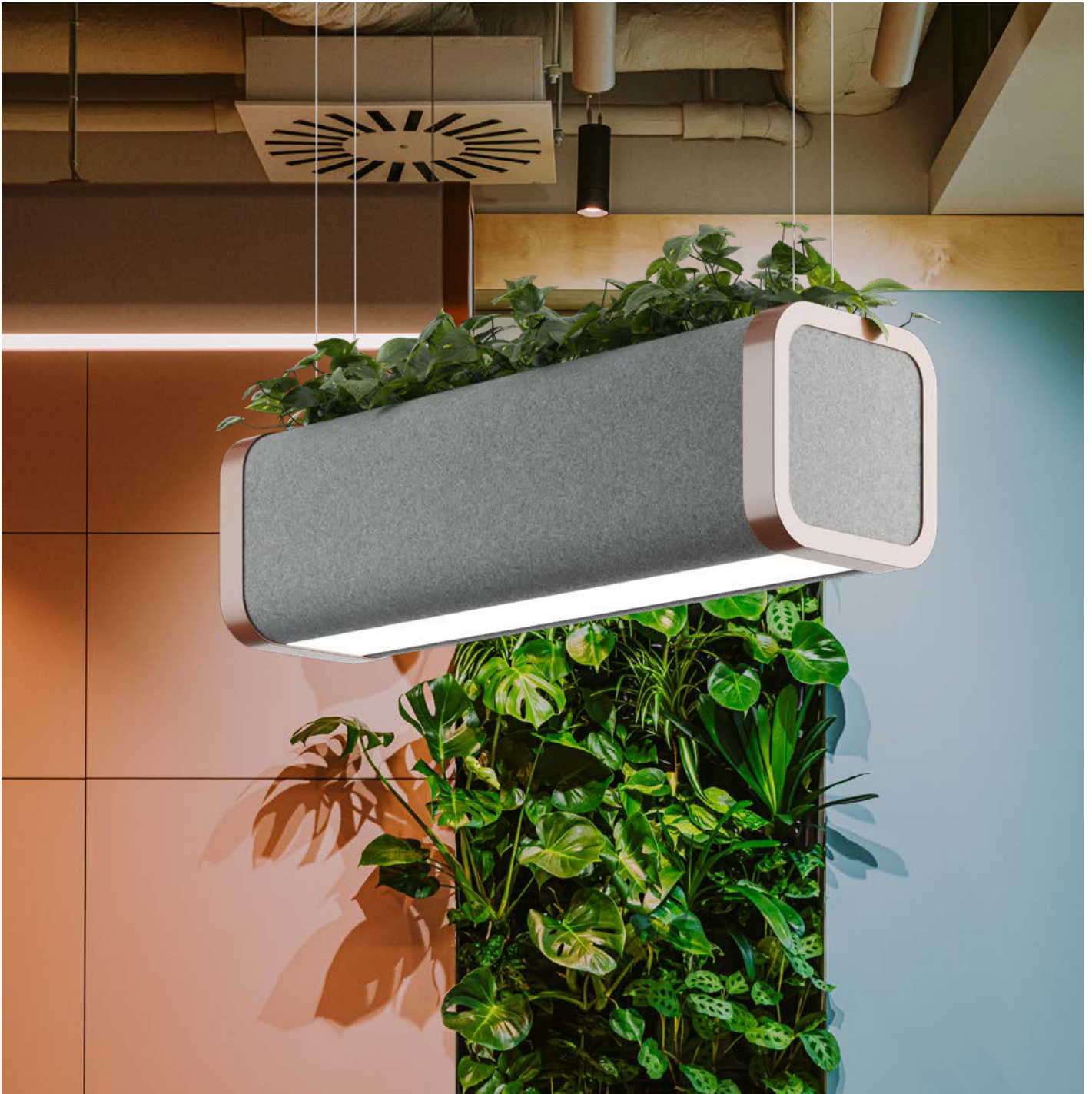

VODENO TRZOP ARCHITEKCI

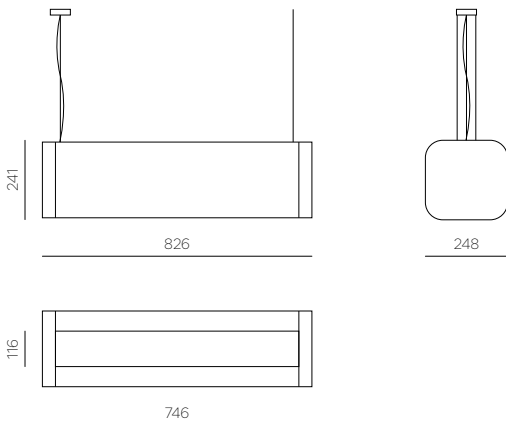



Sphere

EN Round lamp with upholstered acoustic panel. The distinctive hanging sphere in the center of the panel gives it a unique, designer look. The color of the lamp panel can be fully customized. Thanks to the materials used, it absorbs a large proportion of the sound that reaches it. Paired with high-quality light components, it is ideal for office spaces, especially for open-plan offices.

DE Runde Lampe mit gepolstertem Akustikpaneel. Die charakteristische hängende Kugel in der Mitte des Paneels verleiht ihr einen einzigartigen Designerlook. Bei dieser Lampe kann die Farbe des Paneels beliebig personalisiert werden. Dank der verwendeten Materialien absorbiert das Modell einen erheblichen Teil der Umgebungsgläusche. Angesichts der gleichzeitigen Verwendung hochwertiger Beleuchtungskomponenten eignet sich die Lampe ideal für Büroräume, und insbesondere für Open Space-Flächen.

Example

Sphere	standard power	4000K	no frame	Gabriel color 100
↑	↑	↑	↑	↑
2116 - 00	- 2 - 8	- 4 - 21	- 00 - 2	- G100
↓	↓	↓	↓	↓
one size	DALI	luminaire chrome	pendant	

Quickinfo

luminaire size	Ø 800×400
light source size	Ø 400×400
system power	3 × 48W
light source flux	3 × 1050lm

Technical information

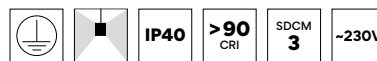

light distribution - up	150°	
light distribution - down	150°	
electrical control	ON / OFF	▲ 9
	on request: DALI	▲ 8
color temperature	3000K	● 3
	4000K	● 4
luminaire color	chrome	
fabric color	Synergy by Camira color palette LDSxxx - choose color from page 268	◆ LDSxxx
	Gabriel color palette Gxxx - choose color from page 269 - 273	◆ Gxxx

Create my unique code!

2116 - 00 - 2 - ▲ - ● - 21 - 00 - 2 - ◆



CMS LAW FIRM TRZOP ARCHITEKCI

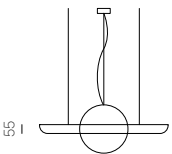
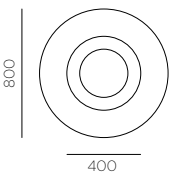

On request we can produce it in other sizes!

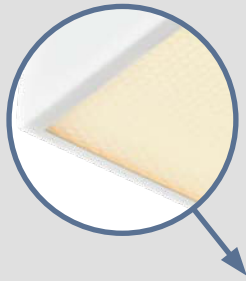

Panel

EN Luminaire is designed using a lightweight acoustic composite. With its simple form and large surface area, the lamp absorbs most of the sounds reaching its surface. The composite in its honeycomb pattern and structure adds depth to the simple geometric design of the luminaire. The composite also provides excellent light diffusion, making the lamp perfect for office workspaces. The lamp has a modular form and allows any combination and duplication of the shape of a single component.

DE Entwickelt auf Basis eines leichten akustischen Verbundwerkstoffs. Dank der schlichten Form und großen Oberfläche absorbiert die Lampe die meisten Geräusche in der unmittelbaren Umgebung. Der Verbundstoff mit Wabenmuster und -struktur verleiht der einfachen geometrischen Struktur besondere Tiefe. Der Verbundstoff sorgt für die perfekte Streuung des Lichts und macht die Lampe zur idealen Wahl für Büroarbeitsplätze. Die Lampe hat eine modulare Form – beliebige Kombinationsmöglichkeiten und Vervielfältigung der Form eines einzelnen Elements.

Example

Panel	standard power	4000K	no frame	no textil
↑	↑	↑	↑	↑
2115	- 01	- 2	- 8	- 4
	↓	↓	↓	↓
	size M28	DALI	luminaire white 9010	pendant

Quickinfo

	S31	■ 01
	L31	■ 02
	S58	■ 03
	M58	■ 04
	L58	■ 05
luminaire size	S31	310×580×70
	L31	310×1120×70
	S58	580×580×70
	M58	580×850×70
	L58	580×1120×70
system power	↓65W*	
luminous flux	↓6700lm*	
UGR	<19	

Technical information

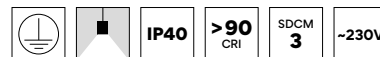

light distribution - down	91°
luminous efficiency	104lm/W*
electrical control	ON/OFF ▲ 9
	DALI ▲ 8
color temperature	3000K ● 3
	4000K ● 4
luminaire color	white 9010

* Photometric data for L58 size.

Create my unique code!

2115 - ■ - 2 - ▲ - ● - 02 - 00 - 2 - 00

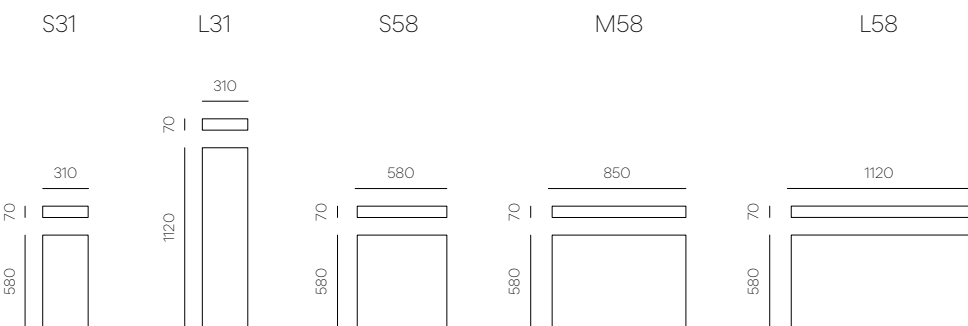



Design



CMS LAW FIRM TRZOP ARCHITEKCI

Wire Medusa

This product introduces new quality of visual and spatial experience in its class.

Wire medusa's form refers to the classic archetype of the chandelier. A clear dimensional shape is composed of individual segments of bent wire. Despite its size it feels airy and light. The wire is bent perpendicularly. The parallax effect accentuated by the light emanating from the lamp's centre, creates a sculptural spectacle. It is an engaging experience in space. By moving around it, we can see the interplay of shapes and light. Shadows cast onto walls, give off a mysterious and sophisticated feel.



reddot winner 2021



Every lampshade is made of identical segments that are arranged around the light source.



Wire Medusa



reddot winner 2021

EN This light fixture offers a new quality of visual experience in its class. The shape of the Wire Medusa luminaire is based on a classic chandelier. The distinctive spacious shape consists of individual pieces of wire. Despite its size, it appears lightweight and open. The parallax effect, emphasized by the light emanating from the center of the lamp, creates a sculptural spectacle. As you walk around the lamp, you can see the interplay of shapes and light.

Wire Medusa was awarded the prestigious Red Dot Award: Product Design 2021

Designed by Kabo & Pydo – Design Studio

DE Dieses Beleuchtungsprodukt führt eine neue Qualität der visuellen Eindrücke in seiner Klasse ein. Die Form der Wire Medusa-Lampe knüpft an klassische Kronleuchter an. Die klare räumliche Form besteht aus einzelnen Drahtelementen. Trotz ihrer Größe wirkt die Lampe leicht und einladend. Der Parallaxen-Effekt, der durch das aus der Mitte der Lampe ausgehende Licht verstärkt wird, schafft ein skulpturartiges Spektakel. Wenn Sie um die Lampe herumgehen, sehen Sie ein beeindruckendes Zusammenspiel von Formen und Licht.

Die Wire Medusa Leuchte wurde mit der prestigeträchtigen Auszeichnung Red Dot: Product Design 2021 ausgezeichnet

Entw. Kabo & Pydo – Design Studio

Example

Wire Medusa	standard power	4000K	no frame	no textil
↑	↑	↑	↑	↑
5101 - 01	- 2	- 8	- 4	- 10 - 00
	↓	↓	↓	↓
Long A	DALI	luminaire Red Orange RAL 2001	pendant	

Quickinfo

Long A ■ 01
Long B ■ 02
Wide A ■ 03
Wide B ■ 04

luminaire size	Long A & Long B – 444x1008 Wide A & Wide B – 702x809
system power	↓13.5W
luminous flux	↓1080lm

Technical information

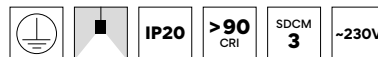

light distribution – down	90°
luminous efficiency	80lm/W
electrical control	ON / OFF ▲ 9 DALI ▲ 8
color temperature	3000K ● 3 4000K ● 4
luminaire color	RAL 1011 Brown Beige ● 08 RAL 1014 Ivory ● 09 RAL 2001 Red Orange ● 10 RAL 3012 Beige Red ● 11 RAL 5002 Ultramarine Blue ● 12 RAL 6013 Reed Green ● 13 RAL 7032 Pebble Grey ● 14

RAL colors



* Original product colors may vary from those illustrated.

Create my unique code!

5101 - ■ - 2 - ▲ - ● - ◆ - 00 - 2 - 00



CMS LAW FIRM TRZOP ARCHITEKCI

Long A

Long B

Wide A

Wide B

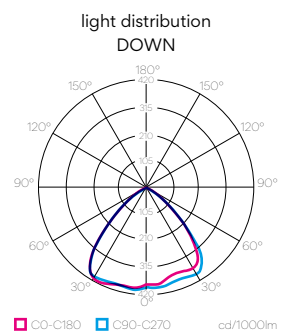
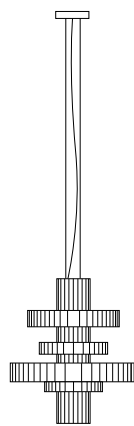
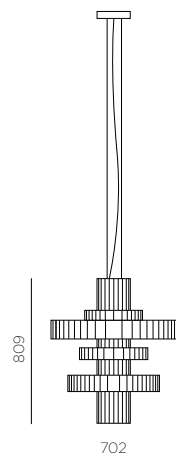
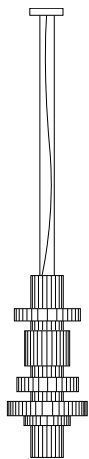
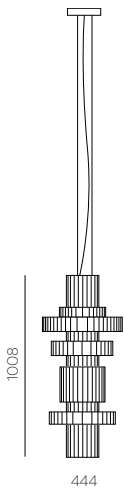

Boya





reddot winner 2021



Boya is a decorative hanging fitting. It may function as a single piece, but multiplied creates a pleasing collection. It is an exquisite mix of traditional handcraft and cutting-edge technology. When placed in the interior, it becomes its centerpiece, bringing a new level of elegance. Its light is soft and atmospheric, perfect for cosy spaces such as chill and lounge rooms.

The hanging system was designed to give the architects the freedom to compose it in dynamic arrangements, and nonchalant wiring gives it a playful character.

The warmth of the diffused light sets a calming, inviting mood to any space where the lamp is located.





MILKY



reddot winner 2021

Boya



SETTA



DARK

Shade finishings

Boya comes in 3 diverse shade finishings



Boya



reddot winner 2021

EN Boya is a decorative pendant luminaire. It can be used as a single element or, when hung in a cluster, it can create an interesting constellation. It is a combination of handicraft and state-of-the-art technologies. The lamp shade is made in the traditional blown-glass technology. The suspended system is designed to give you the freedom to compose it in dynamic arrangements, while the nonchalant cabling adds to its character. The color of the glass and the cable wrap can be customized.

Boya was awarded the prestigious Red Dot Award 2021.

DE Boya ist eine dekorative Hängelampe. Sie kann einzeln oder als interessantes Ensemble in mehrfacher Ausführung verwendet werden. Eine Kombination von Handwerk und modernster Technologie. Der Lampenschirm wird in traditioneller Technik aus geblasenem Glas hergestellt. Das Hängesystem ist so konzipiert, dass es die Möglichkeit bietet, die Lampe in dynamischen Arrangements zu komponieren, und die nonchalante Verkabelung trägt zu ihrem Charakter bei. Bei dieser Lampe können die Glasfarbe und das Kabelgeflecht farblich personalisiert werden.

Die Boya-Lampe erhielt die prestigeträchtige Red Dot Award 2021.

Example

Boya	standard power	4000K	no frame	no textil
↑	↑	↑	↑	↑
5102	- 02	- 2	- 8	- 4
		- 07	- 00	- 2
			- 00	- 00
	↓	↓	↓	↓
	Long wire	DALI	luminaire dark	pendant

Quickinfo

Boya A	■ 01
Boya B	■ 02
Boya C	■ 03
Boya D	■ 04

luminaire size	600×174
light source size	600×130
system power	↓↑20W
luminous flux	↓↑923lm
standard cable length	up to 2 meters

Technical information

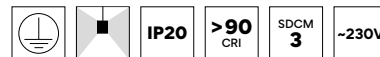

light distribution - up	180°
light distribution - down	180°
luminous efficiency	47lm/W
electrical control	ON / OFF ▲ 9
	DALI ▲ 8
color temperature	3000K ● 3
	4000K ● 4
luminaire color	milky ◆ 05
	setta ◆ 06
	dark ◆ 07

Create my unique code!

5102 - ■ - 2 - ▲ - ● - ◆ - 00 - 2 - 00

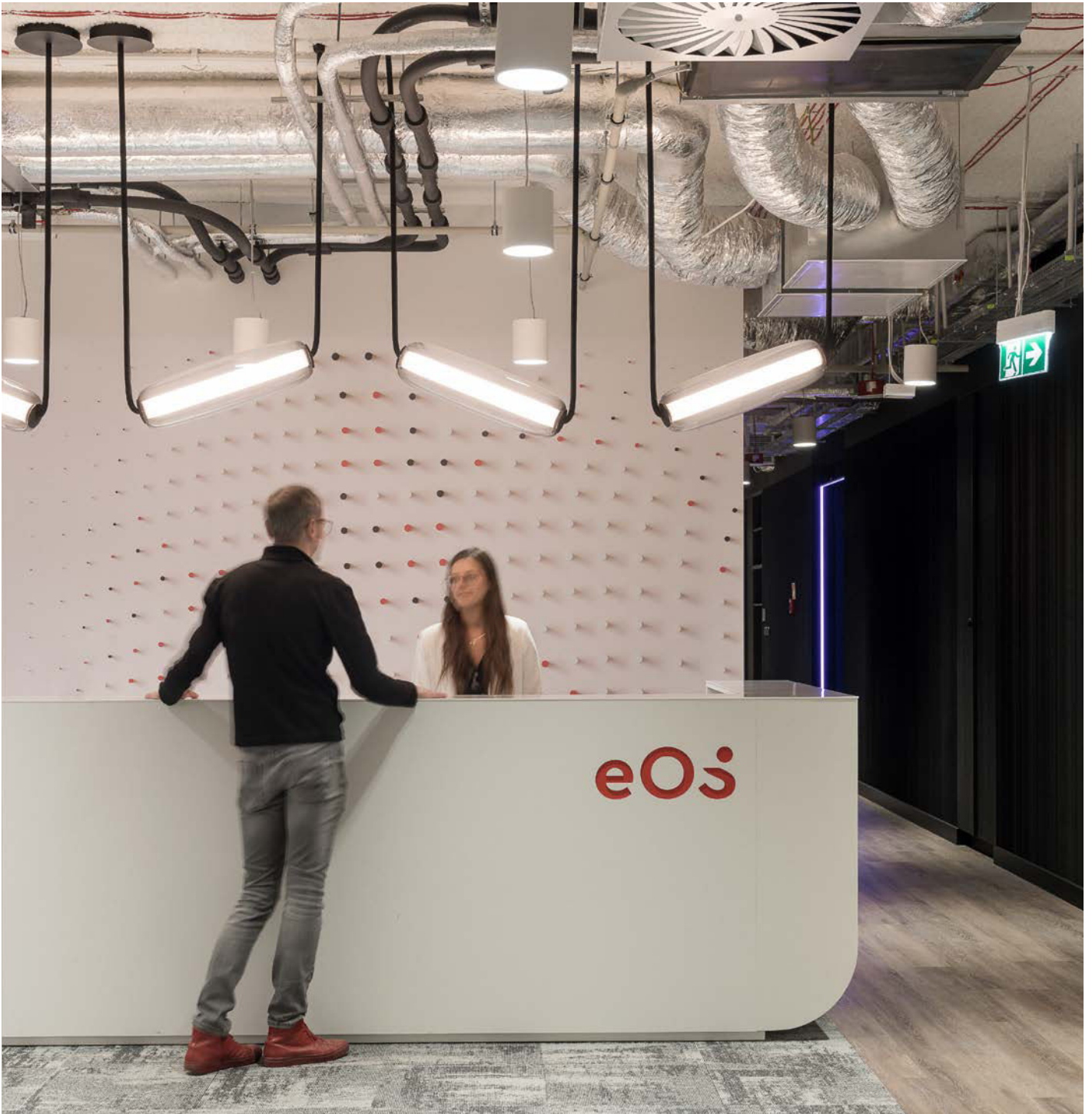

EOS POLAND TRZOP ARCHITEKCI

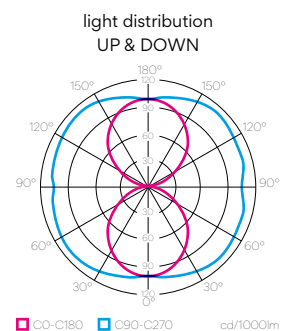
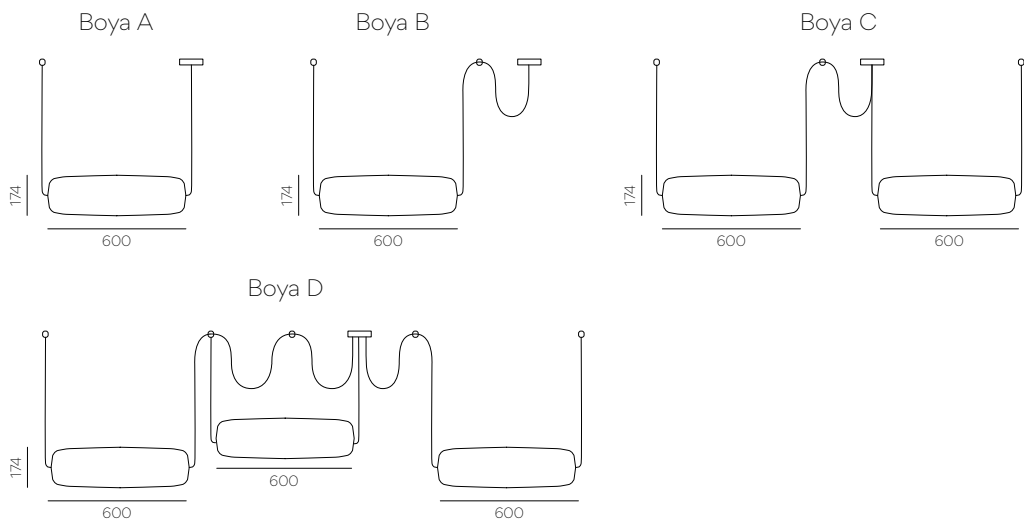

Jungle







Jungle



EN This decorative lamp invites more nature into the interior, which is the primary goal of the biophilic design trend. It can be used both as a lamp and a plant pot. The simple form of the luminous vessel provides the perfect background to emphasise the beauty of the plant. The lamp emits a soft, silky-smooth light that creates a relaxing ambiance, perfect for such areas as chill-out zones. The luminaire is suspended on two bands of fabric, available in a wide range of colors. The rotomoulded lampshade makes the lamp completely waterproof.

The Jungle lamp was awarded with Gold at the German Design Award 2022.

DE Dekorative Lampe, die einen Hauch von freier Natur in den Raum bringt, was das Hauptziel des Biophilic Design-Trends ist. Lampe und Blumentopf in einem. Die schlichte Form des leuchtenden Gefäßes ist ein perfekter Hintergrund, der die Pracht der Pflanze betont. Die Lampe strahlt ein weiches, seidenweiches Licht aus, das eine entspannende Atmosphäre schafft – die ideale Lösung für Orte wie die Chill-out-Zone. Die Leuchte ist an zwei Stoffstreifen aufgehängt, die in verschiedenen Farben bestellbar sind. Der rotationsgeformte Schirm macht die Lampe rundum wasserdicht.

Die Jungle Leuchte wurde beim German Design Award 2022 mit Gold ausgezeichnet.

Example

Jungle	standard power	4000K	no frame	grey stripes
↑	↑	↑	↑	↑
5103	- 30	- 2	- 8	- 4
	- 02	- 00	- 2	- J2544
	↓	↓	↓	↓
	bands	DALI	luminaire	pendant
	300 cm		white	

Quickinfo

100 cm	■ 10
150 cm	■ 15
200 cm	■ 20
250 cm	■ 25
300 cm	■ 30

luminaire size	Ø400×400
system power	↓38W
luminous flux	↓3251lm

Technical information

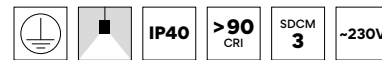

light distribution – down	240°
luminous efficiency	85lm/W
electrical control	ON / OFF ▲ 9
	DALI ▲ 8
color temperature	3000K ● 3
	4000K ● 4
luminaire color	white
fabric color	Dark Grey 2543 ◆ J2543
	Grey 2544 ◆ J2544
	Light Grey 2545 ◆ J2545
	Beige 2532 ◆ J2532
	Dark Blue 2554 ◆ J2554

Stripes colors

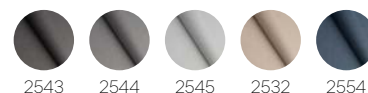

* Original product colors may vary from those illustrated.

Create my unique code!

5103 - ■ - 2 - ▲ - ● - 02 - 00 - 2 - ◆



PKO BP TRZOP ARCHITEKCI (press materials of PKO Bank Polski)

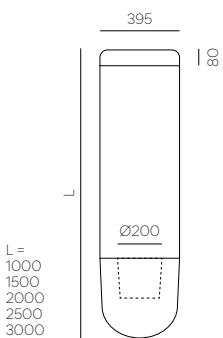

L =
1000
1500
2000
2500
3000

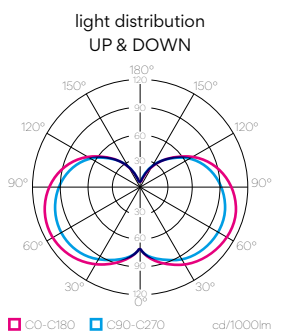
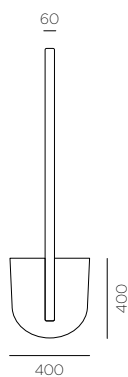

Blanket

Original lamp form resembles weaved fabric, but magnified to gigantic scale. Fabric's "warp" is made of bent aluminium tubes, and "weft" is made from thick, foam enhanced wool.

It's oversized structure was chosen specifically to divide space optically and acoustically. Areas divided by the lamp are not closed off completely, space can be sensibly manipulated, giving more privacy where it's needed.



Metal used for construction can be completely recycled. The fitting comes preassembled, despite its large size, it is flat, which makes it easy to stack during transport. The packaging is made of cardboard, and can be completely recycled.



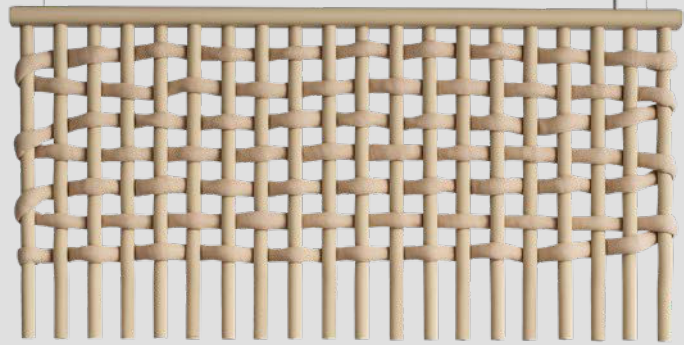
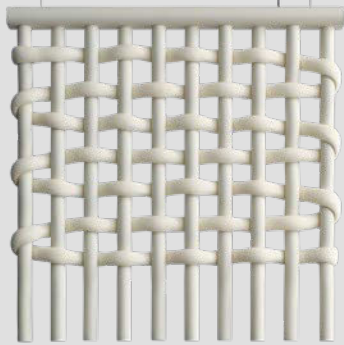

Blanket

must
have

EN The lamp resembles fabric in texture but it has been enlarged to a giant scale. The “warp” is made of folded aluminum tubes and the “weft” is made of thick wool fortified with foam. This over-scaled lighting design has been specially chosen to allow for the division of optical and acoustic space. At the same time, it does not close the space completely, because it is openwork. When dimmed, it can be used to provide mood lighting in spaces for relaxing.

DE Die Lampe erinnert in ihrer Struktur an Gewebe, jedoch in einen gigantischem Maßstab vergrößert. Der „Kettfaden“ des Gewebes besteht aus gebogenen Aluminiumrohren und der „Schuss“ aus dicker, mit Schaumstoff angereicherter Wolle. Diese maßstabgetreue Beleuchtungsstruktur wurde gezielt gewählt, um eine optische und akustische Teilung des Raumes zu ermöglichen. Gleichzeitig verschließt sie ihn nicht vollständig, da sie durchbrochen ist. Gedimmt kann sie als Stimmungslicht in Chill Out-Zonen eingesetzt werden.

Example

Blanket	standard power	3000 K	no frame	no textil
↑	↑	↑	↑	↑
5104	- 02	- 2	- 8	- 3
		- 11	- 00	- 2
			- 00	
	↓	↓	↓	↓
	size M	DALI	luminaire Beige Red RAL 3012	pendant

Quickinfo

	M	■ 02	XL	■ 04
luminaire size	M 590×590		XL 1195×590	
system power	↓12.5W - 10 × ↓1W		↓25W - 20 × ↓1W	
luminous flux	↓950lm		↓1900lm	
UGR	<19		<19	

Technical information

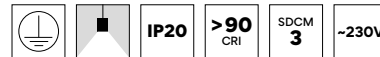

light distribution – down	30°
luminous efficiency	76lm/W
electrical control	ON/OFF ▲ 9 DALI ▲ 8
color temperature	3000K ● 3 5000K ● 5
luminaire color	RAL 3012 Beige Red ● 11 RAL 7015 Slate Grey ● 20 RAL 7046 Telegrey 2 ● 21 RAL 9001 Cream ● 22 RAL 1002 Sand Yellow ● 23 RAL 8004 Copper Brown ● 24

RAL colors

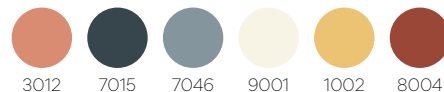

* Original product colors may vary from those illustrated.

Create my unique code!

5104 - ■ - 2 - ▲ - ● - ◆ - 00 - 2 - 00



M

XL

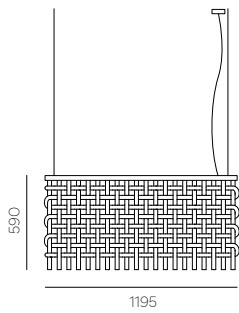
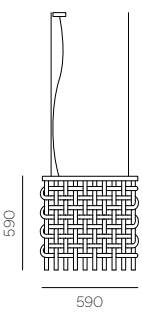

Team System





reddot winner 2021
best of the best

Acoustic Team is a system of four lamps with decorative accent lighting.

Its form enriches the interior by creating a cosy atmosphere, different forms and colors may be mixed together to create an eye-catching composition.

The fitting is perfect for spaces that will be enhanced by a piece that has a strong presence, and accentuates the mood with decorative light.



Configuration manual

These 3 segments allow to create various combinations adjusting it to our space.

 connector set

Create my unique code!

1062 - 05 - 2 - ▲ - ● - ◆ - 00 - 2 - ◆

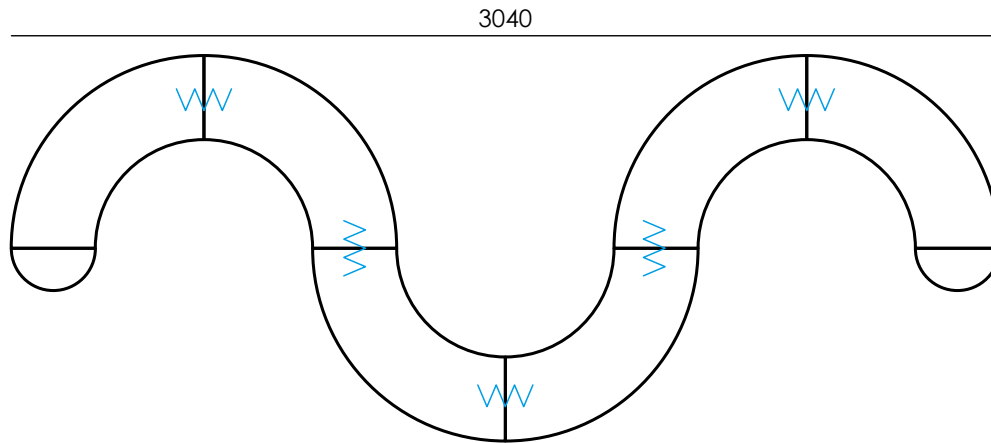

Create my unique code!

1032 - 02 - 2 - ▲ - ● - ◆ - 00 - 2 - ◆

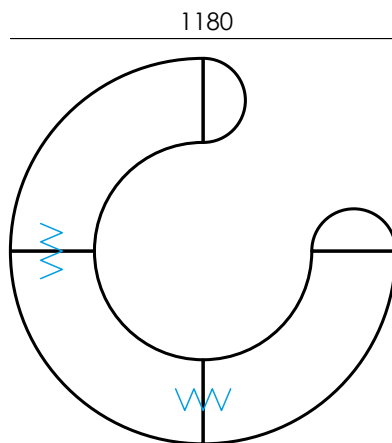

Create my unique code!

1040 - 04 - 2 - ▲ - ● - ◆ - 00 - 2 - ◆

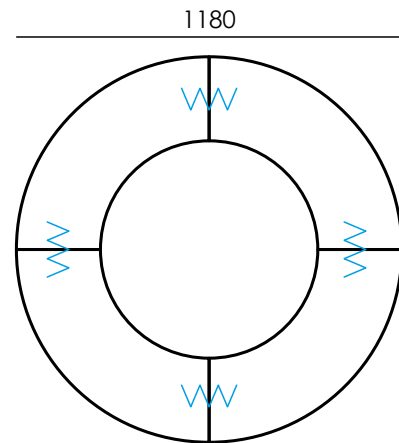

Create my unique code!

1240 - 06 - 2 - ▲ - ● - ◆ - 00 - 2 - ◆

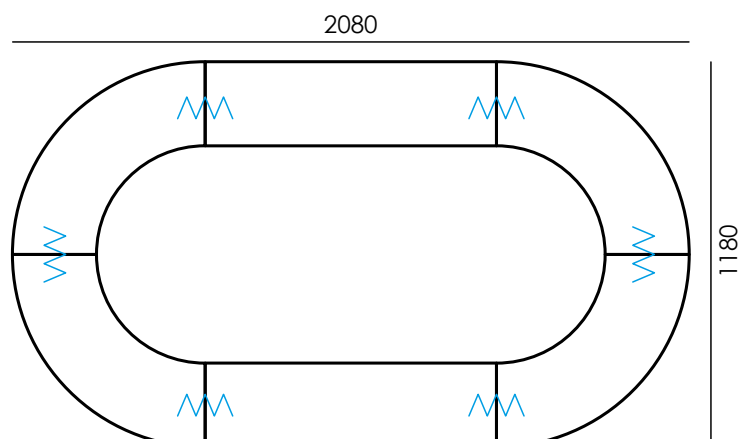

Create my unique code!

1022 - 01 - 2 - ▲ - ● - ◆ - 00 - 2 - ◆

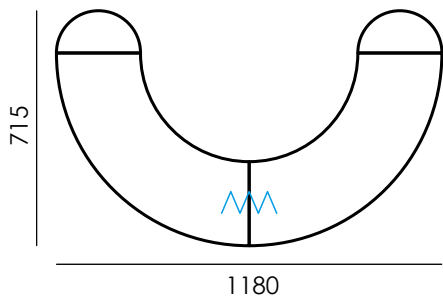

Create my unique code!

1142 - 04 - 2 - ▲ - ● - ◆ - 00 - 2 - ◆

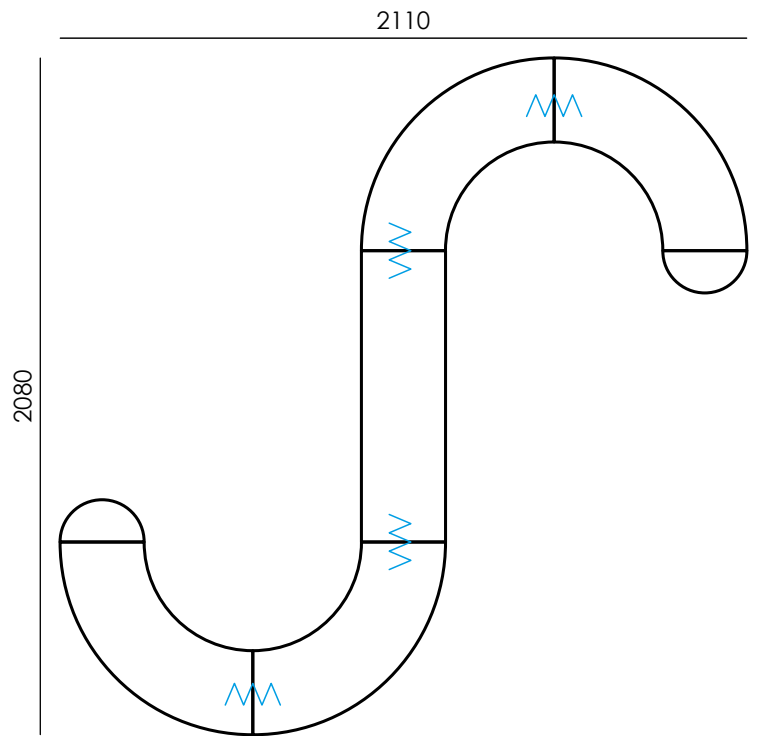

Create my unique code!

1102 - 00 - 2 - ▲ - ● - ◆ - 00 - 2 - ◆

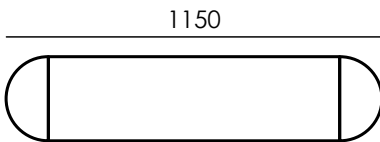

Create my unique code!

1102 - 01 - 2 - ▲ - ● - ◆ - 00 - 2 - ◆

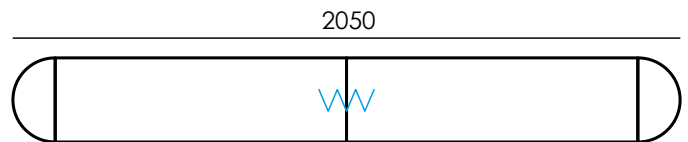

Create my unique code!

1302 - 02 - 2 - ▲ - ● - ◆ - 00 - 2 - ◆

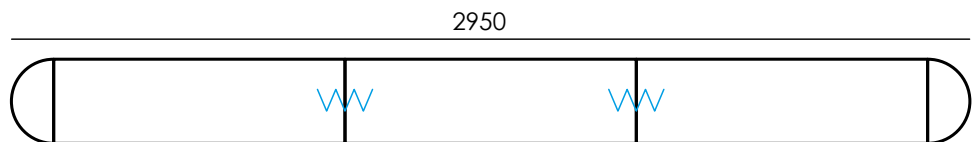

Create my unique code!

1402 - 03 - 2 - ▲ - ● - ◆ - 00 - 2 - ◆

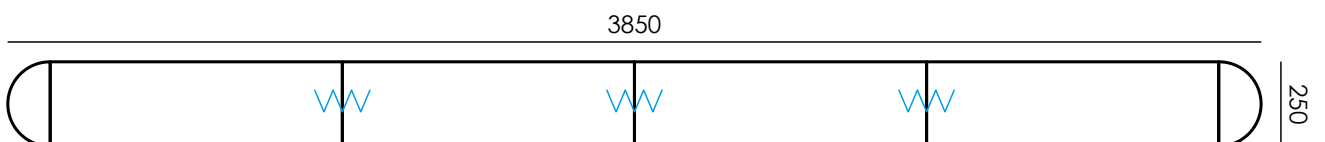



Team System



reddot winner 2021
best of the best

EN A modular lamp made of three different components that can be combined in different ways. Thanks to the domed shade and the pressed fabric, the lamp absorbs some of the ambient sound. These features make it perfect for office environments, such as open-plan offices. Thanks to its excellent design, it creates a warm atmosphere in any interior. Recycled plastic bottles have been used to make the shade. The luminaire is available in two lighting options – for ambient lighting and for work. The color of the shade can be customized.

The lamp was awarded the Red Dot Award: Best of the Best 2021, designed by Kabo & Pydo – Design Studio.

DE Modullampe mit drei verschiedenen Elementen, die beliebig kombiniert werden können. Die Kuppelform des Lampenschirms und das gepresste Material sorgen dafür, dass die Lampe einen Teil der Umgebungsgeräusche absorbiert. Deshalb eignet sich das Modell perfekt für Büroarbeitsplätze, wie etwa in Open Space-Büros. Dank des ausgezeichneten Designs bringt sie eine warme Stimmung in den Raum. Bei der Herstellung des Lampenschirms wurden recycelte Plastikflaschen verarbeitet. Die Lampe ist in zwei Beleuchtungsvarianten erhältlich – als Deko-Leuchte und zur Arbeit. Möglichkeit zur Personalisierung der Farbe des Lampenschirms.

Die Lampe wurde mit der Auszeichnung Red Dot: Best of the Best 2021 ausgezeichnet, Entw. Kabo & Pydo – Design Studio.

Example

Team round shape	standard power	3000 K	no frame	antrazit color
↑	↑	↑	↑	↑
1040	- 04	- 2	- 8	- 3
				- 01
				- 00
				- 2
				- TAN
	↓	↓	↓	↓
	4 connector sets	DALI	luminaire black 9005	pendant

Quickinfo

code	Straight	100	Arc	010	End	001
connector sets	one set two sets three sets x sets	■ 01 ■ 02 ■ 03 ■ xx	one set two sets three sets x sets	■ 01 ■ 02 ■ 03 ■ xx		
luminaire size	900×250		590×590		125×250	
light source size	900		900			
system power	↓24W		↓18W			
luminous flux	↓2700lm		↓2100lm			
UGR	<19		<19			
luminous efficiency	112lm/W		116lm/W			

Technical information

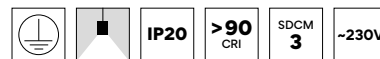

light distribution – down	60°	
electrical control	ON / OFF	▲ 9
	DALI	▲ 8
color temperature	3000K	● 3
	4000K	● 4
luminaire color	black 9005	◆ 01
	white 9010	◆ 02
	on request: RAL color palette	◆ 99
fabric color	Antrazit	◆ TAN
	Light Grey	◆ TLG
	Blue	◆ TBL
	Green	◆ TGR
	Coral	◆ TCO

Available colors

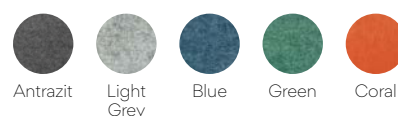

* Original product colors may vary from those illustrated.



BAT DBS THE DESIGN GROUP

straight

arc

end

100

010

001

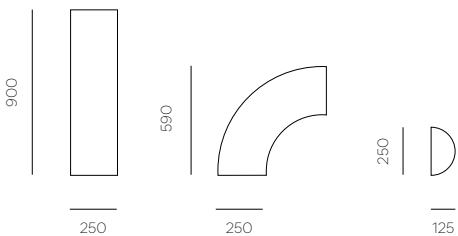



Ribbon

EN The luminaires from this line were inspired by classic, woven lampshades. Due to its size, each of luminaires creates an intimate space. The lamp is filigree in details and vast in size. The luminaire is based on two shades, external and internal. The whole is based on a welded structure made of powder-coated steel rods. Customers can choose from a luminaire in the shape of a circle or a rectangle with rounded corners.

DE Inspiration für die Leuchten dieser Linie waren klassische, gewebte Lampenschirme. Jede der Leuchten definiert aufgrund ihrer Größe einen intimen Raum. Die Leuchte ist filigran im Detail und maßgebend in der Größe. Die Leuchte basiert auf zwei Lampenschirmen – einem äußeren und einem inneren. Das Ganze basiert auf einer Schweißkonstruktion aus pulverbeschichteten Stahlstäben. Kunden können eine Leuchte auf Basis eines Kreises oder eines Rechtecks mit abgerundeten Ecken wählen.

Ribbon color palette

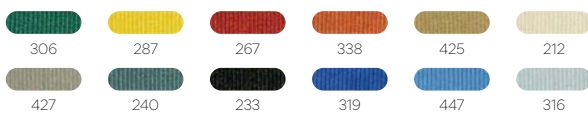

* Original product colors may vary from those illustrated.

Example

Ribbon	standard power	3000 K	black 9005 frame	color R306
↑	↑	↑	↑	↑
5105	- 04	- 2	- 8	- 3
		- 01	- 01	- 2
				- R306
	↓	↓	↓	↓
	size XL	DALI	luminaire black 7021	pendant

Quickinfo

	XL	■ 04	XXL	■ 05
luminaire size	Ø1100×245		2045×1100×245	
light source size	Ø450×82		2 × Ø450×82	
system power	30W (↑9W ↓21W)		2 × 30W (↑9W ↓21W)	
luminous flux	↑1000lm ↓2100lm		2 × ↑1000lm ↓2100lm	

Technical information

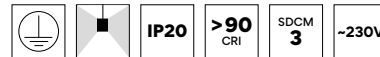

UGR	<18
light distribution - up	100°
light distribution - down	95°
luminous efficiency	110lm/W
electrical control	ON / OFF ▲ 9 DALI ▲ 8
color temperature	3000K ● 3 4000K ● 4
luminaire color	black 7021 ● 01 white 9003 ● 02
frame color	black 9005 * 01 white 9010 * 02
fabric color	Ribbon 306 ◆ R306 Ribbon 287 ◆ R287 Ribbon 267 ◆ R267 Ribbon 338 ◆ R338 Ribbon 425 ◆ R425 Ribbon 212 ◆ R212 Ribbon 427 ◆ R427 Ribbon 240 ◆ R240 Ribbon 446 ◆ R446 Ribbon 319 ◆ R319 Ribbon 447 ◆ R447 Ribbon 316 ◆ R316

Create my unique code!

5105 - ■ - 2 - ▲ - ● - ◆ - * - 2 - ◆



STADA THE DESIGN GROUP

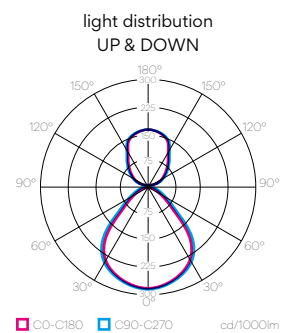
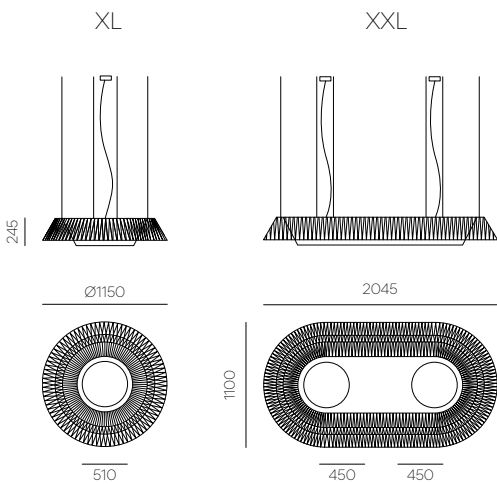



Reloft

EN The industrial lamp by Mesko from the 1970s renovated to both provide light for office spaces and serve as a decorative interior element. The lamp shade has been sandblasted and repainted, which gives it more character without damaging the original form. A microprism diffuser has been added to the bottom to provide comfortable lighting.

Bring a loft feel to your design with our lamp.

DE Industrielampe der Firma Mesko aus den 1970er Jahren, die nach der Restaurierung sowohl Büroräume beleuchten, als auch als Deko-Lampe eingesetzt werden kann. Der Lampenschirm wurde sandgestrahlt und neu lackiert, was der Lampe Charakter verleiht, ohne die ursprüngliche Form zu zerstören. An der Unterseite wurde eine mikroprismatische Blende angebracht, um eine komfortable Beleuchtung zu gewährleisten.

Verleihen Sie Ihrem Projekt dank unserer Lampe echtes Loft-Flair.

Example

Reloft	standard power	3000 K	no frame	no textil
↑	↑	↑	↑	↑
5106 - 00 - 2 - 8 - 3 - 01 - 00 - 2 - 00				
↓	↓	↓	↓	↓
one size	DALI	luminaire black 9005	pendant	

Quickinfo

luminaire size	600×430×420
system power	↓44W
luminous flux	↓5000lm
UGR	<19

Technical information

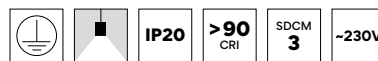

light distribution - down	60°
luminous efficiency	113lm/W
electrical control	ON / OFF ▲ 9
	DALI ▲ 8
color temperature	3000K ● 3
	4000K ● 4
luminaire color	black 9005 ◆ 01
	on request: RAL color palette ◆ 99

Create my unique code!

5106 - 00 - 2 - ▲ - ● - ◆ - 00 - 2 - 00



ERGO TRZOP ARCHITEKCI

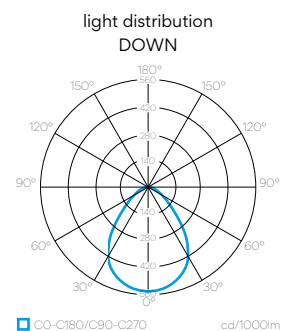
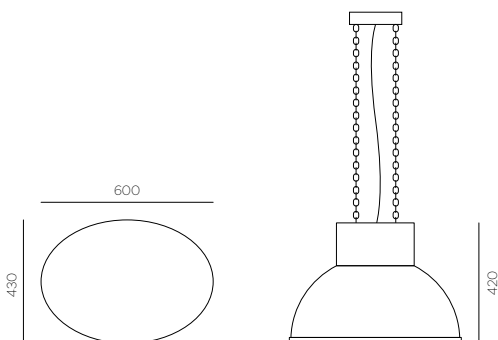



Loft One

EN This minimalist pendant light in a contemporary, loft style features a single COB light source. The simple industrial form is perfect for both public and private spaces. The high quality workmanship and attention to detail will satisfy the most demanding customer. In addition, you can choose the color of the luminaire and the wire, the light color and the power supply method.

DE Minimalistische Hängelampe im modernen Loft-Stil, mit einer einzigen COB-Lichtquelle. Die schlichte industrielle Form ist sowohl für öffentliche Räumlichkeiten als auch für Privaträume ideal geeignet. Die hochwertige Ausführung und Liebe zum Detail stellen auch anspruchsvollste Kunden zufrieden. Zusätzlich besteht die Möglichkeit, die Farbe von Gehäuse und Kabel sowie die Lichtfarbe und die Energiequelle zu wählen.

Example

Loft one	standard power	3000 K	no frame	no textil
↑	↑	↑	↑	↑
5107 - 00	- 2	- 8	- 3	- 01
	- 00	- 00	- 2	- 00
↓	↓	↓	↓	↓
one size	DALI	luminaire black 9005	pendant	

Quickinfo

luminaire size	Ø490×350
system power	↓32W
luminous flux	↓3175lm
UGR	<19

Technical information

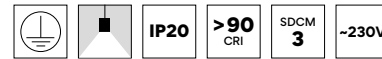

light distribution - down	60°	
luminous efficiency	99lm/W	
electrical control	ON / OFF	▲ 9
	DALI	▲ 8
color temperature	3000K	● 3
	4000K	● 4
luminaire color	black 9005	◆ 01
	on request: RAL color palette	◆ 99

Create my unique code!

5107 - 00 - 2 - ▲ - ● - ◆ - 00 - 2 - 00

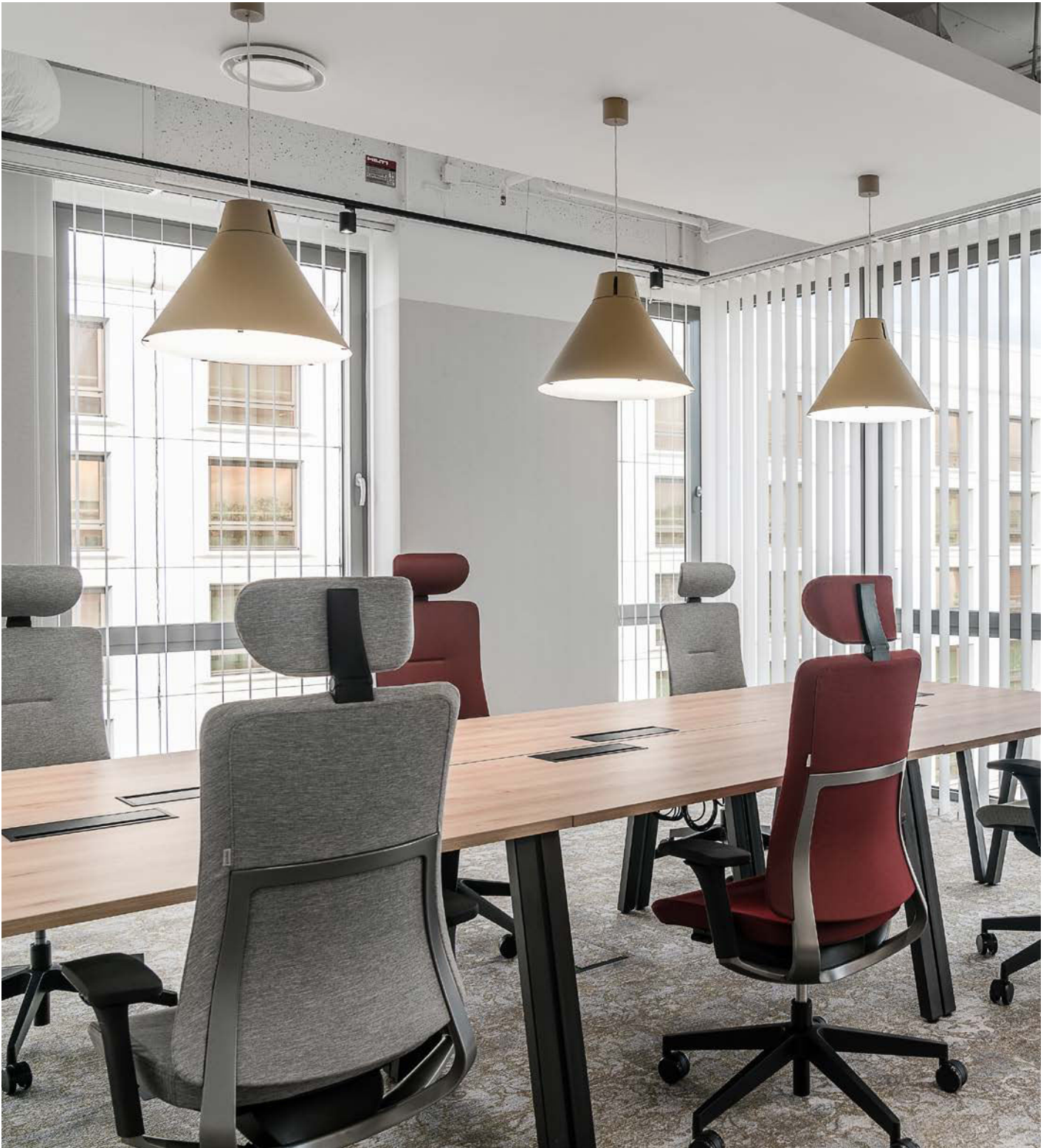

SOLUTIONS RENT COWORKING THE DESIGN GROUP

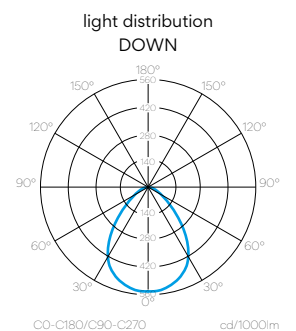
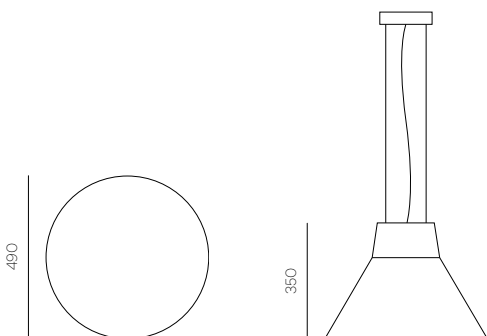



Urban

EN Industrial linear lamp made of stainless steel, mounted to the ceiling with cables as a pendant lamp. Urban features an attractive design, quick assembly and a low glare value of UGR<19. As an option, it can be controlled with the DALI control system. Made from high quality components from the best European manufacturers. The unique loft design and attention to detail will satisfy the most demanding customers. The product is perfect for offices, conference rooms, and passageways.

DE Industrielle Langfeldleuchte aus Edelstahl, mit Drähten als Pendelleuchte an der Decke montiert. Urban zeichnet sich durch das ästhetische Design, die schnelle Montage und eine geringe Blendung UGR<19 aus. Optionale DALI-Steuerung. Hergestellt aus hochwertigen Komponenten von besten europäischen Herstellern. Das einzigartige Loft-Design und die Liebe zum Detail stellen auch die anspruchsvollsten Kunden zufrieden. Das Produkt eignet sich perfekt für Büroräume, Konferenzsäle und Flure.

Example

Urban	standard power	3000 K	no frame	no textil
↑	↑	↑	↑	↑
5108 - 00 - 2 - 8 - 3 - 20 - 00 - 2 - 00				
↓	↓	↓	↓	↓
one size	DALI	luminaire inox	pendant	

Quickinfo

luminaire size	1300×90×140
system power	↓27W
luminous flux	↓2564lm
UGR	<19

Technical information



light distribution – down	60°
luminous efficiency	97lm/W
electrical control	ON/OFF ▲ 9 DALI ▲ 8
color temperature	3000K ● 3 4000K ● 4
luminaire color	inox

Create my unique code!

5108 - 00 - 2 - ▲ - ● - 20 - 00 - 2 - 00

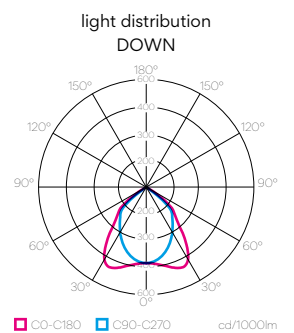
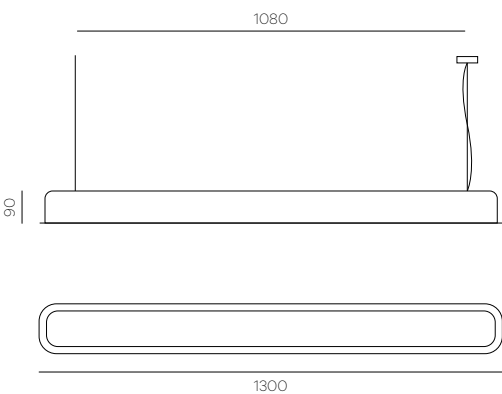

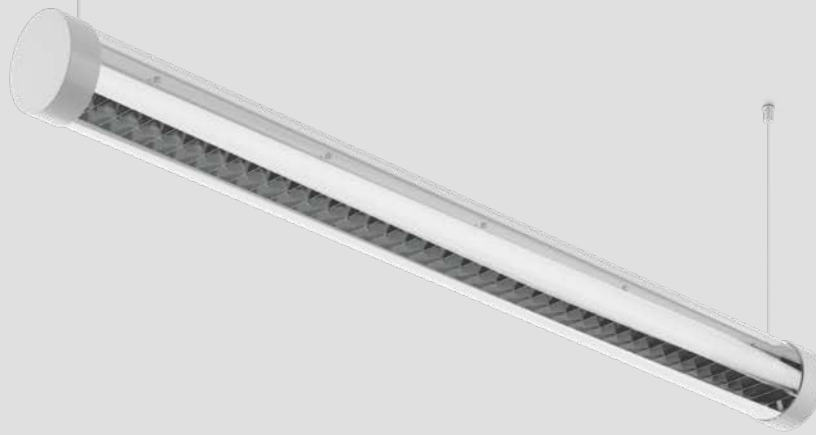

Tube

EN The modern Tube luminaire with a unique design. The shape of a transparent tube with visible technical elements gives it an industrial, loft appearance. It is characterized by high quality workmanship, the best components of European production, easy assembly and interesting design. Perfect for indoor use, especially in offices and public utility buildings.

DE Moderne Tube Leuchte mit einzigartiger Konstruktion. Die transparente Röhrenform mit sichtbaren technischen Elementen verleiht ihr einen industriellen, loftähnlichen Stil. Das Modell zeichnet sich durch hohe Ausführungsqualität, beste Komponenten europäischer Herstellung, die einfache Montage und ein interessantes Design aus. Die ideale Lösung für Innenräume und insbesondere für Büros und öffentliche Gebäude.

Example

Tube	standard power	3000 K	no frame	no textil
↑	↑	↑	↑	↑
5109 - 00	- 2	- 8	- 3	- 04
- 00	- 2	- 8	- 3	- 04
- 00	- 2	- 8	- 3	- 04
↓	↓	↓	↓	↓
one size	DALI	luminaire silver 9006	pendant	

Quickinfo

luminaire size	1260 × Ø105
system power	↓37W
luminous flux	↓3569lm
UGR	<19

Technical information

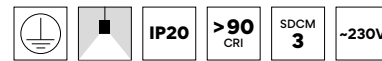

light distribution – down	70°
luminous efficiency	97lm/W
electrical control	ON / OFF ▲ 9
	DALI ▲ 8
color temperature	3000K ● 3
	4000K ● 4
luminaire color	silver 9006 ◆ 04
	on request: RAL color palette ◆ 99

Create my unique code!

5109 - 00 - 2 - ▲ - ● - ◆ - 00 - 2 - 00

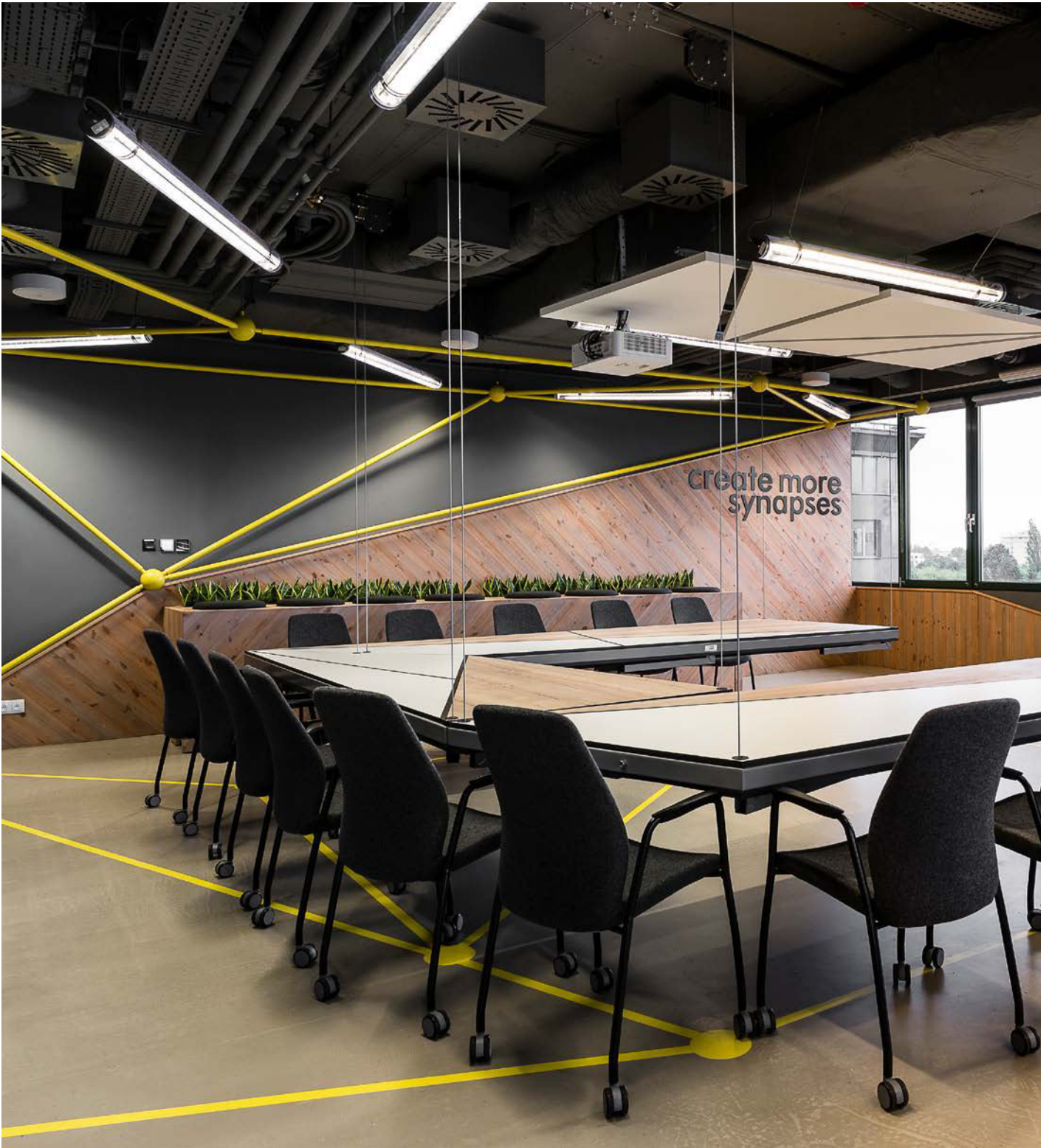

BRAIN EMBASSY MODE:LINA

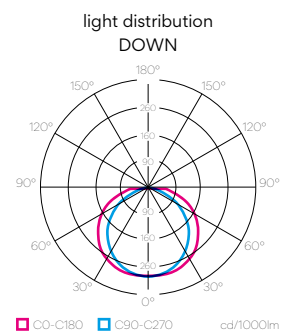
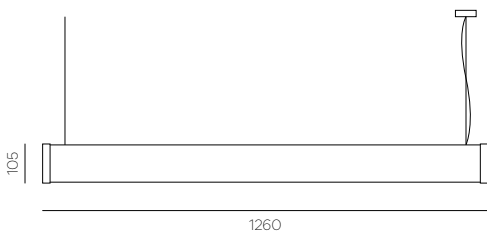

Professional

Professional

office



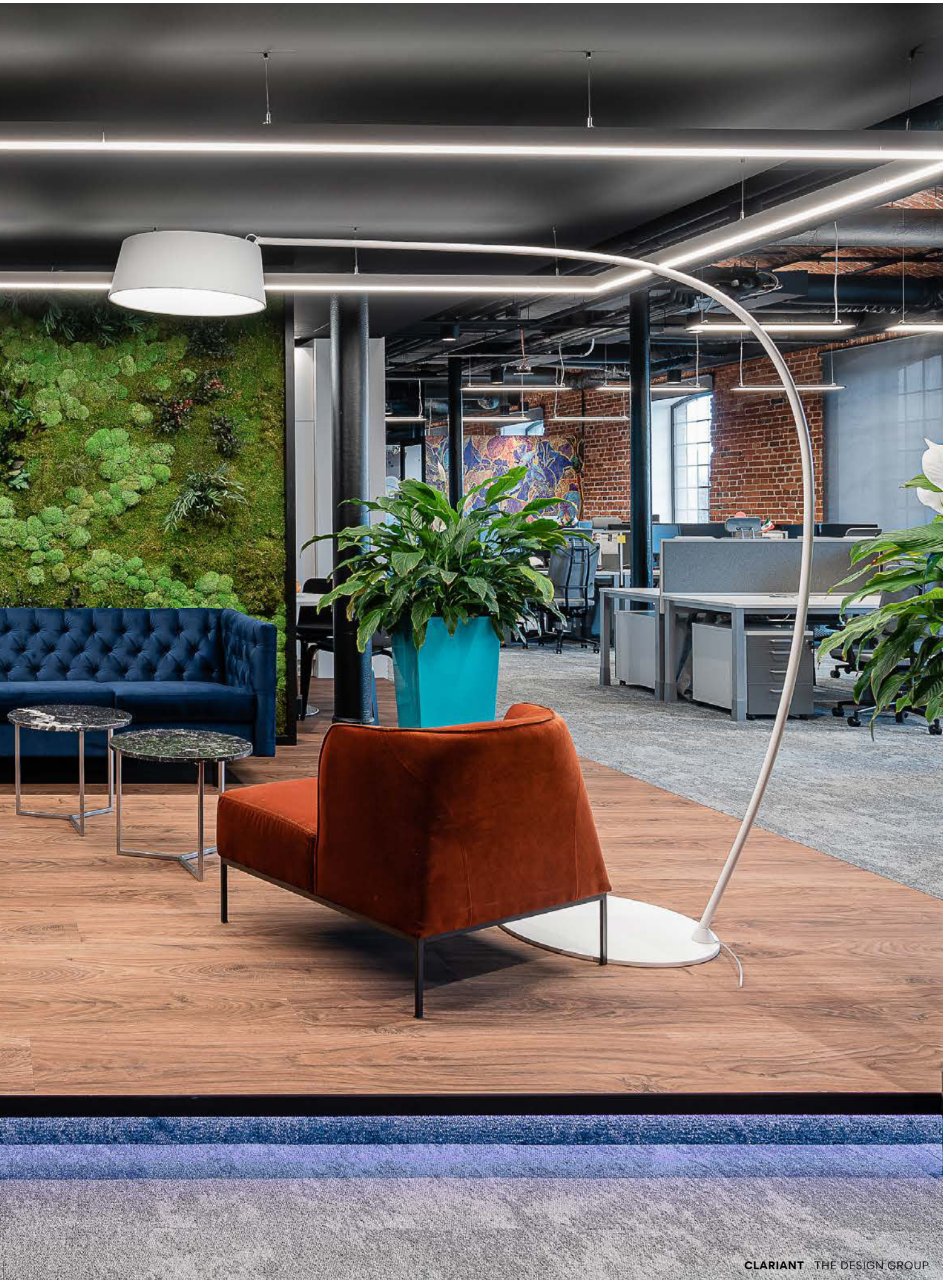

CLARIANT THE DESIGN GROUP

Line

The Flexxica Line series come with minimalist design, excellent material selection and production technology, exquisite appearance, and rich texture. Choose from various combinations of profile-type housing designs to make an attractive space where workers can communicate, work as a team and relax.

Need to take a closer look at our flexxica linear luminaires? Scan the QR code to view them all now!





XL CATLIN THE DESIGN GROUP

Line 43

One linear luminaire family, customizable to any office space. Line 43 is the most versatile range of our office lighting. Available in various forms, sizes, colors, and mounting options. It's the ideal linear for lighting specifiers and architects to mix and match – to create nearly limitless combinations for any application.

Personalize your Line 43 luminaire to suit your individual needs.

Choose the suitable optics:

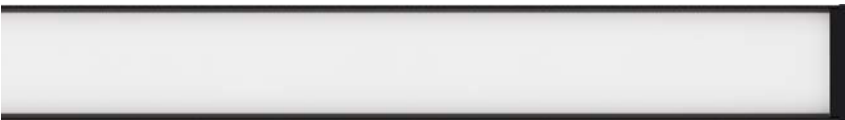

Opal Diffuser



Microprismatic
Diffuser



Dark Optic

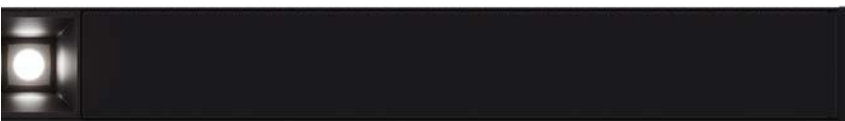

Blind Cover



Wall Washer

...and the reflector color
if your choice was Dark Optic:

Black matte



White matte



Silver matte



Gold matte





Line 43 Diffusers

EN Linear design luminaire made of an aluminum profile with a diameter of 43 mm and an LED light source merges high functionality with a simple design. Line 43 offers creative mounting options such as a pendant luminaire DOWN, pendant UP & DOWN or surface mounting. The diffuser achieves a uniform light distribution and is available in three output levels and color temperatures. The housing can be painted any color from the RAL palette. The high quality of craft and the excellent light characteristics of this lamp make it ideal for use in offices, shopping venues, galleries, and museums.

DE Lineare Designleuchte aus einem Aluminiumprofil mit einem Durchmesser von 43 mm und einer LED-Lichtquelle vereint hohe Funktionalität mit einem schlichten Design. Die Linie 43 bietet kreative Montagemöglichkeiten wie Pendelleuchte DOWN, Pendelleuchte UP & DOWN oder Anbaumontage. Der Diffusor sorgt für eine gleichmäßige Lichtverteilung und ist in drei Leistungsstufen und Farbtemperaturen erhältlich. Das Gehäuse kann in jeder Farbe der RAL-Palette lackiert werden. Die hohe handwerkliche Qualität und die exzellenten Lichteigenschaften dieser Leuchte machen sie ideal für den Einsatz in Büros, Einkaufszentren, Galerien und Museen.

Example

Line 43 Diffusers	opal	standard power	3000K	no reflector
↑	↑	↑	↑	↑
72	1	1 - 08 - 2 - 8 - 3 - 01 - 00		
↓	↓	↓	↓	↓
surface	size 576 mm	DALI	housing black 9005	

size		↓light	system power standard	luminous flux 4000K, opal
576 mm	■ 08	2 ft	↓9.8W	↓937lm
856 mm	■ 12	3 ft	↓14.7W	↓1406lm
1136 mm	■ 16	4 ft	↓19.6W	↓1874lm
1416 mm	■ 20	5 ft	↓24.5W	↓2343lm
1696 mm	■ 24	6 ft	↓29.4W	↓2811lm
1976 mm	■ 28	7 ft	↓34.3W	↓3280lm
2256 mm	■ 32	8 ft	↓39.2W	↓3748lm
2536 mm	■ 36	9 ft	↓44.1W	↓4217lm
2816 mm	■ 40	10 ft	↓49W	↓4686lm
3096 mm	■ 44	11 ft	↓53.9W	↓5154lm
3376 mm	■ 48	12 ft	↓58.8W	↓5622lm

Technical information



UGR	<19 / <25			
lighting power	low	~ 1		
	standard	~ 2		
	high	~ 3		
mounting type	surface	+ 1		
	pendant	+ 2		
	pendant up & down	+ 3		
light distribution - down	60° mpr			
	120° opal			
luminous efficiency	LO	ST	HI	
	mpr	94lm/W	90lm/W	86lm/W *
	opal	99lm/W	95lm/W	91lm/W *
electrical control	ON/OFF	▲ 9		
	DALI	▲ 8		
color temperature	3000K	● 3		
	4000K	● 4		
	on request: TUNABLE WHITE	● 9		
housing color	black 9005	◆ 01		
	white 9010	◆ 02		
	on request: RAL color palette	◆ 99		
optics	opal	□ 1		
	microprismatic	□ 2		
	blind cover	□ 9		

* Photometric data: 4 ft, 4000K, CRI 90

Create my unique code!

72+□ - ■ - ~ - ▲ - ● - ◆ - 00

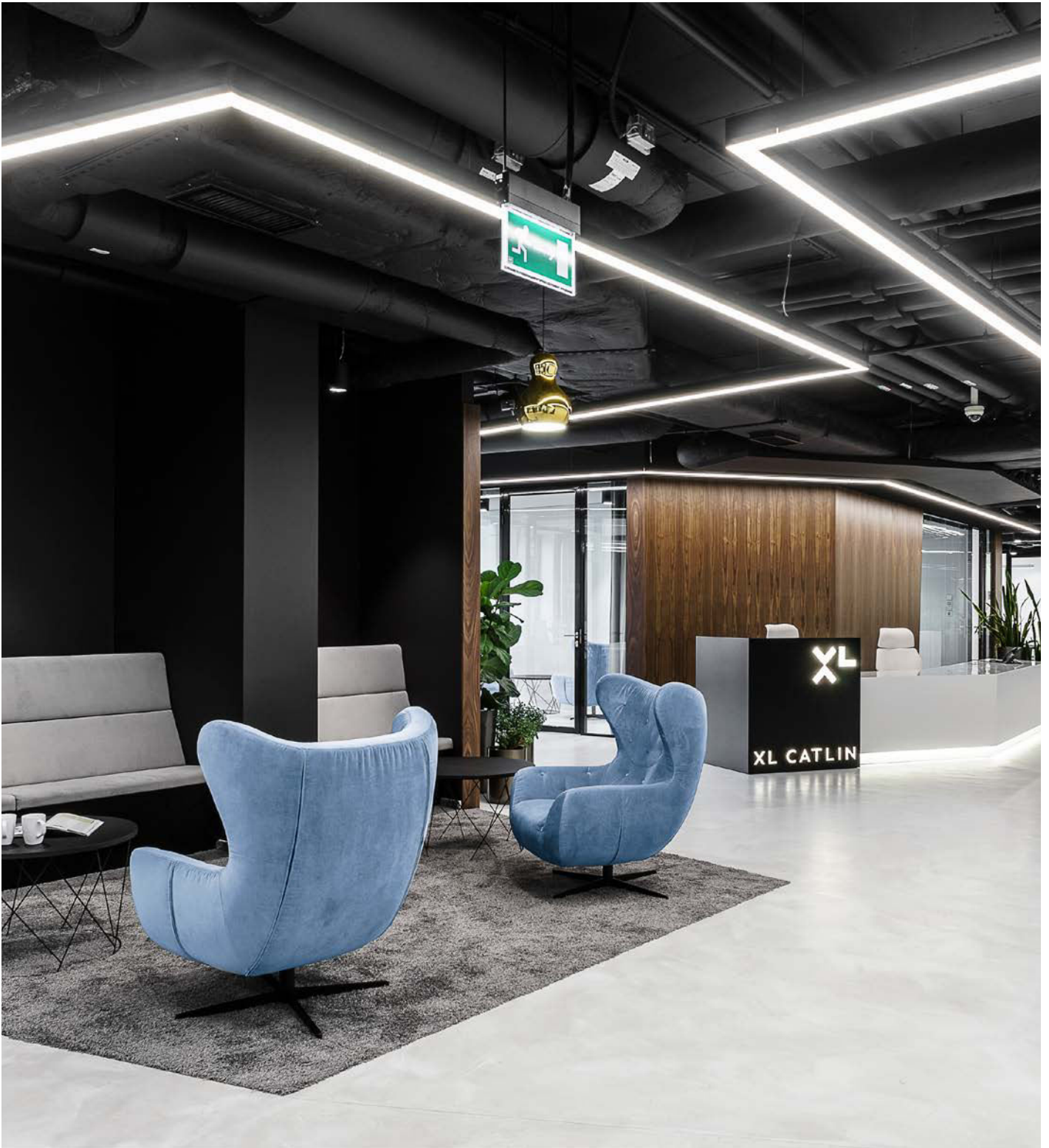

XL CATLIN THE DESIGN GROUP

Light distribution down:
A = min 2 ft, max 12 ft

Light distribution up:
B = A - 1 ft

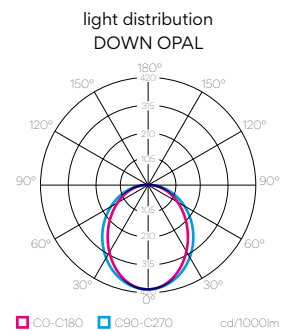
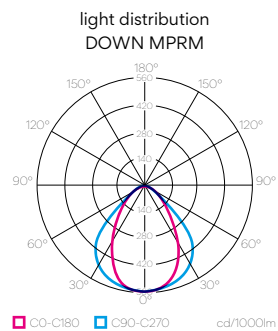
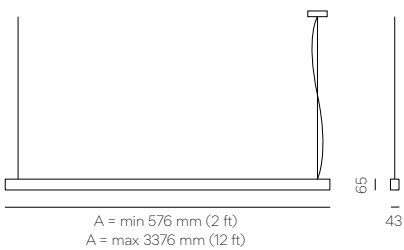



Line 43 Dark Optics

EN This Dark Optics 43 mm linear luminaire's design focuses on a highly effective optical system that provides glare-free direct and indirect light. Line 43 conveys a pleasing aesthetic balance while the colored lenses create attractive accents and a pleasant atmosphere. The luminaire has interchangeable black, white, silver, and gold reflectors. The construction of this profile-type of the luminaire allows the creation of a length of over three meters straight form. The high quality of craft and the excellent light characteristics of this lamp make it ideal for use in office spaces allowing the implementation of unique lighting concepts.

DE Das Design dieser Dark Optics 43 mm Langfeldleuchte konzentriert sich auf ein hocheffektives optisches System, das für blendfreies direktes und indirektes Licht sorgt. Line 43 vermittelt eine angenehme ästhetische Ausgewogenheit, während die farbigen Reflektoren attraktive Akzente und eine angenehme Atmosphäre schaffen. Die Leuchte hat austauschbare schwarze, weiße, silberne und goldene Reflektoren. Die Konstruktion dieses Profiltyps der Leuchte ermöglicht die Schaffung einer Länge von über drei Metern in gerader Form. Die hohe Verarbeitungsqualität und die hervorragenden Lichteigenschaften dieser Leuchte prädestinieren sie für den Einsatz in Büroräumen und ermöglichen die Umsetzung einzigartiger Beleuchtungskonzepte.

Create my unique code!

72+□ - ■ - ~ - ▲ - ○ - ♣ - *

Example

Line 43 Dark Optics	dark optic 80°	standard power	3000K	reflector black matte
↑	↑	↑	↑	↑
72	1	3 - 08	- 2 - 8	- 3 - 01 - 01
↓	↓	↓	↓	↓
surface	size 576 mm	DALI	housing black 9005	

size		↓light	system power standard	luminous flux 4000K, 80° white
576 mm	■ 08	2 ft	↓9.8W	↓1156lm
856 mm	■ 12	3 ft	↓14.7W	↓1734lm
1136 mm	■ 16	4 ft	↓19.6W	↓2312lm
1416 mm	■ 20	5 ft	↓24.5W	↓2890lm
1696 mm	■ 24	6 ft	↓29.4W	↓3468lm
1976 mm	■ 28	7 ft	↓34.3W	↓4046lm
2256 mm	■ 32	8 ft	↓39.2W	↓4624lm
2536 mm	■ 36	9 ft	↓44.1W	↓5202lm
2816 mm	■ 40	10 ft	↓49W	↓5780lm
3096 mm	■ 44	11 ft	↓53.9W	↓6358lm
3376 mm	■ 48	12 ft	↓58.8W	↓6936lm

Technical information



UGR	<19			
lighting power	low	~ 1		
	standard	~ 2		
	high	~ 3		
mounting type	surface	+ 1		
	pendant	+ 2		
	pendant up & down	+ 3		
light distribution - down	80° / 50° / 35° / wall washer			
luminous efficiency	LO	ST	HI	
	80°	123lm/W	117lm/W	112lm/W *
	50°	119lm/W	114lm/W	108lm/W *
electrical control	ON / OFF	▲ 9		
	DALI	▲ 8		
color temperature	3000K	● 3		
	4000K	● 4		
	on request: TUNABLE WHITE	● 9		
housing color	black 9005	♣ 01		
	white 9010	♣ 02		
	on request: RAL color palette	♣ 99		
reflector color	black matte	* 01		
	white matte	* 02		
	silver matte	* 04		
	on request: gold matte	* 05		
	blind cover	* 9		
dark optics	dark optic 80°	□ 3		
	dark optic 50°	□ 4		
	dark optic 35°	□ 5		
	wall washer	□ 7		
	blind cover	□ 9		

* Photometric data: 4 ft, 4000K, CRI 90, white reflector

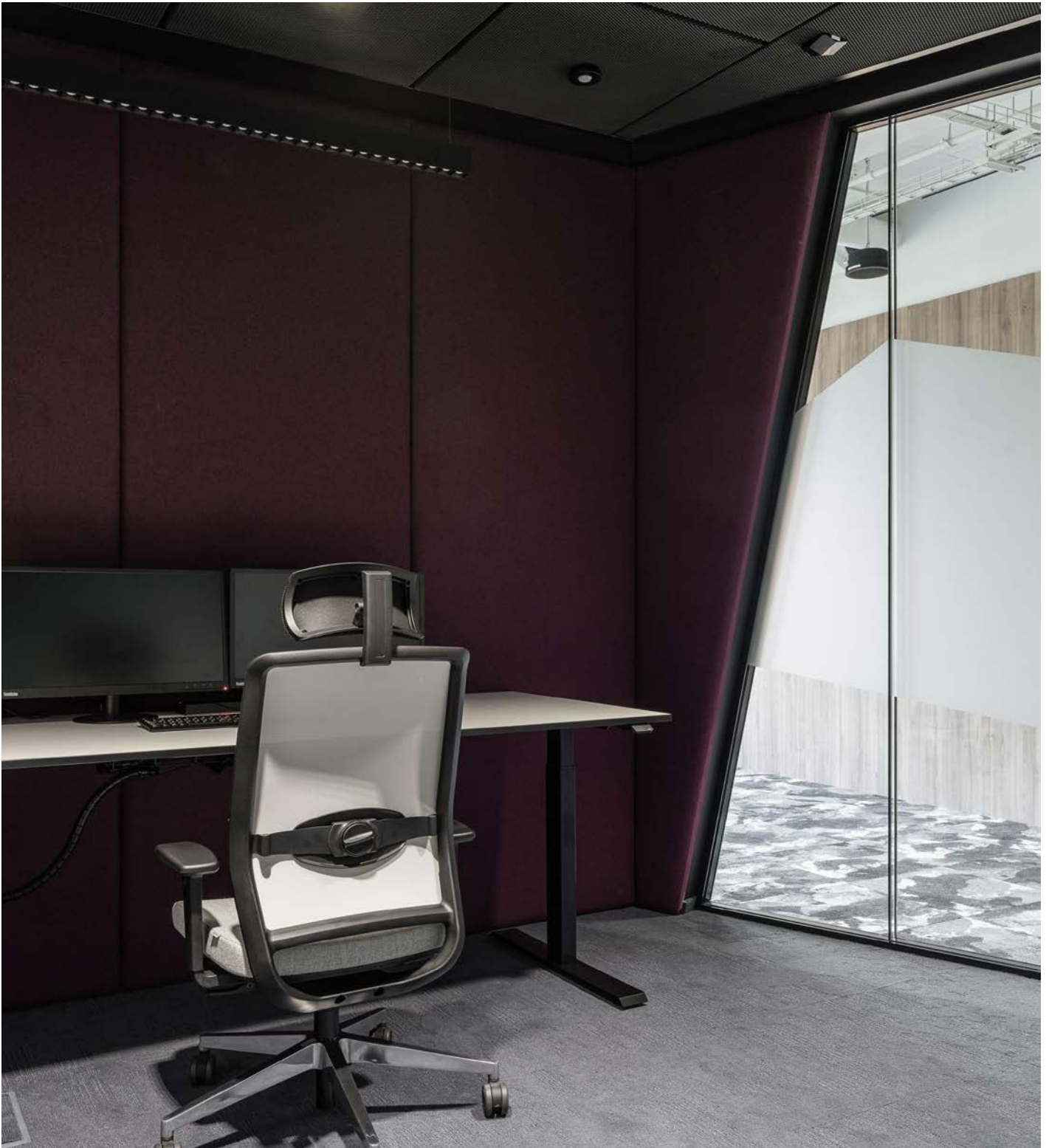

TECHNIP THE DESIGN GROUP

Light distribution down:
A = min 2 ft, max 12 ft

Light distribution up:
B = A - 1 ft

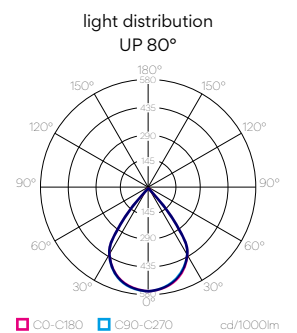
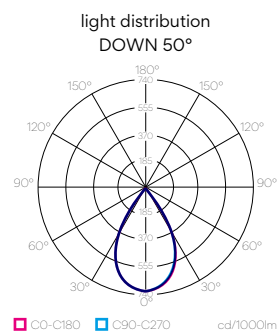
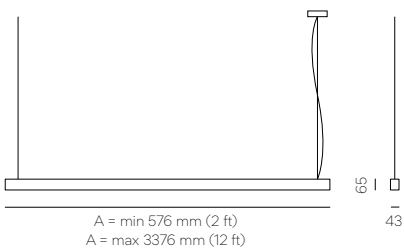

Line 43 Custom

When quality and flexibility become one, you get unexpected illumination experiences without any inconsistency. Line 43 Custom is modular linear lighting that can be smartly integrated into the architectural details of any contemporary office space. Light designed to suit particular areas and needs of office workers then appears well thought of, seamless and unobtrusive. Create your unique office lighting story with Line 43, a multifunctional, highly professional modular linear luminaire!



suspended
up & down

suspended
wall washer

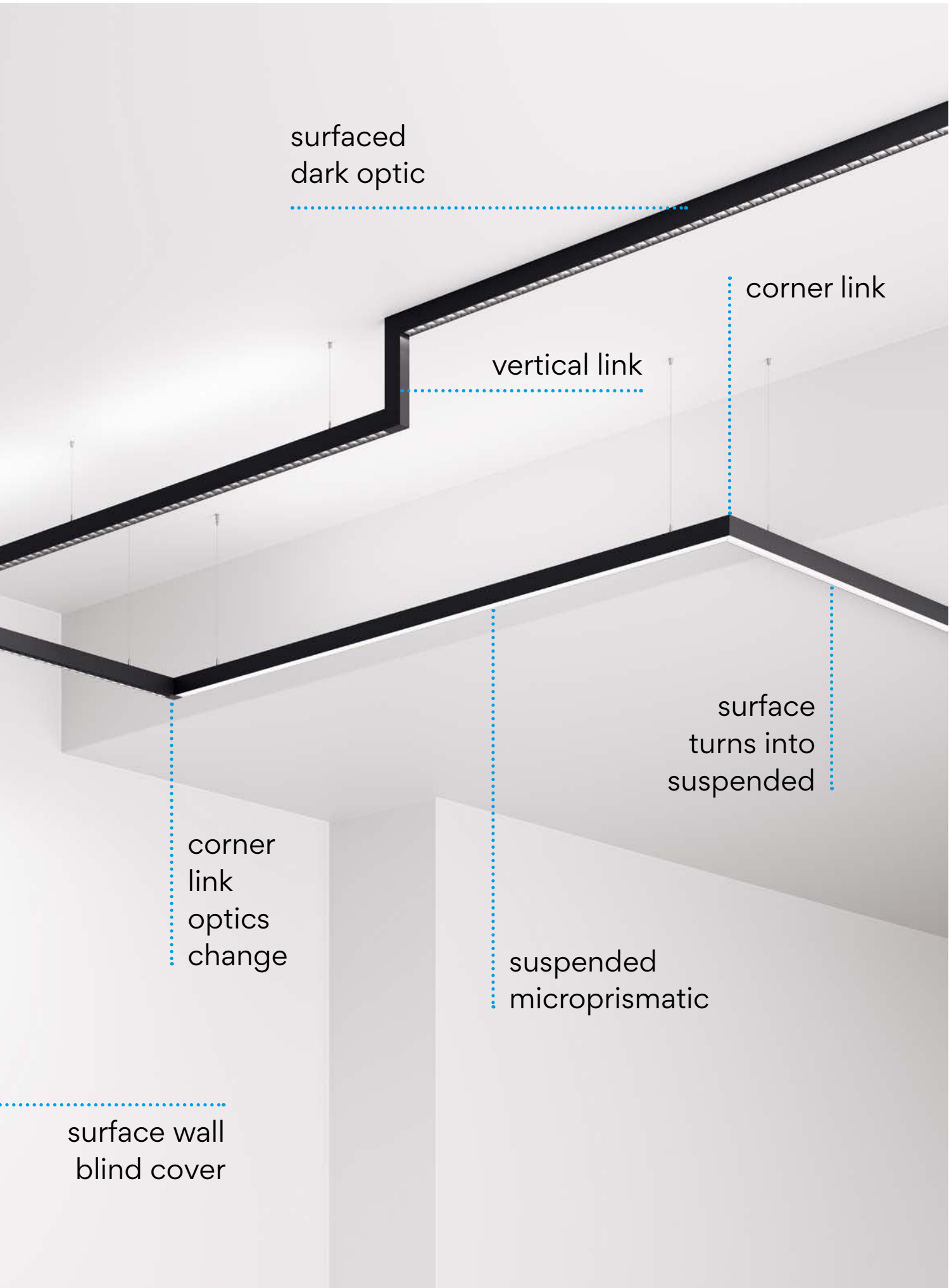

surfaced
dark optic

corner link

vertical link

surface
turns into
suspended

corner
link
optics
change

suspended
microprismatic

surface wall
blind cover

Line 28

Line 28 represents the perfect symbiosis of unlimited design options, increased uniformity, reduced glare, and decreased energy use. Create significant or minimalistic effects by combining black, white, or silver reflectors and a powder-coated frame, or tie your space together seamlessly with a single-color luminaire.

Customize your Line 28 luminaire to match your aesthetic.

Select the appropriate optics:



Opal Diffuser



Microprismatic
Diffuser



Dark Optic



Blind Cover



Jet Out

... and the reflector color
if your choice was Dark Optic:



Black matte



White matte



Silver matte



Small in size,
yet significant
in light quality.

Create your individual Line 28

Line 28 down

A = min 574 mm (2 ft)
A = max 1694 mm (6 ft)

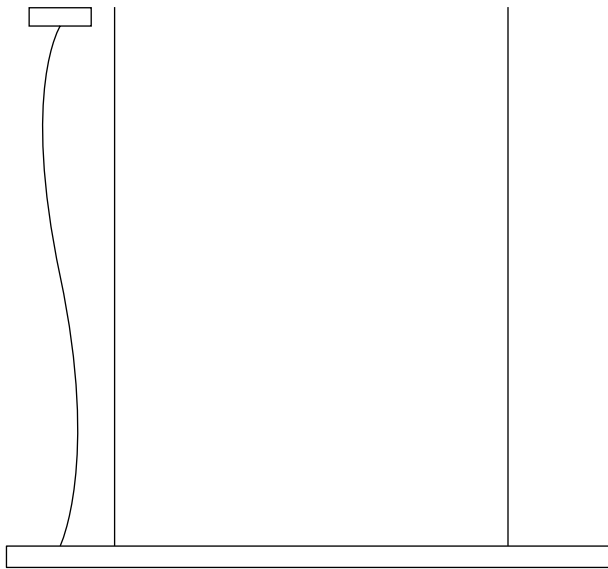

A = min 574 mm (2 ft)
A = max 1694 mm (6 ft)

Line 28 up & down

A = min 574 mm (2 ft)
A = max 1694 mm (6 ft)

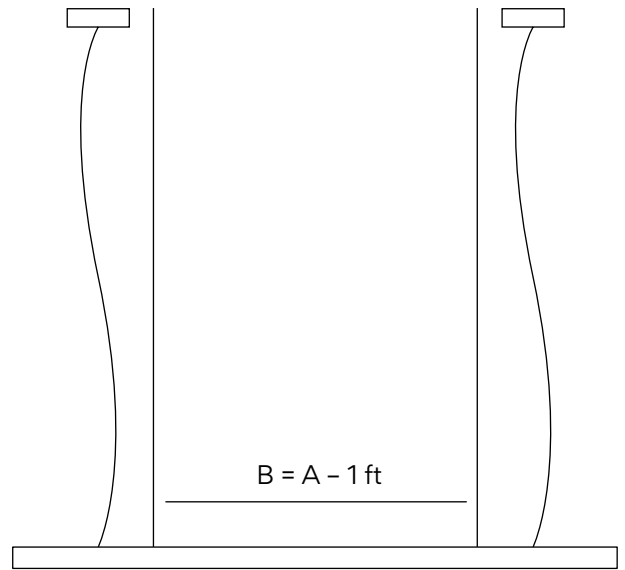

A = min 574 mm (2 ft)
A = max 1694 mm (6 ft)

Light distribution down

A = min 2 ft, max 6 ft



Light distribution down

A = min 2 ft, max 6 ft

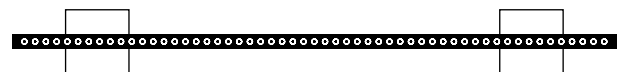

Light distribution up

B = A - 1 ft



Line 28

A = min 1974 mm (7 ft)

A = max 3374 mm (12 ft)

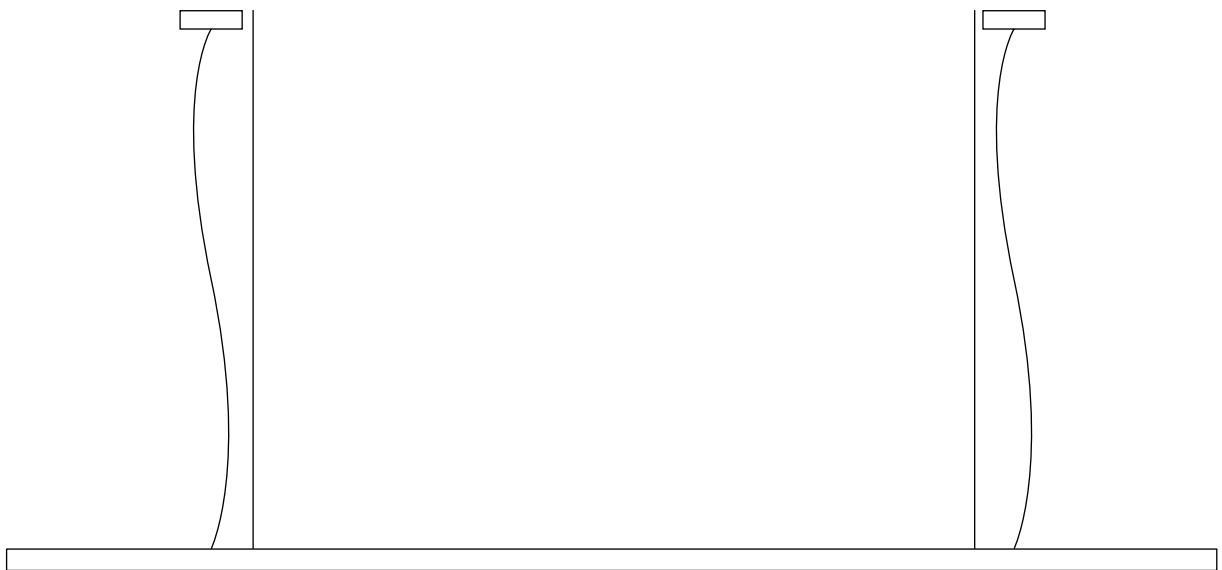

A = min 1974 mm (7 ft)
A = max 3374 mm (12 ft)

Light distribution down

A = min 7 ft, max 12 ft



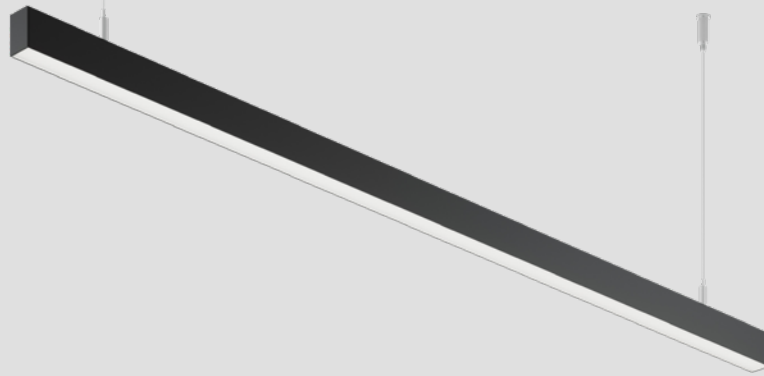

Line 28 Diffusers

EN Linear luminaire in the mini version, our profile width is only 28 mm. Following a minimalist design approach, the slim luminaire delivers both up and down-lighting. Line 28 combines scene-setting indirect lighting with a sophisticated direct light for conference rooms or workstations. The diffuser achieves a uniform light distribution and is available in three output levels and color temperatures. It allows an individual choice between a micro prismatic or opal diffuser. The housing can be painted any color from the RAL palette.

DE Langfeldleuchte in der Mini-Version, deren Profilbreite nur 28 mm beträgt. Die schlanke Leuchte folgt einem minimalistischen Designansatz und liefert sowohl nach oben als auch nach unten gerichtetes Licht. Line 28 kombiniert eine stimmungsvolle indirekte Beleuchtung mit einem raffinierten direkten Licht für Konferenzräume oder Arbeitsplätze. Der Diffusor erzielt eine gleichmäßige Lichtverteilung und ist in drei Leistungsstufen und Farbtemperaturen erhältlich. Es ermöglicht eine individuelle Wahl zwischen einem mikroprismatischen oder opalen Diffusor. Das Gehäuse kann in jeder Farbe aus der RAL-Palette lackiert werden.

Create my unique code!

71+□ - ■ - ~ - ▲ - ○ - ♣ - 00

Example

Line 28 Diffusers	opal	standard power	3000K	no reflector
↑	↑	↑	↑	↑
71	2	1 - 08	- 2 - 8	- 3 - 01 - 00
↓	↓	↓	↓	↓
pendant	size 574 mm	DALI	housing black 9005	

size		↓light	↑light	system power standard	luminous flux 4000K, opal
574 mm	■ 08	2 ft	1 ft	↓9.8W / ↑4.9W	↓632lm / ↑520lm
854 mm	■ 12	3 ft	2 ft	↓14.7W / ↑9.8W	↓984lm / ↑1040lm
1134 mm	■ 16	4 ft	3 ft	↓19.6W / ↑14.7W	↓1264lm / ↑1559lm
1414 mm	■ 20	5 ft	4 ft	↓24.5W / ↑19.6W	↓1580lm / ↑2079lm
1694 mm	■ 24	6 ft	5 ft	↓29.4W / ↑24.5W	↓1896lm / ↑2599lm
1974 mm	■ 28	7 ft	-	↓34.3W	↓2248lm
2254 mm	■ 32	8 ft	-	↓39.2W	↓2528lm
2534 mm	■ 36	9 ft	-	↓44.1W	↓2844lm
2814 mm	■ 40	10 ft	-	↓49W	↓3160lm
3094 mm	■ 44	11 ft	-	↓53.9W	↓3476lm
3374 mm	■ 48	12 ft	-	↓58.8W	↓3792lm

Technical information



UGR	<19 MPRM			
lighting power	low	~ 1		
	standard	~ 2		
	high	~ 3		
mounting type	pendant	+ 2		
	pendant up & down	+ 3		
light distribution - up	~145° x 100°			
light distribution - down	120° opal			
	60° mprpm			
luminous efficiency	LO	ST	HI	
	mprpm	65lm/W	63lm/W	60lm/W *
	opal	67lm/W	64lm/W	61lm/W *
	up	110lm/W	106lm/W	101lm/W *
electrical control	ON / OFF		▲ 9	
	DALI		▲ 8	
color temperature	3000K		● 3	
	4000K		● 4	
	on request: TUNABLE WHITE		● 9	
housing color	black 9005		● 01	
	white 9010		● 02	
	on request: RAL color palette		● 99	
optics	opal		■ 1	
	microprismatic		■ 2	
	blind cover		■ 9	

* Photometric data: 4 ft, 4000K, CRI 90

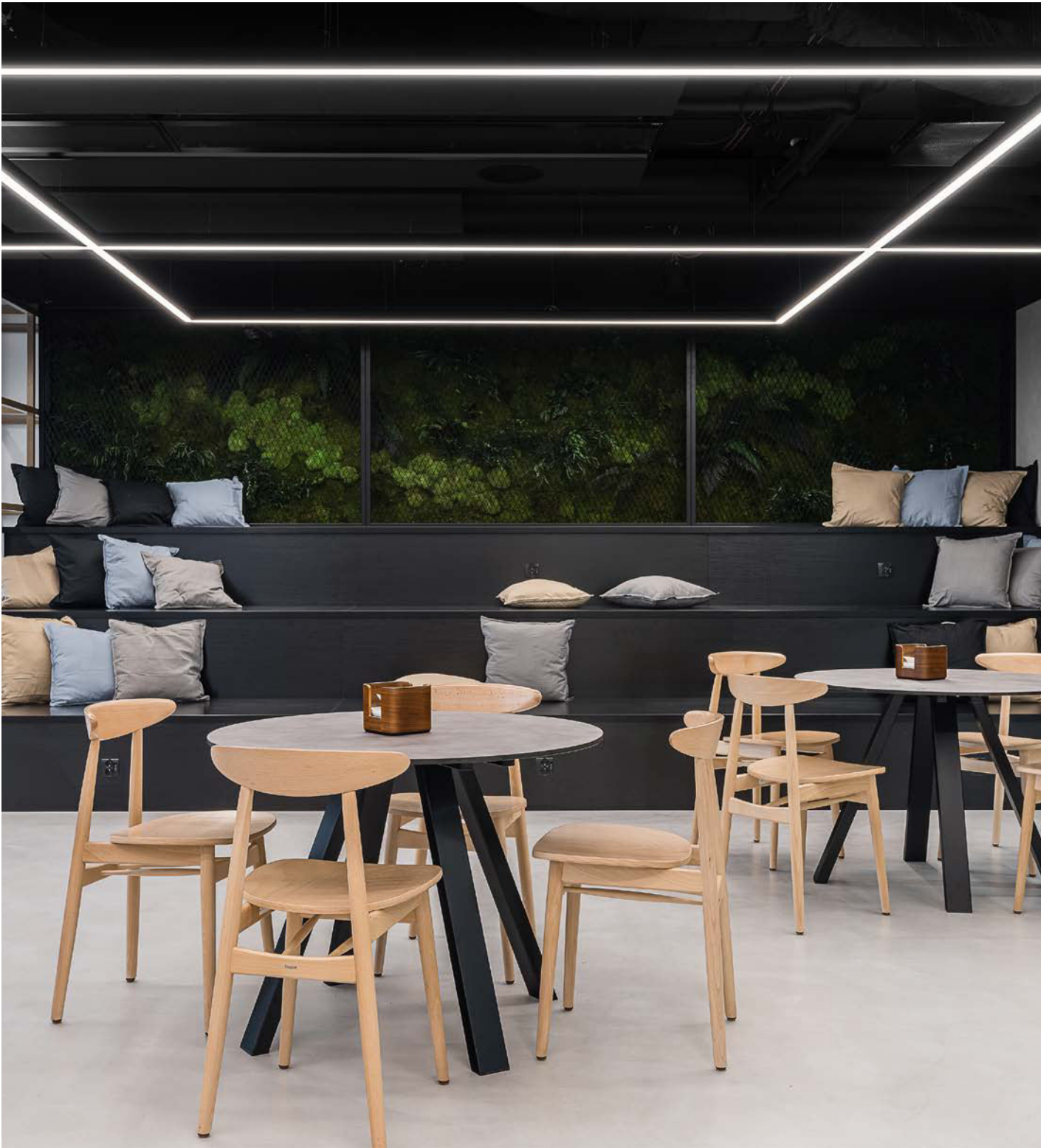

PRIVATE CLIENT THE DESIGN GROUP



light distribution
DOWN MPRM

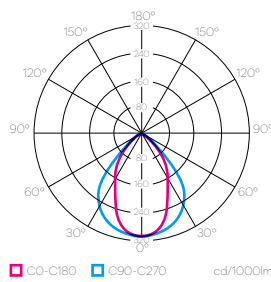

light distribution
DOWN OPAL

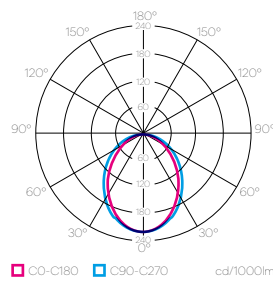

light distribution
UP

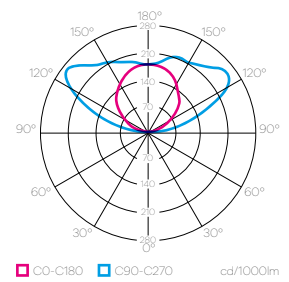

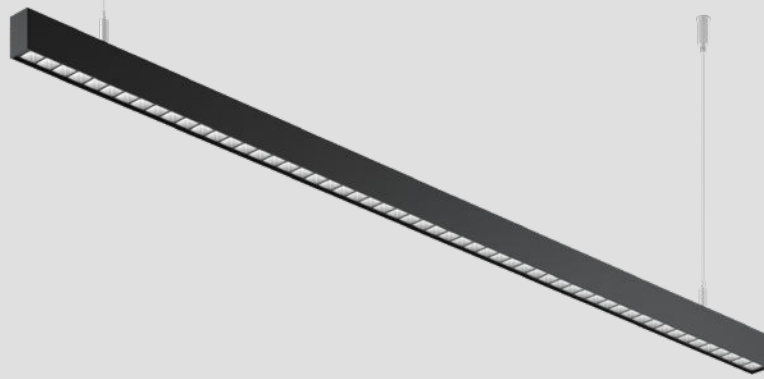

Line 28 Dark Optics

EN The design concept of Line 28 with Dark Optic lenses was to create a linear luminaire profile that catches the eye even with the power switched off. This linear luminaire's construction allows us to use miniature lenses; our profile width is only 28 mm. Following a minimalist design approach, the slim luminaire delivers both up and down-lighting. The lenses achieve a uniform light distribution and are available in three output levels and color temperatures. The luminaire has interchangeable black, white, and silver lenses. The housing can be painted any color from the RAL palette.

DE Das gestalterische Konzept der Line 28 mit Dark Optic Linsen war es, ein geradliniges Leuchtenprofil zu schaffen, das auch im ausgeschalteten Zustand ins Auge fällt. Die Konstruktion dieser linearen Leuchte ermöglicht uns die Verwendung von Miniaturlinsen; die Profildbreite beträgt nur 28 mm. Die schlanke Leuchte folgt einem minimalistischen Designansatz und liefert sowohl nach oben als auch nach unten gerichtetes Licht. Die Linsen erzielen eine gleichmäßige Lichtverteilung und sind in drei Leistungsstufen und Farbtemperaturen erhältlich. Die Leuchte hat austauschbare schwarze, weiße und silberne Reflektoren. Das Gehäuse kann in jeder Farbe aus der RAL-Palette lackiert werden.

Create my unique code!

71+□ - ■ - ~ - ▲ - ○ - ◆ - *

Example

Line 28 Dark Optics	dark optic 65°	standard power	3000K	reflector black matte
↑	↑	↑	↑	↑
71	2	3	08	2
↓	↓	↓	↓	↓
pendant	size 574 mm	DALI	housing black 9005	

71 - 2 - 3 - 08 - 2 - 8 - 3 - 01 - 01

size	↓light	↑light	system power standard	luminous flux 4000K, 65° white
574 mm ■ 08	2 ft	1 ft	↓9.8W / ↑4.9W	↓1117lm / ↑520lm
854 mm ■ 12	3 ft	2 ft	↓14.7W / ↑9.8W	↓1675lm / ↑1040lm
1134 mm ■ 16	4 ft	3 ft	↓19.6W / ↑14.7W	↓2234lm / ↑1559lm
1414 mm ■ 20	5 ft	4 ft	↓24.5W / ↑19.6W	↓2792lm / ↑2079lm
1694 mm ■ 24	6 ft	5 ft	↓29.4W / ↑24.5W	↓3351lm / ↑2599lm
1974 mm ■ 28	7 ft	-	↓34.3W	↓3909lm
2254 mm ■ 32	8 ft	-	↓39.2W	↓4468lm
2534 mm ■ 36	9 ft	-	↓44.1W	↓5026lm
2814 mm ■ 40	10 ft	-	↓49W	↓5584lm
3094 mm ■ 44	11 ft	-	↓53.9W	↓6143lm
3374 mm ■ 48	12 ft	-	↓58.8W	↓6702lm

Technical information



UGR	<19			
lighting power	low	~ 1		
	standard	~ 2		
	high	~ 3		
mounting type	pendant	+ 2		
	pendant up & down	+ 3		
light distribution - up	~145° x 100°			
light distribution - down	65° / 55°			
luminous efficiency		LO	ST	HI
	65°	118lm/W	113lm/W	108lm/W *
	55°	117lm/W	112lm/W	107lm/W *
	up	110lm/W	106lm/W	101lm/W *
electrical control	ON / OFF	▲ 9		
	DALI	▲ 8		
color temperature	3000K	● 3		
	4000K	● 4		
	on request: TUNABLE WHITE	● 9		
housing color	black 9005	◆ 01		
	white 9010	◆ 02		
	on request: RAL color palette	◆ 99		
reflector color	black matte	* 01		
	white matte	* 02		
	silver matte	* 04		
dark optics	dark optic 65°	□ 3		
	dark optic 55°	□ 4		
	blind cover	□ 9		

* Photometric data: 4 ft, 4000K, CRI 90, 65°, white reflector



VODENO TRZOP ARCHITEKCI



light distribution
DOWN 55°

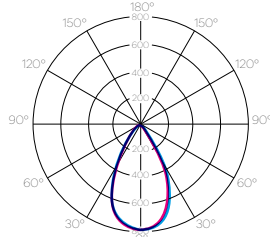

■ C0-C180 ■ C90-C270 ed/1000lm

light distribution
DOWN 65°

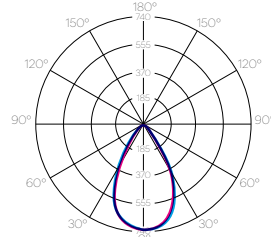

■ C0-C180 ■ C90-C270 ed/1000lm

light distribution
UP

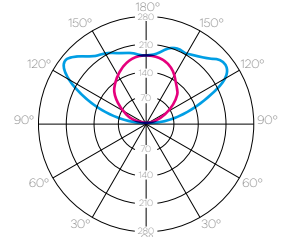

■ C0-C180 ■ C90-C270 ed/1000lm

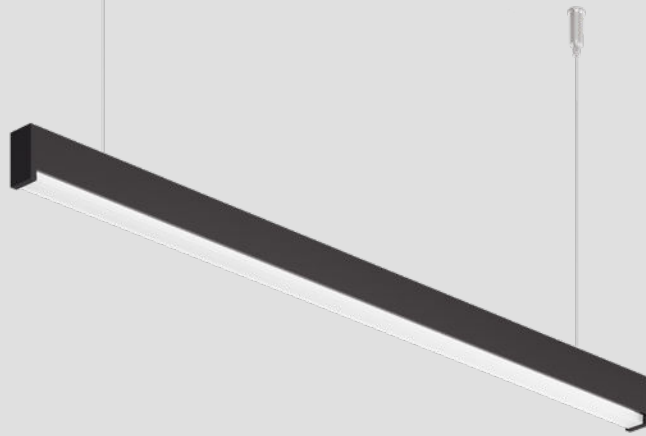

Line 28 Jet Out

EN The linear luminaire of Line 28 with the Jet Out diffuser provides one of the most sophisticated profiles in our product range. Combining performance, aesthetics, and value, the luminaire opens opportunities for various applications. Thanks to the option to extend and retract the opal diffuser, you can find the perfect combination of lights for a specific interior according to your needs. Thanks to this variability, Line 28 Jet Out can be used in virtually any area, especially in social, public, and commercial areas. Luminaires with an extended diffuser diffuse their light into a significantly larger space, thus helping to soften the entire interior. The pendant luminaire with direct or indirect light distribution is available in three output levels and color temperatures and can be painted any color from the RAL palette.

DE Die Langfeldleuchte der Line 28 mit dem Jet Out Diffusor ist eines der anspruchsvollsten Profile in unserer Produktpalette. Durch die Kombination von Leistung, Ästhetik und Wert, eröffnet die Leuchte Möglichkeiten für verschiedene Anwendungen. Dank der Möglichkeit den opalen Diffusor aus- und einzufahren, finden Sie ganz nach Ihren Bedürfnissen die perfekte Kombination von Leuchten für ein bestimmtes Interieur. Dank dieser Variabilität lässt sich Line 28 Jet Out in nahezu allen Bereichen einsetzen, insbesondere im sozialen, öffentlichen und gewerblichen Bereich. Leuchten mit einem verlängerten Diffusor streuen ihr Licht in einen deutlich größeren Bereich und tragen so dazu bei, den gesamten Innenraum weicher zu machen. Die Pendelleuchte mit direkter oder indirekter Lichtverteilung ist in drei Leistungsstufen und Farbtemperaturen erhältlich und kann in jeder beliebigen Farbe aus der RAL-Palette lackiert werden.

Example

Line 28	Dark Optics	jet out	standard power	3000K	no reflector
↑	↑	↑	↑	↑	↑
71	2	8	08	2	8
				3	01
					00
	↓	↓	↓	↓	↓
	pendant	size 574 mm	DALI	housing black 9005	

size		↓light	↑light	system power standard	luminous flux 4000K, opal
574 mm	■ 08	2 ft	1 ft	↓9.8W / ↑4.9W	↓646lm / ↑520lm
854 mm	■ 12	3 ft	2 ft	↓14.7W / ↑9.8W	↓969lm / ↑1040lm
1134 mm	■ 16	4 ft	3 ft	↓19.6W / ↑14.7W	↓1292lm / ↑1559lm
1414 mm	■ 20	5 ft	4 ft	↓24.5W / ↑19.6W	↓1615lm / ↑2079lm
1694 mm	■ 24	6 ft	5 ft	↓29.4W / ↑24.5W	↓1938lm / ↑2599lm
1974 mm	■ 28	7 ft	-	↓34.3W	↓2261lm
2254 mm	■ 32	8 ft	-	↓39.2W	↓2584lm
2534 mm	■ 36	9 ft	-	↓44.1W	↓2907lm
2814 mm	■ 40	10 ft	-	↓49W	↓3230lm
3094 mm	■ 44	11 ft	-	↓53.9W	↓3553lm
3374 mm	■ 48	12 ft	-	↓58.8W	↓3876lm

Technical information



lighting power	low	~ 1		
	standard	~ 2		
	high	~ 3		
mounting type	pendant	+ 2		
	pendant up & down	+ 3		
light distribution - up	~145° x 100°			
light distribution - down	120° jet mid			
	120° jet out			
luminous efficiency	LO	ST	HI	
	jet mid	68lm/W	65lm/W	62lm/W *
	jet out	68lm/W	65lm/W	62lm/W *
	up	110lm/W	106lm/W	101lm/W *
electrical control	ON / OFF	▲ 9		
	DALI	▲ 8		
color temperature	3000K	● 3		
	4000K	● 4		
	on request: TUNABLE WHITE	● 9		
housing color	black 9005	◆ 01		
	white 9010	◆ 02		
	on request: RAL color palette	◆ 99		

* Photometric data: 4 ft, 4000K, CRI 90

Create my unique code!

71+8 - ■ - ~ - ▲ - ● - ◆ - 00



light distribution
MID JET

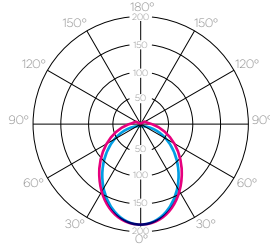

■ CO-C180 ■ C90-C270 cd/1000lm

light distribution
JET OUT

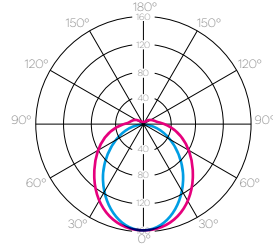

■ CO-C180 ■ C90-C270 cd/1000lm

light distribution
UP

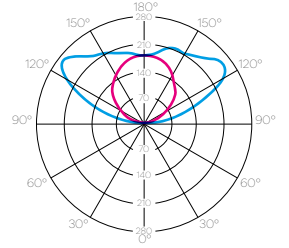

■ CO-C180 ■ C90-C270 cd/1000lm



Line 28 Dot System

EN Line 28 Dot System is an imposing pendant luminaire that fascinates its sculptural look and allows for a versatile range of arrangements. While it exudes a relatively lightweight look as a single structure linked in the shape of a triangle or square, it reveals a distinctive sculptural effect when arranged in a monumental geometric hexagon scheme. The structure of each Dot System luminaire consists of three or four sections of the Line 28 profile equipped with advanced optics, which are connected in a triangle or square shape through cylindrical „Dot“ connectors. Suppose you want to improve the acoustics of your office space additionally. In that case, it is possible to fill the distance between the elements of the Dot System with a high-quality sound-absorbing panel.

DE Line 28 Dot System ist eine imposante Pendelleuchte, die durch ihre skulpturale Anmutung fasziniert und vielseitig arrangiert werden kann. Während es als einzelne Struktur die in Form eines Dreiecks oder Quadrats verbunden ist, ein relativ leichtes Aussehen ausstrahlt, zeigt es einen unverwechselbaren skulpturalen Effekt, wenn es in einem monumentalen geometrischen Hexagon-Schema angeordnet ist. Die Struktur jeder Dot System-Leuchte besteht aus drei oder vier Abschnitten des Line 28-Profiles, das mit fortschrittlicher Optik ausgestattet ist und durch zylindrische „Dot“-Verbindungsstücke in Dreiecks- oder Quadratform verbunden ist. Angenommen, Sie möchten die Akustik Ihrer Büroräume zusätzlich verbessern. In diesem Fall ist es möglich, den Abstand zwischen den Elementen des Dot-Systems mit einer hochwertigen schallabsorbierenden Paneel zu füllen.

Example

Line 28 Dot System	dark optic 65°	standard power	3000K	reflector black matte
↑	↑	↑	↑	↑
75	2	3	40	2
				8
				3
				01
				01
↓	↓	↓	↓	↓
pendant	4 ft ↓ Blind ↑	DALI	housing black 9005	

Quickinfo

	LO	ST	HI
system power	↓9.6W	↓19.6W	↓30W
luminous flux	65° ↓1141lm	↓2234lm	↓3259lm *
	55° ↓1127lm	↓2205lm	↓3217lm *
	up ↓1062lm	↓2079lm	↓3034lm *
UGR	<19		

Technical information

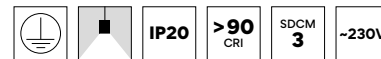

lighting power	low	~ 1		
	standard	~ 2		
	high	~ 3		
mounting type	pendant	+ 2		
	pendant up & down	+ 3		
light distribution - up	~145° × 100°			
light distribution - down	65° / 55°			
luminous efficiency	LO	ST	HI	
	65°	118lm/W	113lm/W	108lm/W *
	55°	117lm/W	112lm/W	107lm/W *
	up	110lm/W	106lm/W	101lm/W *
electrical control	ON / OFF	▲ 9		
	DALI	▲ 8		
color temperature	3000K	● 3		
	4000K	● 4		
	on request: TUNABLE WHITE	● 9		
luminaire color	black 9005	● 01		
	white 9010	● 02		
	on request: RAL color palette	● 99		
reflector color	black matte	* 01		
	white matte	* 02		
	silver matte	* 04		
dark optics	dark optic 65°	■ 3		
	dark optic 55°	■ 4		
	blind cover	■ 9		
	on request: opal, microprismatic			

Photometric data: 4 ft, 4000K, CRI 90, 65°, white reflector

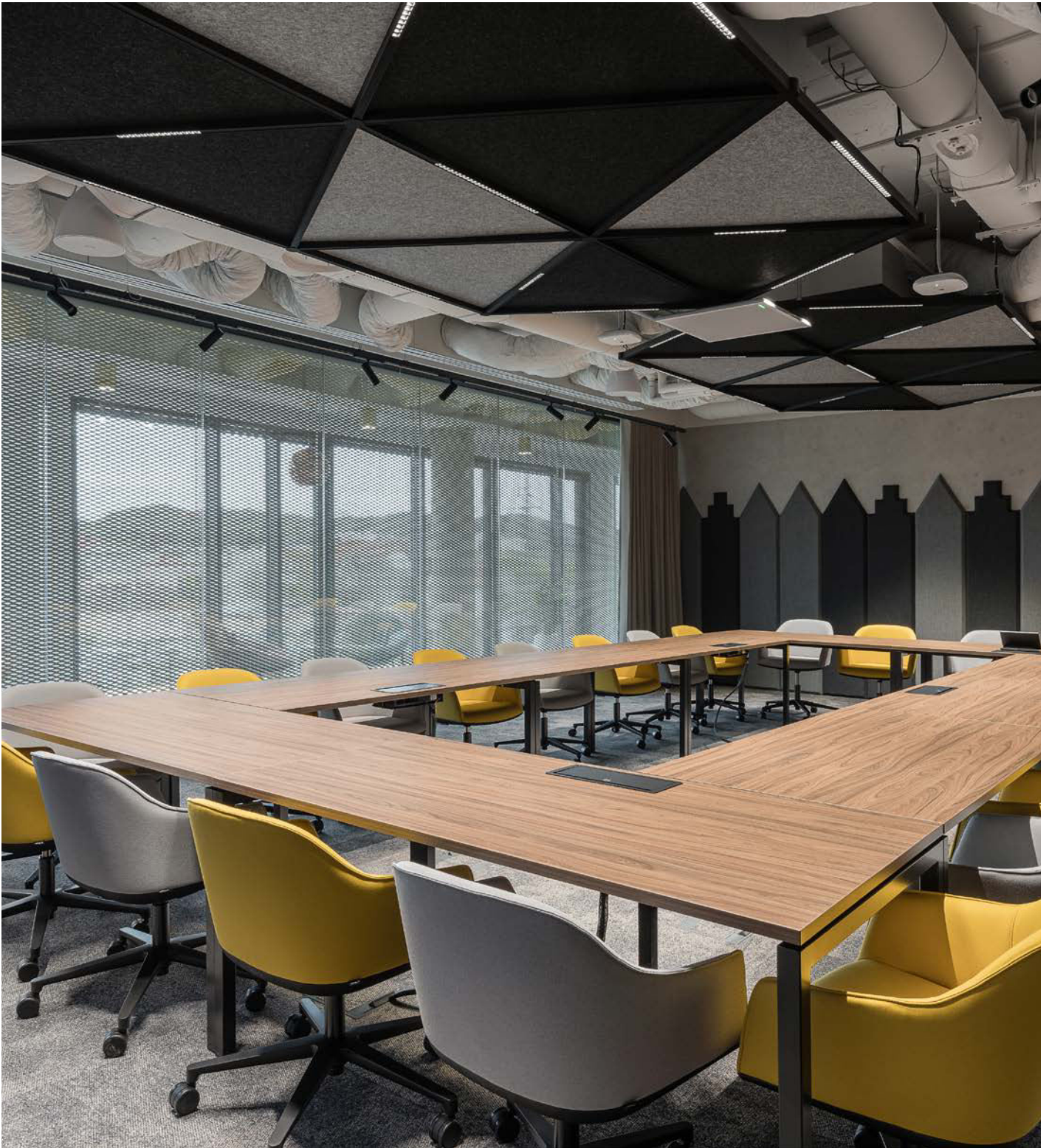

ERGO GDAŃSK TRZÓP ARCHITEKCI

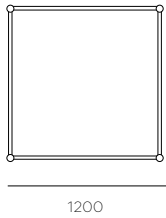
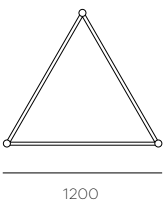

Create your individual Line 28 Dot System

STEP 1 Choose the base shape for Dot configuration:

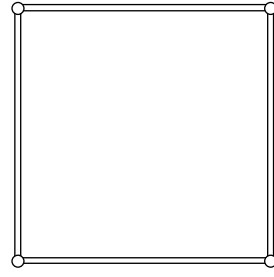
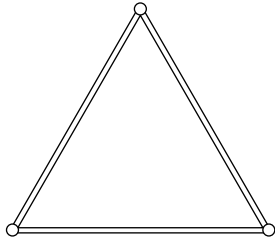

STEP 2 Use your imagination and set up the Dot System composition to suit your needs.

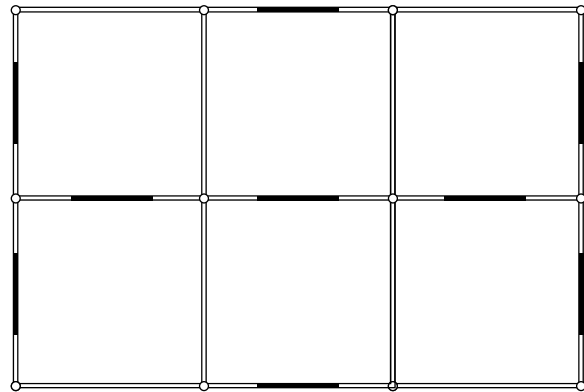
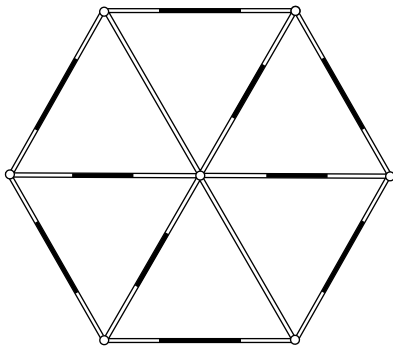

STEP 3 Create your unique Dot System code!

To order the Line 28 Dot System correctly, please submit your order codes according to the following instructions:

FIRSTLY: Count all the DOT connections and order the correct number.

SECOND: Decide if you want the Dot System with or without an acoustic panel.
Choose the color of the ecoPET from page 266.

THIRD: Configure lighting on each linear profile.

Example:

Dot System Triangle with acoustic panel

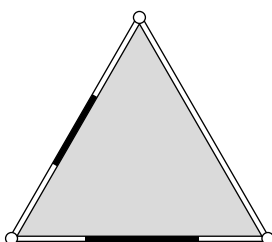

3 × DOT CONNECTOR:

3 × 7520-90

ACOUSTIC PANEL:

7520-91-ecoPET (select color from page 266)

LIGHTING CONFIGURATION:

Blind ↓ Blind ↑: 7523-00-2-8-3-01-01

2 ft ↓ Blind ↑: 7523-20-2-8-3-01-01

2 ft ↓ 3 ft ↑: 7523-23-2-8-3-01-01

Component code list for Line 28 Dot System:



Dot Connector
7520-90

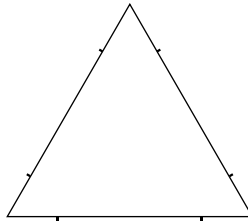

Triangle Acoustic Panel
7520-91-ecoPET

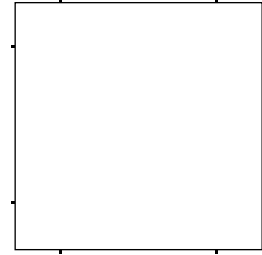

Square Acoustic Panel
7520-92-ecoPET

Lighting configuration:

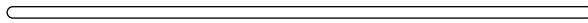

- Line 28 (1200) Blind ↓ Blind ↑
- Line 28 (1200) Blind ↓ 1 ft ↑
- Line 28 (1200) Blind ↓ 2 ft ↑
- Line 28 (1200) Blind ↓ 3 ft ↑



- Line 28 (1200) 1 ft ↓ Blind ↑
- Line 28 (1200) 1 ft ↓ 1 ft ↑
- Line 28 (1200) 1 ft ↓ 2 ft ↑
- Line 28 (1200) 1 ft ↓ 3 ft ↑



- Line 28 (1200) 2 ft ↓ Blind ↑
- Line 28 (1200) 2 ft ↓ 1 ft ↑
- Line 28 (1200) 2 ft ↓ 2 ft ↑
- Line 28 (1200) 2 ft ↓ 3 ft ↑



- Line 28 (1200) 3 ft ↓ Blind ↑
- Line 28 (1200) 3 ft ↓ 1 ft ↑
- Line 28 (1200) 3 ft ↓ 2 ft ↑
- Line 28 (1200) 3 ft ↓ 3 ft ↑



- Line 28 (1200) 4 ft ↓ Blind ↑
- Line 28 (1200) 4 ft ↓ 1 ft ↑
- Line 28 (1200) 4 ft ↓ 2 ft ↑
- Line 28 (1200) 4 ft ↓ 3 ft ↑

Create my unique code!

- 752◻ - 00 - ~ - ▲ - ○ - ◻ - *
- 752◻ - 01 - ~ - ▲ - ○ - ◻ - *
- 752◻ - 02 - ~ - ▲ - ○ - ◻ - *
- 752◻ - 03 - ~ - ▲ - ○ - ◻ - *

- 752◻ - 10 - ~ - ▲ - ○ - ◻ - *
- 753◻ - 11 - ~ - ▲ - ○ - ◻ - *
- 753◻ - 12 - ~ - ▲ - ○ - ◻ - *
- 753◻ - 13 - ~ - ▲ - ○ - ◻ - *

- 752◻ - 20 - ~ - ▲ - ○ - ◻ - *
- 753◻ - 21 - ~ - ▲ - ○ - ◻ - *
- 753◻ - 22 - ~ - ▲ - ○ - ◻ - *
- 753◻ - 23 - ~ - ▲ - ○ - ◻ - *

- 752◻ - 30 - ~ - ▲ - ○ - ◻ - *
- 753◻ - 31 - ~ - ▲ - ○ - ◻ - *
- 753◻ - 32 - ~ - ▲ - ○ - ◻ - *
- 753◻ - 33 - ~ - ▲ - ○ - ◻ - *

- 752◻ - 40 - ~ - ▲ - ○ - ◻ - *
- 753◻ - 41 - ~ - ▲ - ○ - ◻ - *
- 753◻ - 42 - ~ - ▲ - ○ - ◻ - *
- 753◻ - 43 - ~ - ▲ - ○ - ◻ - *

Line 30 Oval

See the light of flexxica's masterly designed linear luminaire! This pendant luminaire meets sophisticated user demands by combining craftsmanship with contemporary lighting comfort. Create a stunning impression with Line 30 Oval, with the aesthetically pleasing way it floats.

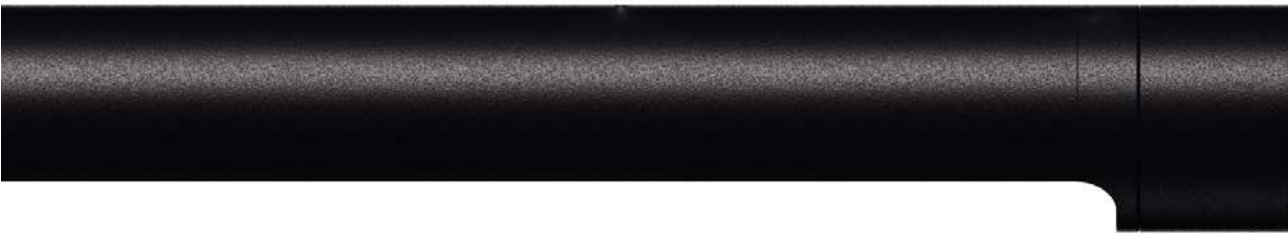

Choose your optics!
Dark Optic or Diffuser?



Dark Optic



Diffuser



With its 30 mm diameter,
it presents a slim appearance.

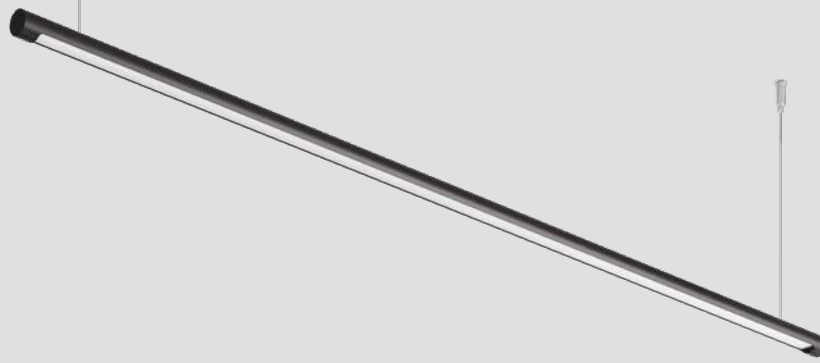

Line 30 Oval Diffusers

EN Line 30 Oval is a minimalist pendant luminaire that fascinates its straightforward geometric design, which exudes a simple and distinctive appearance. This technically sophisticated decorative lighting invites users to realize impressive light installations creatively and showcases a surprising filigree contour. Allowing for appealing light installations, Line 30 Oval offers ingenious mounting options such as a single pendant luminaire over the reception desk or a decorative set of luminaires hung at different heights and different angles of inclination. With its small diameter of 30 mm, the LED lamp showcases an exceptionally slim appearance. The end caps have a slightly concave curve that discreetly surrounds the power cord, which emphasizes the floating character of this lightweight pendant luminaire. The diffuser achieves a uniform light distribution and is available in three output levels and color temperatures.

DE Line 30 Oval ist eine minimalistische Pendelleuchte, die durch ihr geradliniges, geometrisches Design fasziniert, das ein schlichtes und unverwechselbares Erscheinungsbild ausstrahlt. Diese technisch anspruchsvolle Dekorationsbeleuchtung lädt dazu ein, eindrucksvolle Lichtinstallationen kreativ zu realisieren und überrascht mit einer filigranen Kontur. Für ansprechende Lichtinstallationen bietet Line 30 Oval ausgeklügelte Montagemöglichkeiten wie eine einzelne Pendelleuchte über dem Empfangstresen oder ein dekoratives Leuchteset in unterschiedlichen Höhen und unterschiedlichen Neigungswinkeln. Mit ihrem geringen Durchmesser von 30 mm präsentiert sich die LED-Leuchte besonders schlank. Die leicht konkav gewölbten Endkappen umrahmen dezent das seitlich einzuführende Stromkabel, was den schwebenden Charakter der leichten Pendelleuchte verstärkt. Der Diffusor erzielt eine gleichmäßige Lichtverteilung und ist in drei Leistungsstufen und Farbtemperaturen erhältlich.

Example

Line 30 Diffusers	opal	standard power	3000K	no reflector
↑	↑	↑	↑	↑
74	2	1 - 08 - 2 - 8 - 3 - 01 - 00		
↓	↓	↓	↓	↓
pendant	size 616 mm	DALI	housing black 9005	

size		↓light	system power standard	luminous flux 4000K, opal
616 mm	■ 08	2 ft	↓9.8W	↓632lm
896 mm	■ 12	3 ft	↓14.7W	↓984lm
1176 mm	■ 16	4 ft	↓19.6W	↓1264lm
1456 mm	■ 20	5 ft	↓24.5W	↓1580lm
1736 mm	■ 24	6 ft	↓29.4W	↓1896lm
2016 mm	■ 28	7 ft	↓34.3W	↓2248lm
2296 mm	■ 32	8 ft	↓39.2W	↓2528lm
2576 mm	■ 36	9 ft	↓44.1W	↓2844lm
2856 mm	■ 40	10 ft	↓49W	↓3160lm
3136 mm	■ 44	11 ft	↓53.9W	↓3476lm
3416 mm	■ 48	12 ft	↓58.8W	↓3792lm

Technical information

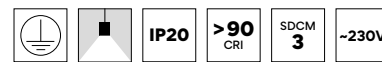

UGR	<19 MPRM			
lighting power	low	~ 1		
	standard	~ 2		
	high	~ 3		
light distribution - down	120° opal			
	60° mprpm			
luminous efficiency	LO	ST	HI	
	mprm	65lm/W	63lm/W	60lm/W *
	opal	67lm/W	64lm/W	61lm/W *
electrical control	ON/OFF	▲ 9		
	DALI	▲ 8		
color temperature	3000K	● 3		
	4000K	● 4		
	on request: TUNABLE WHITE	● 9		
housing color	black 9005	◆ 01		
	white 9010	◆ 02		
	on request: RAL color palette	◆ 99		
optics	opal	■ 1		
	microprismatic	■ 2		

* Photometric data: 4 ft, 4000K, CRI 90

Create my unique code!

742■ - ■ - ~ - ▲ - ● - ◆ - 00

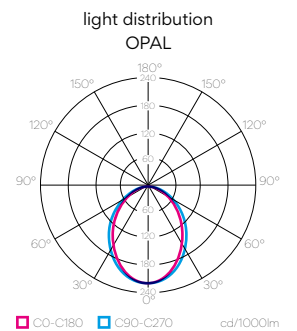
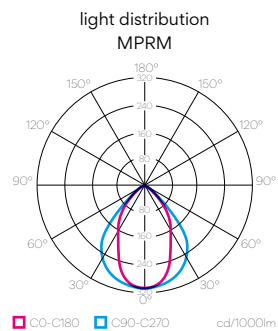
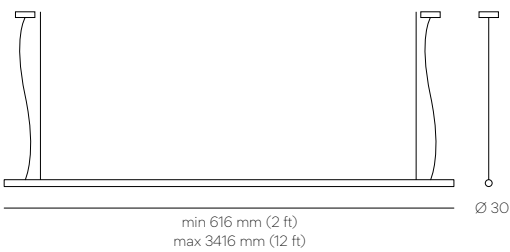
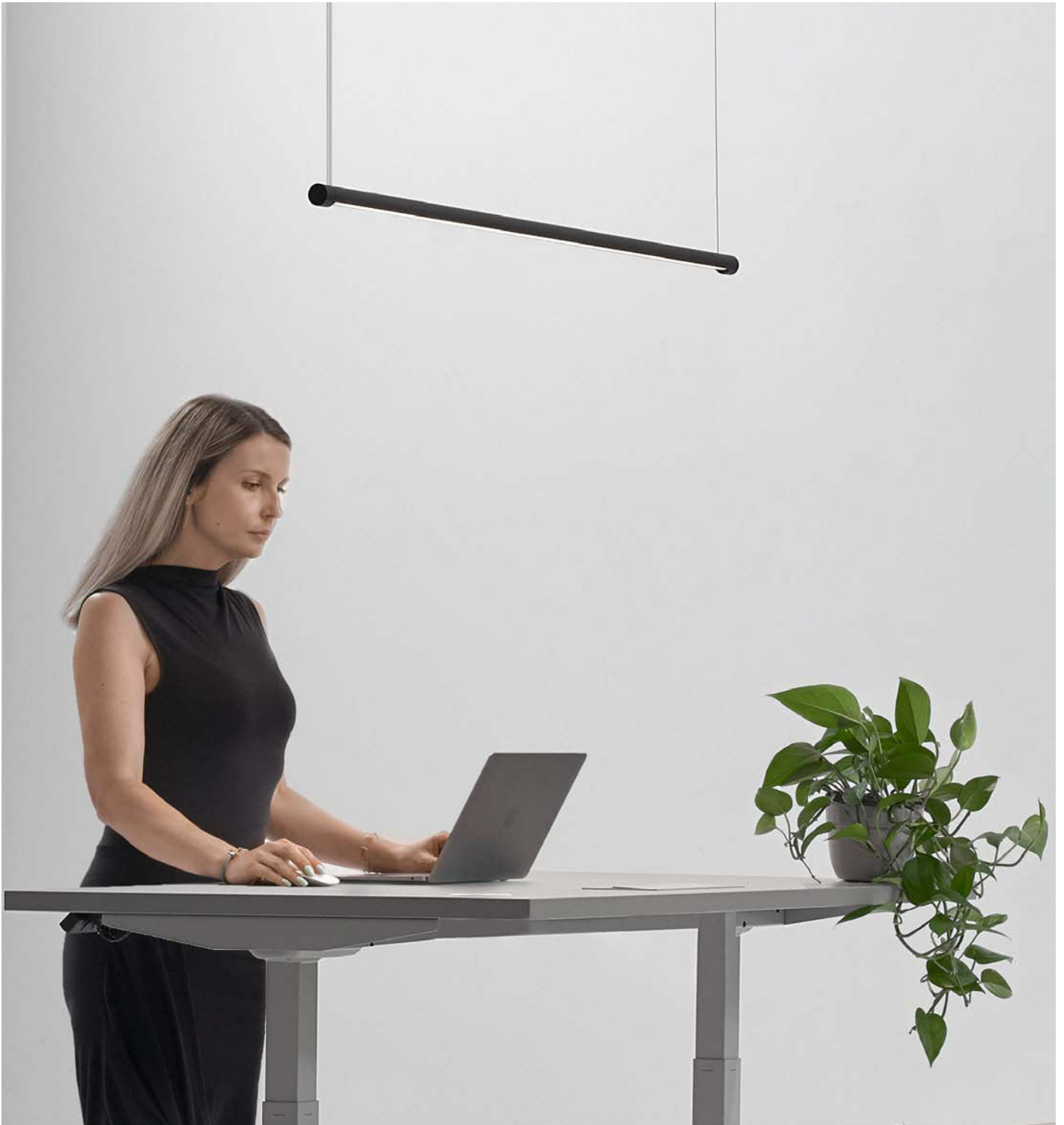



Line 30 Oval Dark Optics

EN Line 30 Oval in Dark Optic stands out due to its straightforward and modern appearance, and the curved end caps enhance the floating character of the lightweight pendant luminaire. When 6 ft long, it surprises with a filigree contour that measures only 30 mm. The luminaire is equipped with innovative, high-performance advanced optics lens technology to achieve outstanding lighting quality in the workplace. The lenses perform a uniform light distribution and are available in three output levels and color temperatures. The luminaire has interchangeable black, white, and silver lenses. The housing can be painted any color from the RAL palette.

DE Line 30 Oval in Dark Optic besticht durch ihr geradliniges und modernes Erscheinungsbild, die geschwungenen Endkappen verstärken den schwebenden Charakter der leichten Pendelleuchte. Bei 180 cm Länge überrascht er mit einer filigranen Kontur, die nur 30 mm misst. Die Leuchte ist mit innovativer, leistungsstarker Advanced-Optics-Linsentechnologie ausgestattet, um eine hervorragende Lichtqualität am Arbeitsplatz zu erreichen. Die Linsen sorgen für eine gleichmäßige Lichtverteilung und sind in drei Leistungsstufen und Farbtemperaturen erhältlich. Die Leuchte hat austauschbare schwarze, weiße und silberne Reflektoren. Das Gehäuse kann in jeder beliebigen Farbe aus der RAL-Palette lackiert werden.

Example

Line 30 Dark Optics	dark optic 65°	standard power	3000K	reflector black matte
↑	↑	↑	↑	↑
74	2	3 - 08	- 2 - 8 - 3	- 01 - 01
↓	↓	↓	↓	↓
pendant	size 616 mm	DALI	housing black 9005	

size		↓light	system power standard	luminous flux 4000K, 65° white
616 mm	■ 08	2 ft	↓9.8W	↓1117lm
896 mm	■ 12	3 ft	↓14.7W	↓1675lm
1176 mm	■ 16	4 ft	↓19.6W	↓2234lm
1456 mm	■ 20	5 ft	↓24.5W	↓2792lm
1736 mm	■ 24	6 ft	↓29.4W	↓3351lm
2016 mm	■ 28	7 ft	↓34.3W	↓3909lm
2296 mm	■ 32	8 ft	↓39.2W	↓4468lm
2576 mm	■ 36	9 ft	↓44.1W	↓5026lm
2856 mm	■ 40	10 ft	↓49W	↓5584lm
3136 mm	■ 44	11 ft	↓53.9W	↓6143lm
3416 mm	■ 48	12 ft	↓58.8W	↓6702lm

Technical information

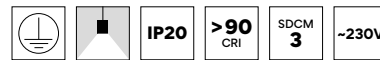

UGR	<19			
lighting power	low	~ 1		
	standard	~ 2		
	high	~ 3		
light distribution - down	65° / 55°			
luminous efficiency	LO	ST	HI	
	65°	118lm/W	113lm/W	108lm/W *
	55°	117lm/W	112lm/W	107lm/W *
electrical control	ON / OFF			
	DALI			
color temperature	3000K			
	4000K			
	on request:	TUNABLE WHITE		
housing color	black 9005			
	white 9010			
	on request:	RAL color palette		
reflector color	black matte			
	white matte			
	silver matte			
dark optics	dark optic 65°			
	dark optic 55°			

* Photometric data: 4 ft, 4000K, CRI 90, 65°, white reflector

Create my unique code!

742□ - ■ - ~ - ▲ - ● - ◆ - *

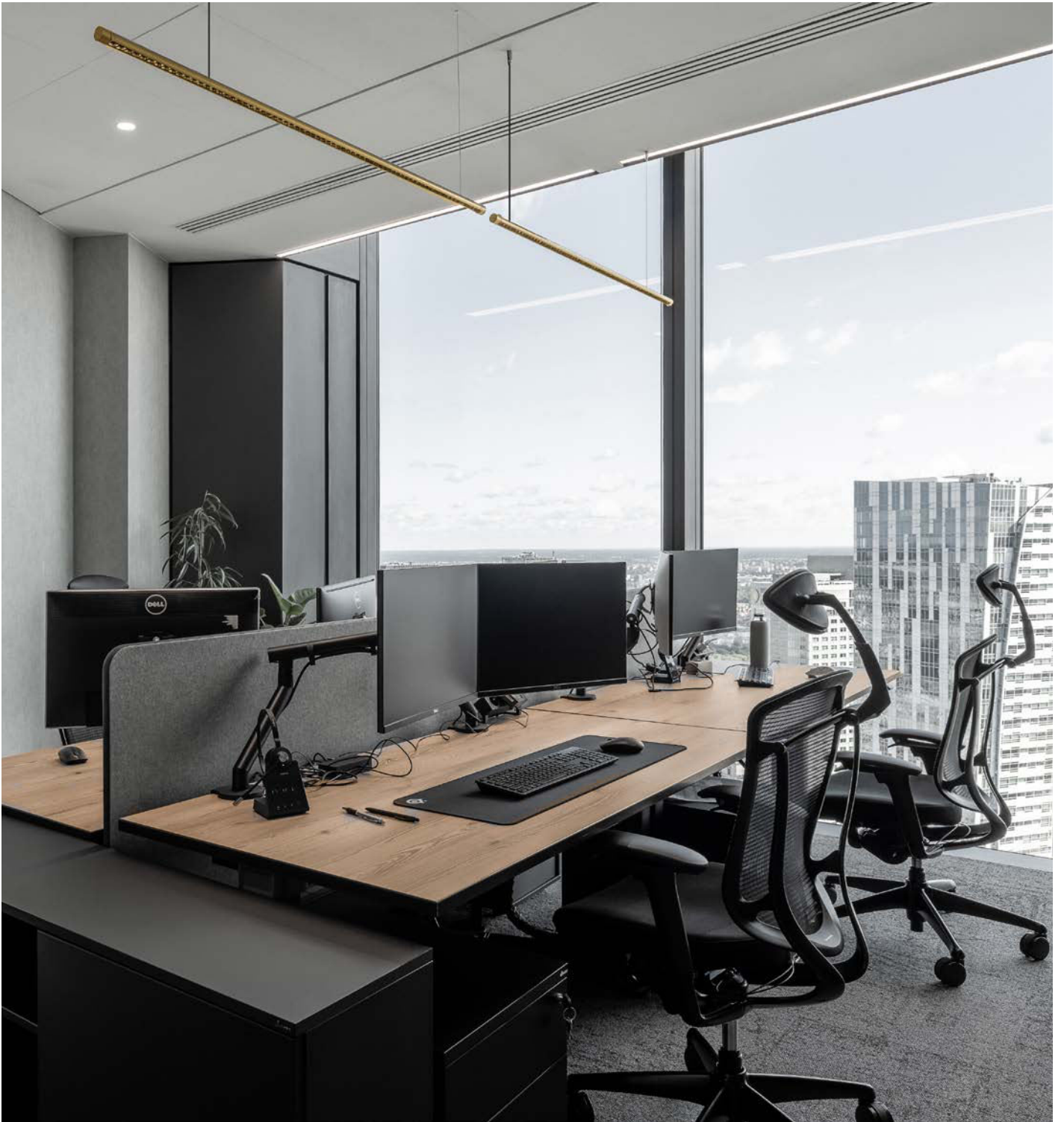

CMS LAW FIRM TRZOP ARCHITEKCI

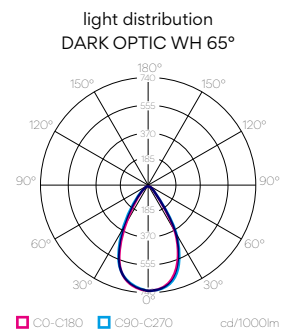
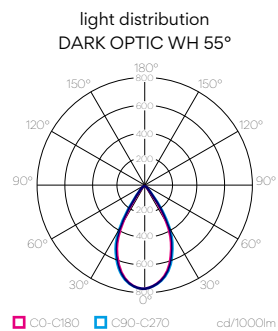
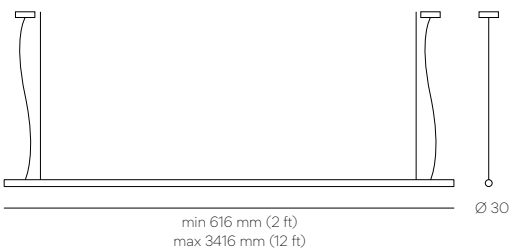



Cube

EN Cube is a line of minimalist, modern ceiling downlights made from aluminum powder-coated in any RAL color. The architects love this combination of a simple yet interesting design available in four mounting options to choose from with a high-quality LED light source and a European power supply. It will certainly be appreciated by those who prefer simple and convenient design. It will look great in any room of a residential apartment, office or shop, whether it is decorated in a classical or modern style.

DE Cube ist eine Serie minimalistischer, moderner Deckenleuchten des Typs Downlight, hergestellt aus pulverbeschichtetem Aluminium in jeder RAL-Farbe zur Wahl. Die Serie ist unter Architekten dank der Kombination von schlichtem, aber interessantem Design, das in vier Montageoptionen erhältlich ist, mit einer hochwertigen LED-Lichtquelle und einem Netzgerät aus europäischer Herstellung sehr beliebt. Die perfekte Wahl für alle, die einfache und komfortable Lösungen bevorzugen. Die Leuchten präsentieren sich in jedem Raum Ihrer Wohnung, Ihres Büros oder Geschäfts hervorragend – egal ob klassisch oder modern eingerichtet.

Example

Cube	standard power	3000 K	black matte optics	no textil
↑	↑	↑	↑	↑
3103 - 00	- 2 - 8	- 3 - 01	- 01 - 2	- 00
↓	↓	↓	↓	↓
one size	DALI	luminaire black 9005	pendant	

Quickinfo

luminaire size	105×105×1.5 (recessed with frame) 83×83×150 (surface) 83×83×780 (pendant)
system power	↓10W low ↓10W low ↓15W standard ↓15W standard
luminous flux	↓1060lm / ↓1530lm ↓924lm / ↓1237lm
UGR	<16 <16
CRI	>80 >90
luminous efficiency	100lm/W 80lm/W

Technical information

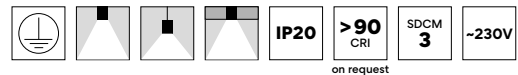

lighting power	low ~ 1 standard ~ 2
mounting type	surface ☾ 1 pendant ☾ 2 recessed with frame ☾ 5
light distribution – down	80°
electrical control	ON / OFF ▲ 9 DALI ▲ 8
color temperature	3000K ● 3 4000K ● 4 on request: TUNABLE WHITE ● 9
frame color	black 9005 ⬤ 01 on request: RAL color palette ⬤ 99
optic	black matte * 01 white matte * 02 silver matte * 04 on request: gold matte * 05

Create my unique code!

3103 - 00 - ~ - ▲ - ● - ⬤ - * - ☾ - 00

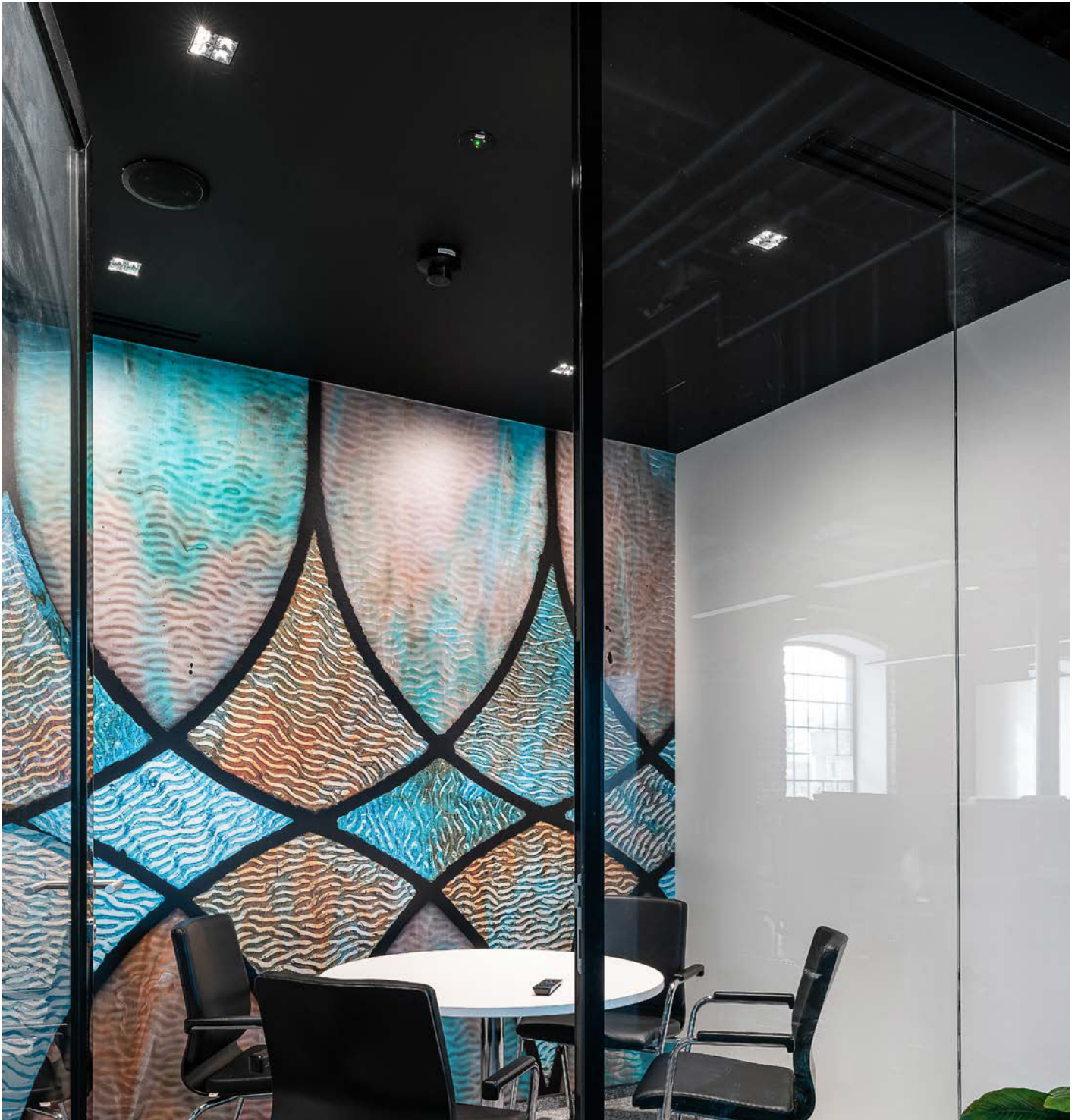

CLARIANT THE DESIGN GROUP

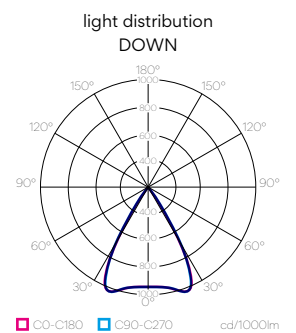
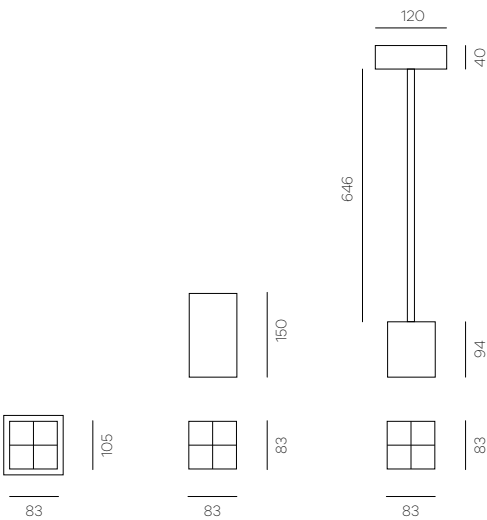



Nola

EN The Nola surface-mounted lamp is a premium product with a simple, modern design. By default, it comes in two color housing versions of: black and white, but as an option it can also be powder-coated in any RAL color of your choice. The reflector is available in black, white, gold and silver. The Nola luminaire is made from high-quality European-made components (COB LED, power supply) and easy assembly is an additional advantage. It is perfect as lighting in offices, passageways, open spaces, shopping facilities, galleries and museums.

DE Die Aufputzleuchte Nola ist ein Produkt der Premium-Klasse mit schlichtem, modernem Design. Standardmäßig ist sie in zwei Gehäusefarben erhältlich: Schwarz und Weiß, optional kann sie aber auch in jeder anderen RAL-Farbe pulverbeschichtet werden. Der Reflektor ist in folgenden Farben erhältlich: Schwarz, Weiß, Gold und Silber. Die Nola-Leuchte besteht aus hochwertigen Komponenten europäischer Herstellung (COB-Led, Netzgerät) und überzeugt durch die einfache Montage. Sie eignet sich hervorragend zur Beleuchtung von Büros, Fluren, Open Space-Flächen, Geschäftsräumen und Einkaufszentren, Galerien und Museen.

Example

Nola	standard power	3000 K	black reflector	no textil
↑	↑	↑	↑	↑
3104 - 00 - 2 - 8 - 3 - 01 - 01 - 2 - 00				
↓	↓	↓	↓	↓
one size	DALI	luminaire black 9005	pendant	

Quickinfo

	LO	ST	HI
luminaire size	Ø140 × 162		
system power	↓10W	↓15W	↓23W
luminous flux	↓892lm	↓1248lm	↓1784lm
UGR	<19		

Technical information



lighting power	low	standard	high	~ 1	~ 2	~ 3		
mounting type	surface	pendant		☾ 1	☾ 2			
light distribution - down	40°							
luminous efficiency	LO	ST	HI	↓84lm/W	↓83lm/W	↓78lm/W		
electrical control	ON / OFF			DALI			▲ 9	▲ 8
color temperature	3000K			4000K			● 3	● 4
luminaire color	black 9005			white 9010			◆ 01	◆ 02
reflector color	black 9005			white 9010			* 01	* 02
	silver			gold			* 04	* 05



white



black

Create my unique code!

3104 - 00 - ~ - ▲ - ● - ◆ - * - ☾ - 00

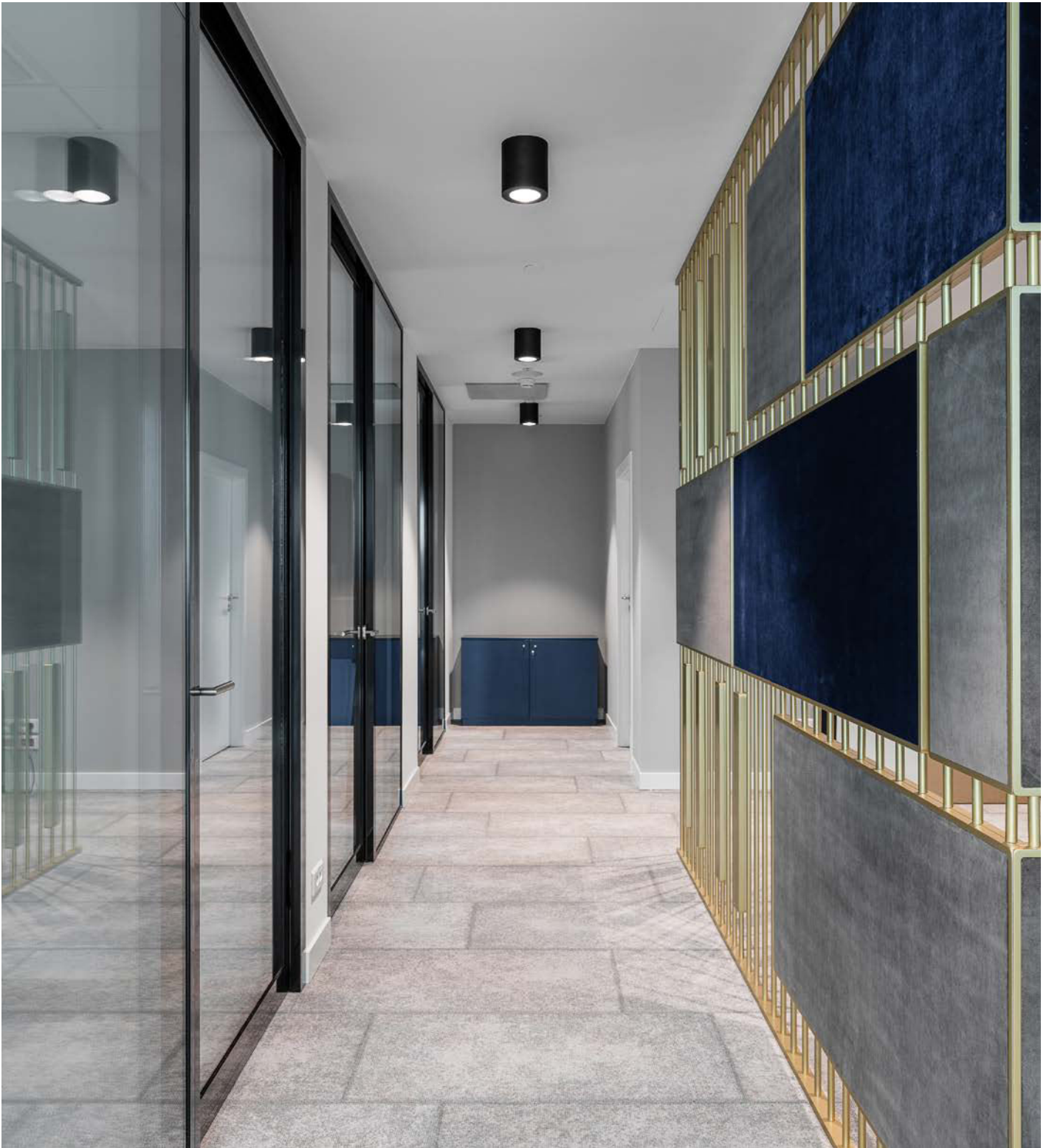

MIDEUROPA BITCREATIVE

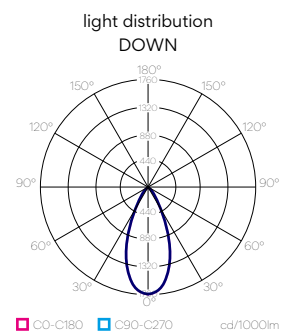
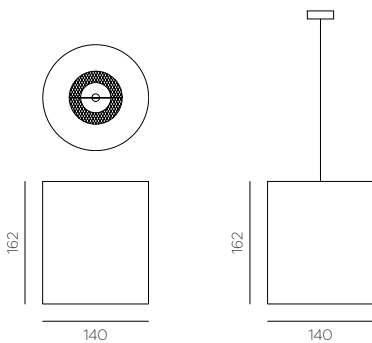

Acoustics



EOS POLAND TRZOP ARCHITEKCI



95
PET
BOTTLES

PET THICKNESS
12 mm

up to
3.60 m²
ACOUSTIC
SURFACE



Screen

EN Screen is a hanging office divider. It can be easily hung in various places throughout your workspace, making it a flexible solution to adapt to changing office layouts. Make Screen Glow uniquely yours! Screen Glow can be personalized with various designs or motivational notes using a plotter machine, adding a touch of inspiration and creativity to your workspace.

DE Screen ist ein hängender Raumtrenner. Er kann leicht an verschiedenen Stellen in Ihrem Arbeitsbereich aufgehängt werden und ist somit eine flexible Lösung, die sich an wechselnde Büroaufteilungen anpassen lässt. Kreieren Sie selbst ein Einzigartiges Produkt! Screen Glow kann mit Hilfe eines Plotters mit verschiedenen Motiven oder motivierenden Sprüchen personalisiert werden, um Ihrem Arbeitsplatz einen Hauch von Inspiration und Kreativität zu verleihen.

Example

Screen	pattern 01
↑	↑
9101 - 00 - 01 - archi1201	
↓	↓
one size	ARCHI felt color 1201 Cloud

Quickinfo

	Screen
size	900×2065×12
fabric color	ARCHI felt ecoPET color palette ◆ archixxx archixxx – choose color from page 266

Screen Glow – see page 108

Create my unique code!

9101 - 00 - x - ◆

01

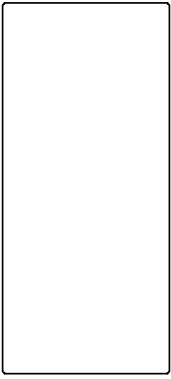

02

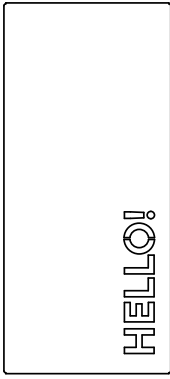

03

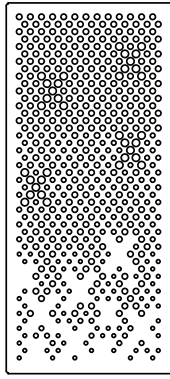

04

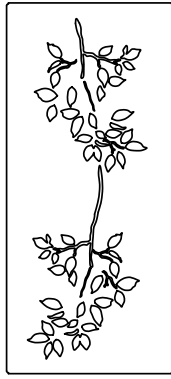

05

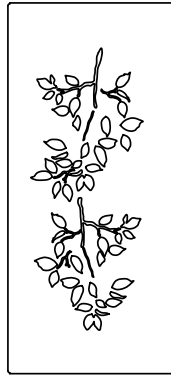

06

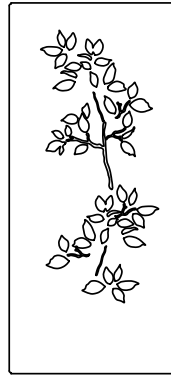

07

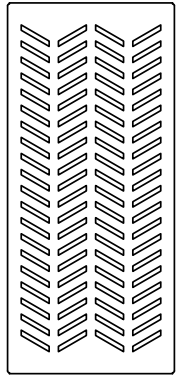

08

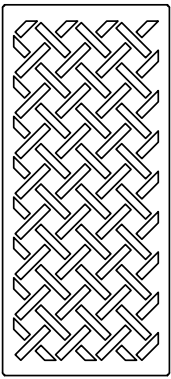

09

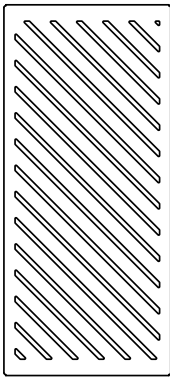

10

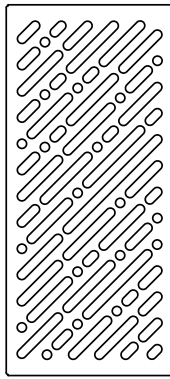

11

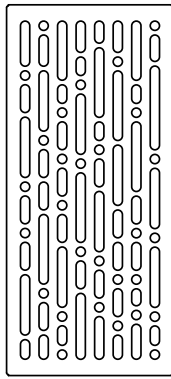

12

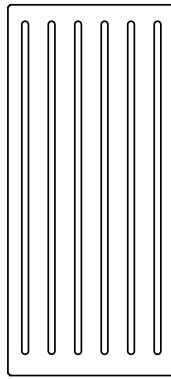

13

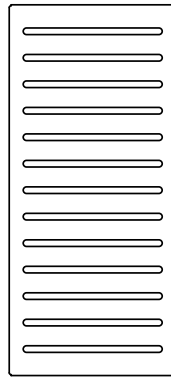

14

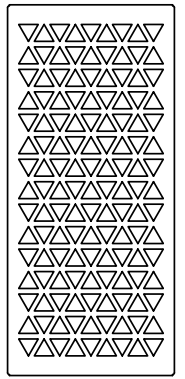

15

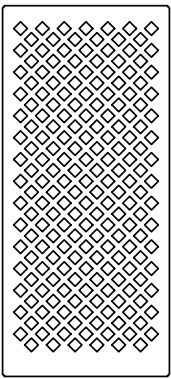

16

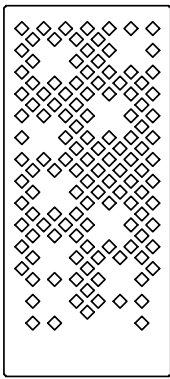

17

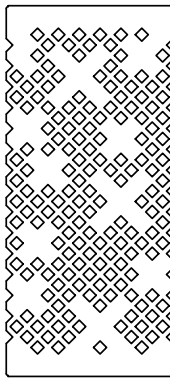

18

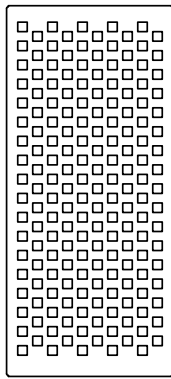

19

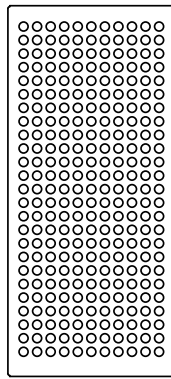

20

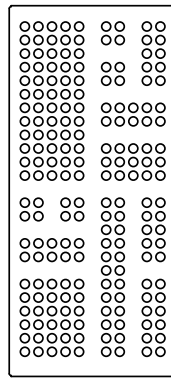

21

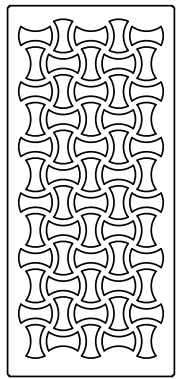

99

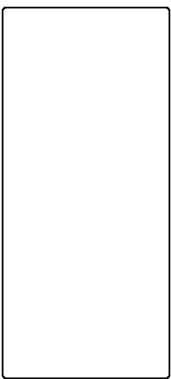

Your Custom Project

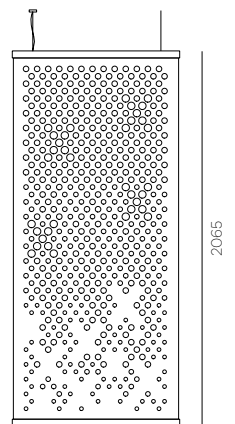

900

2065

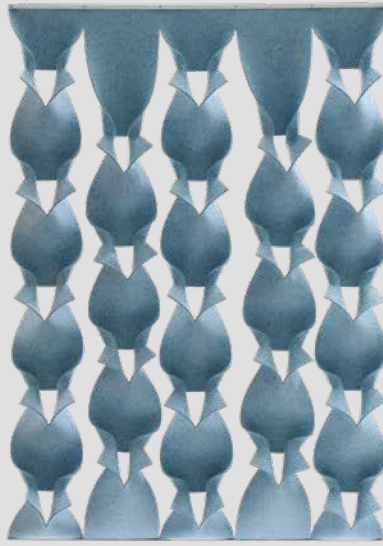

Twist

EN Twist is a suspended divider crafted from high-quality wool felt. Its design draws inspiration from the classic Polish pastry twists, known as angel wing cookies. This divider takes the shape of charming little bow ties, lending a uniquely contemporary aesthetic.

Noteworthy attributes include its excellent sound-absorbing properties and a wide range of customizable color options, effortlessly elevating the visual appeal of any space.

The Twist was designed in cooperation with Anna Spakowska.

DE Twist ist ein schwebender Raumteiler, der aus hochwertigem Wollfilz hergestellt wird. Sein Design ist inspiriert von den klassischen, slawischen Gebäck- faworek, dass als Schürzkuchen bekannt ist. Dieser Raumteiler hat die Form einer charmanten kleinen Schleife, was ihm eine einzigartig moderne Ästhetik verleiht.

Zu den bemerkenswerten Attributen gehören seine hervorragenden schallabsorbierenden Eigenschaften und eine breite Palette von anpassbaren Farboptionen, die mühelos die visuelle Attraktivität jedes Raumes erhöhen.

Der Twist wurde in Zusammenarbeit mit bekannte Art Künstlerin, Anna Spakowska entworfen.

Example

Twist no pattern
 ↑ ↑
 9110 - 01 - 00 - FW2318
 ↓ ↓
 size 01 Flexxica wool
 felt color 2318

Quickinfo

size	800×1600	■ 01
	1000×1600	■ 02
	1200×1600	■ 03
	1400×1600	■ 04
	1600×1600	■ 05
	800×1900	■ 06
	1000×1900	■ 07
	1200×1900	■ 08
	1400×1900	■ 09
	1600×1900	■ 10
fabric color	Flexxica wool felt color palette ◆ FWxxxx FWxxxx – choose color from page 267	

Create my unique code!

9110 - ■ - 00 - ◆



01

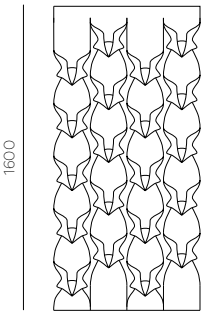

800

02

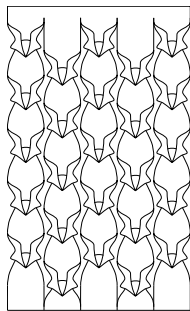

1000

03

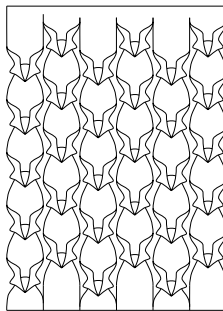

1200

04

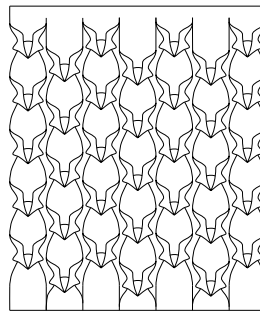

1400

05

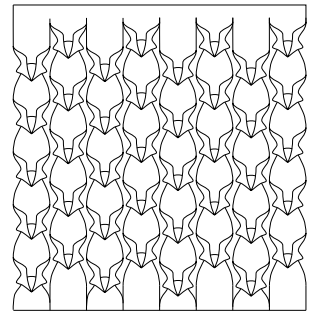

1600

06

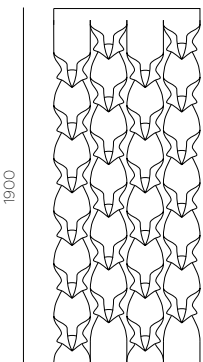

800

07

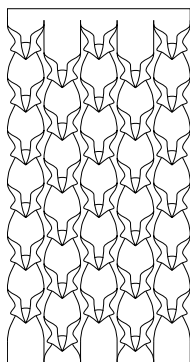

1000

08

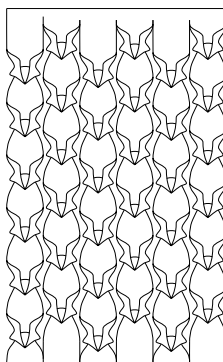

1200

09

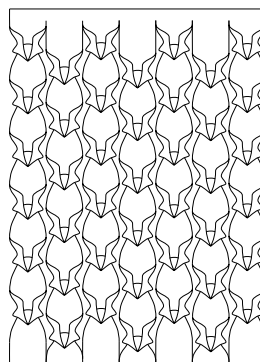

1400

10

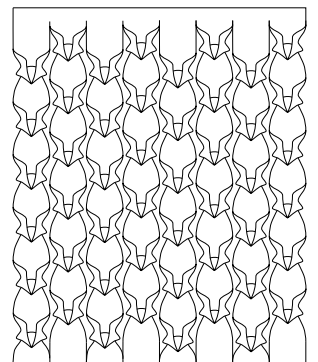

1600



Wall Tiles

EN Wall Panels Tiles Series is the perfect solution for offices seeking enhanced acoustics while maintaining a sleek aesthetic. These tiles, designed in geometric repetitive patterns, seamlessly blend style, functionality, and eco-consciousness. Crafted from PET material they offer outstanding ability to reduce reverberation and minimize noise levels and commit to delivering a superior acoustic experience. The adaptability of PET thickness ensures a tailored fit to meet the unique demands of project's acoustic requirements.

Easy to install Wall Panels Tiles Series instantly transform any space into a visually captivating masterpiece. A diverse selection of patterns offers a creative freedom to craft an ambiance that mirrors your distinct style and preferences.

DE Wall Panels Tiles Series ist die perfekte Lösung für Büros, die eine verbesserte Akustik bei gleichzeitiger Beibehaltung einer eleganten Ästhetik wünschen. Diese in geometrischen, sich wiederholenden Mustern gestalteten Fliesen vereinen nahtlos Stil, Funktionalität und Umweltbewusstsein. Sie werden aus PET-Material hergestellt und bieten eine hervorragende Fähigkeit zur Reduzierung des Nachhalls und zur Minimierung des Geräuschpegels und verpflichten sich, ein hervorragendes akustisches Erlebnis zu bieten. Die Anpassungsfähigkeit der PET-Stärke gewährleistet eine maßgeschneiderte Passform, um die einzigartigen Anforderungen der akustischen Anforderungen des Projekts zu erfüllen.

Die einfach zu installierenden Wandpaneele der Tiles Series verwandeln jeden Raum in ein visuell fesselndes Meisterwerk. Eine vielfältige Auswahl an Mustern bietet kreative Freiheit, um ein Ambiente zu schaffen, das Ihren individuellen Stil und Ihre Vorlieben widerspiegelt.

Example

Wall Tiles flat
 ↑ ↑
 9104 - 01 - 01 - archi1201
 ↓ ↓
 Square ARCHI felt color
 1201 Cloud

Quickinfo

	Square ■ 01	Rectangle ■ 02	Arc ■ 03	Deltoid ■ 04	Circle ■ 05
size	395×395	795×395	395×395	400×346	Ø395
thickness	minimum 12 mm				
fabric color	ARCHI felt ecoPET color palette ◆ archixxx archixxx – choose color from page 266				

Create my unique code!

9104 - ■ - x - ◆

Square

Rectangle

Arc

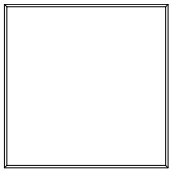

FLAT
01

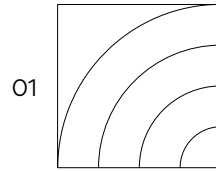
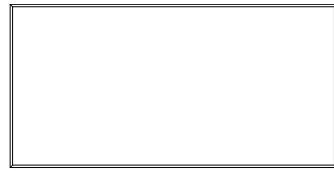

01

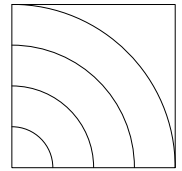

02

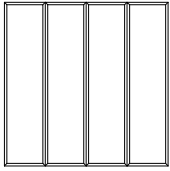

STRAPS
02

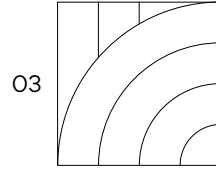
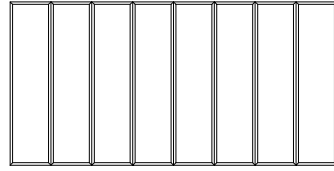

03

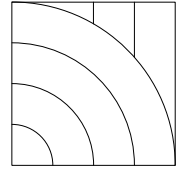

04

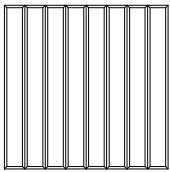

STRIPES
03

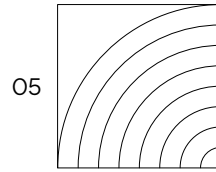
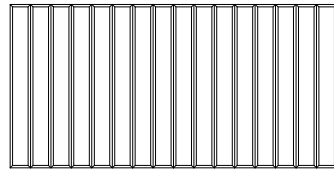

05

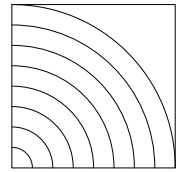

06

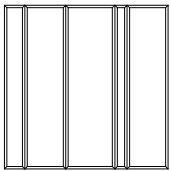

LINES
04

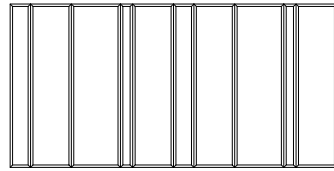

395

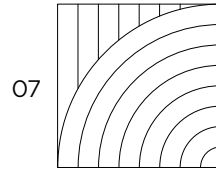

07

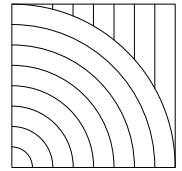

08

395

395

795

395

Deltoid

Circle

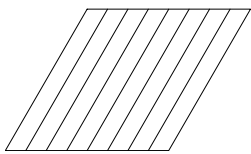

01

STRIPES

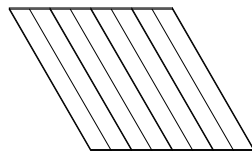

02

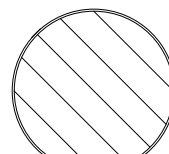

400

STRAPS
01

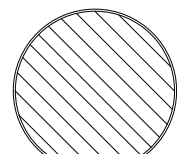

STRIPES
02

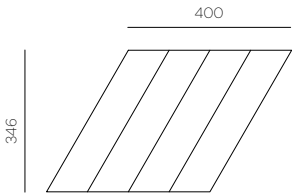

03

STRAPS

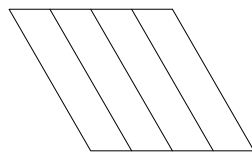

04

↓
THICKNESS
12 mm
↑



Wall Slabs

EN The Wall Panels Slabs Series distinguishes itself with larger dimensions, making them integral components of a comprehensive, expansive design. Effortlessly installed, these slabs easily transform any space into a visually captivating masterpiece. With a range of patterns to choose from, they offer creative freedom to shape an ambiance that perfectly reflects your unique style and preferences. The adaptability in PET thickness guarantees a bespoke fit, catering to the specific requirements of every project.

These panels are engineered to effectively dampen sound waves, creating a tranquil environment that promotes focus, productivity, and comfort. With their outstanding ability to reduce reverberation and minimize noise levels, the Wall Panels Slabs Series stands as a commitment to delivering a superior acoustic experience.

DE Die Serie Wall Panels Slabs zeichnet sich durch größere Abmessungen aus, die sie zu einem integralen Bestandteil eines umfassenden, weitläufigen Designs machen. Diese Platten lassen sich mühelos verlegen und verwandeln jeden Raum in ein visuell fesselndes Meisterwerk. Mit einer Reihe von Mustern, die zur Auswahl stehen, bieten sie kreative Freiheit, um ein Ambiente zu gestalten, das Ihren einzigartigen Stil und Ihre Vorlieben perfekt widerspiegelt. Die Anpassungsfähigkeit der PET-Stärke garantiert eine maßgeschneiderte Passform, die den spezifischen Anforderungen eines jeden Projekts gerecht wird.

Diese Paneele sind so konzipiert, dass sie Schallwellen effektiv dämpfen und eine ruhige Umgebung schaffen, die Konzentration, Produktivität und Komfort fördert. Mit ihrer herausragenden Fähigkeit, den Nachhall zu reduzieren und den Geräuschpegel zu minimieren, steht die Wall Panels Slabs Serie für ein hervorragendes akustisches Erlebnis.

Example

Wall Slabs pattern 01
↑ ↑
9105 - 01 - 01 - archi1201
↓ ↓
size 01 ARCHI felt color
 1201 Cloud

Quickinfo

size	1195×395	■ 01
	1195×595	■ 02
	1395×395	■ 03
	1395×595	■ 04
pattern	slabs 1	✕ 01
	slabs 2	✕ 02
	slabs 3	✕ 03
	slabs 4	✕ 04
	slabs 5	✕ 05
	slabs 6	✕ 06
	slabs 7	✕ 07
thickness	12 mm	
	on request: thicker PET	
fabric color	ARCHI felt ecoPET color palette	◆ archixxx
	archixxx – choose color from page 266	

Create my unique code!

9105 - ■ - ✕ - ◆

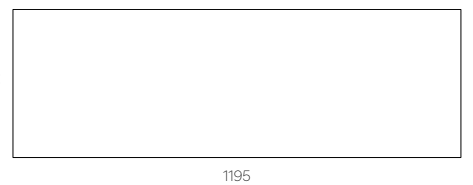
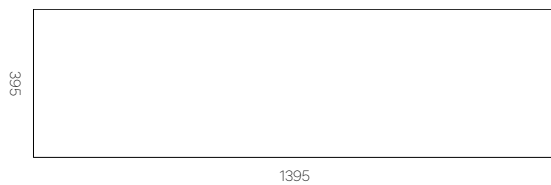
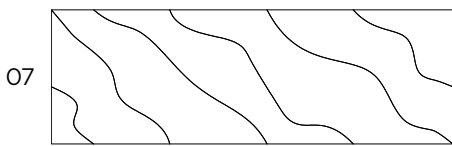
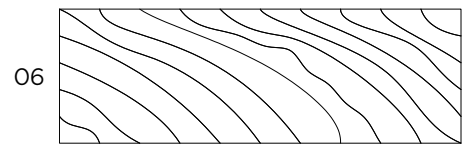
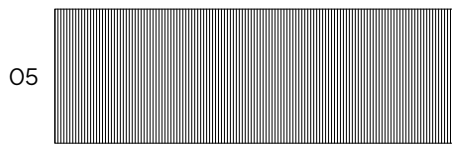
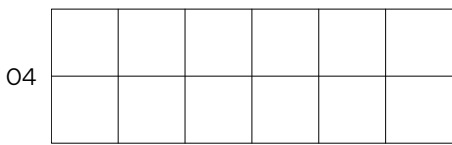
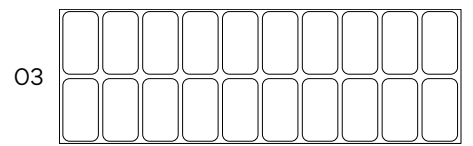
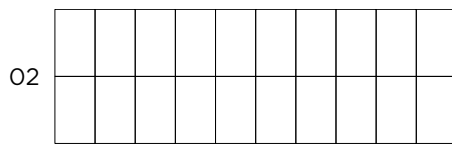
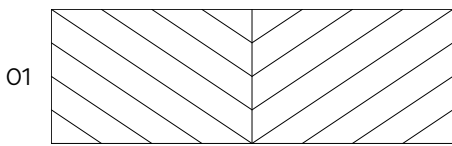

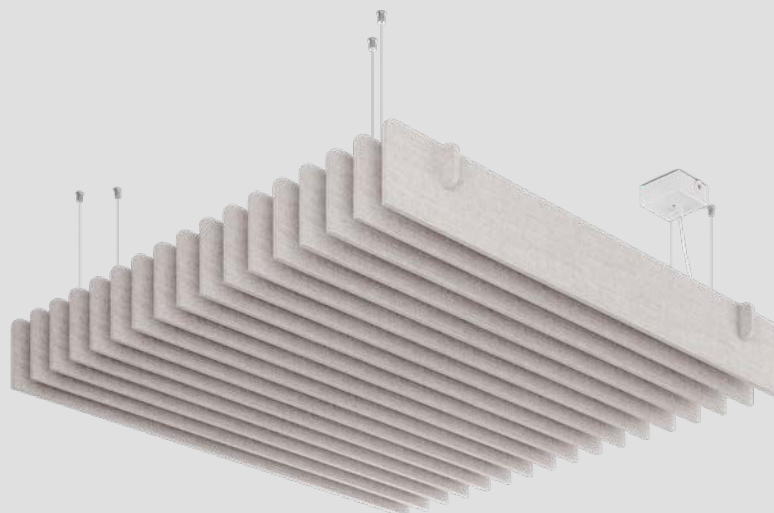
176
PET
BOTTLESup to
6.66m²
ACOUSTIC
SURFACE

Echo Baffles

EN Echo baffles are acoustic panels designed to enhance the acoustics within an office environment. These panels are strategically installed on the ceiling to effectively manage sound levels and create a more conducive auditory atmosphere.

The distinctive construction of these panels consists of vertical acoustic baffles that play a pivotal role in sound absorption. By strategically positioning these baffles, the panels effectively capture and dampen sound waves, thereby reducing noise levels within the office space. The space between the baffles acts as an additional sound absorber, creating a multi-layered approach to acoustic management. As sound waves encounter the baffles, they are absorbed and diffused, preventing excessive reverberation and echo.

DE Echo Baffles sind Akustikpaneele, die die Akustik in einer Büroumgebung verbessern. Diese Paneele werden strategisch an der Decke installiert, um den Schallpegel effektiv zu steuern und eine bessere akustische Atmosphäre zu schaffen.

Die charakteristische Konstruktion dieser Paneele besteht aus vertikalen akustischen Baffeln, die eine entscheidende Rolle bei der Schallabsorption spielen. Durch die strategische Positionierung dieser Baffeln fangen die Paneele effektiv Schallwellen ein und dämpfen sie, wodurch der Geräuschpegel im Büroraum reduziert wird. Der Raum zwischen den Baffeln wirkt als zusätzlicher Schallabsorber und schafft so einen mehrschichtigen Ansatz für das Akustikmanagement. Wenn Schallwellen auf die Baffeln treffen, werden sie absorbiert und gestreut, wodurch übermäßiger Nachhall und Echo verhindert werden.

Example

Echo Baffles	no pattern
↑	↑
9106 - 01 - 00 - archi1201	
↓	↓
Square A	ARCHI felt color 1201 Cloud

Quickinfo

	Square A ■ 01	Square B ■ 02
size	1195×1195×120	1195×1195×160
thickness	12 mm	12 mm
fabric color	ARCHI felt ecoPET color palette ◆ archixxx archixxx – choose color from page 266	
	on request: Echo Baffles can be customized with linear luminaries. See page 90.	

Create my unique code!

9106 - ■ - 00 - ◆

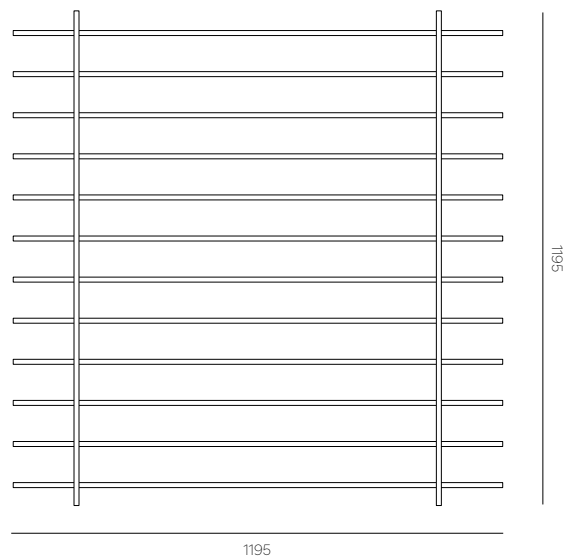
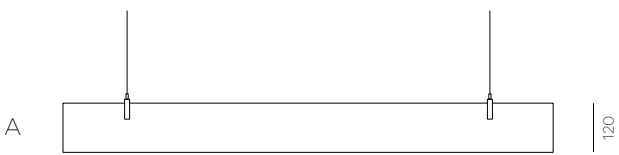



Hash

EN Hash is a suspended ceiling system designed to deliver efficient sound damping. Consisting of 14 ecoPET large baffles arranged in a perpendicular manner, intersecting with each other, the end construction forms a checkered dome that extends from the ceiling. It can take the shape of either a circle or square, allowing air to circulate between the components for enhanced sound absorption. This pendant ceiling system was meticulously crafted to diminish sound levels in expansive office spaces and emanates a commanding presence, captivating observers with its dynamic allure.

DE Hash ist ein System für abgehängte Decken, das für eine effiziente Schalldämpfung sorgt. Es besteht aus 14 großen ecoPET-Kulissen, die senkrecht angeordnet sind und sich überkreuzen. Die Endkonstruktion bildet eine schachbrettartige Kuppel, die von der Decke absteht. Sie kann die Form eines Kreises oder eines Quadrats annehmen, so dass die Luft zwischen den Komponenten zirkulieren kann, um die Schallabsorption zu verbessern. Dieses hängende Deckensystem wurde sorgfältig entwickelt, um den Schallpegel in großen Büroräumen zu senken. Es strahlt eine beeindruckende Präsenz aus und fesselt den Betrachter durch seine dynamische Ausstrahlung.

Example

Hash	no pattern
↑	↑
9111 - 01 - 00 - archi1201	
↓	↓
size 01	ARCHI felt color 1201 Cloud

Quickinfo

	Hash Round	Hash Square
size	Ø1200×293 ■ 01 Ø1600×300 ■ 02	1200×1200×300 ■ 03 1600×1600×300 ■ 04
fabric color	ARCHI felt ecoPET color palette ◆ archixxx archixxx – choose color from page 266	

Create my unique code!

9111 - ■ - 00 - ◆



Hash Round O1

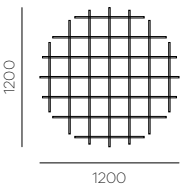
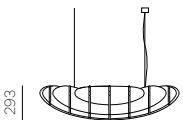

Hash Round O2

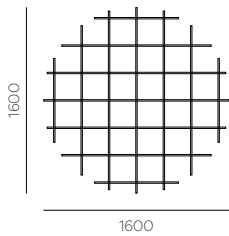
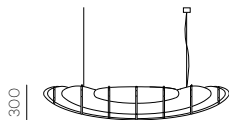

Hash Square O1

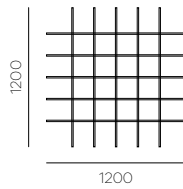
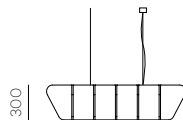

Hash Square O2

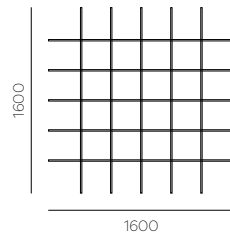
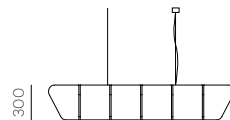

↓
THICKNESS
24 mm
↑



Focus

EN Focus Desk Divider was designed to create more privacy and focused atmosphere in an open space office. It reduces ambient noise and fosters deep concentration. Easy installation and multifunctional use make it an essential addition to your workspace. Choose from four unique patterns to match your personal style.

DE Focus Desk Divider wurde entwickelt, um mehr Privatsphäre und eine konzentrierte Atmosphäre in einem Großraumbüro zu schaffen. Er reduziert den Umgebungslärm und fördert die Konzentration. Die einfache Installation und der multifunktionale Einsatz machen ihn zu einer unverzichtbaren Ergänzung Ihres Arbeitsplatzes. Wählen Sie aus vier einzigartigen Mustern, die zu Ihrem persönlichen Stil passen.

Quickinfo

size	1000×340×24	■ 01
	1200×340×24	■ 02
	1400×340×24	■ 03
	1600×340×24	■ 04
	1800×340×24	■ 05
	2000×340×24	■ 06
	1000×480×24	■ 07
	1200×480×24	■ 08
	1400×480×24	■ 09
	1600×480×24	■ 10
	1800×480×24	■ 11
	2000×480×24	■ 12
	1000×600×24	■ 13
	1200×600×24	■ 14
	1400×600×24	■ 15
	1600×600×24	■ 16
	1800×600×24	■ 17
	2000×600×24	■ 18
patterns	flat	✕ 01
	wings	✕ 02
	stripes	✕ 03
	waterfall	✕ 04
	on request:	custom project
thickness	24 mm	
fabric color	ARCHI felt ecoPET color palette ◆ archixxx archixxx – choose color from page 266	

Example

Focus pattern
↑ wings
9107 - 01 - 02 - archi1201
↓ ↓
size 01 ARCHI felt color
 1201 Cloud

Create my unique code!

9107 - ■ - ✕ - ◆

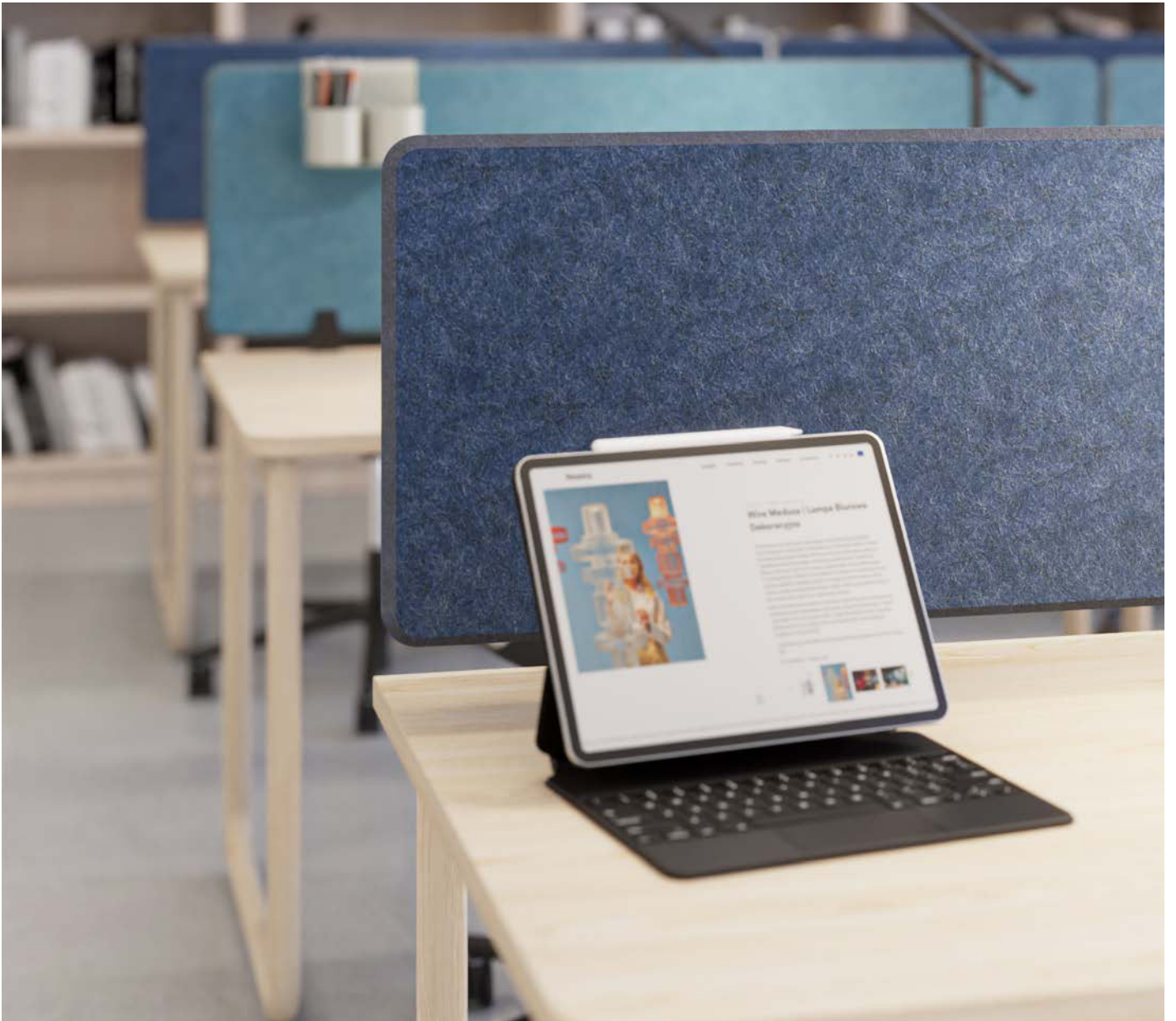

O1 flat

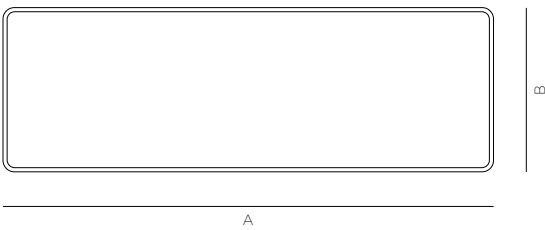

O3 stripes

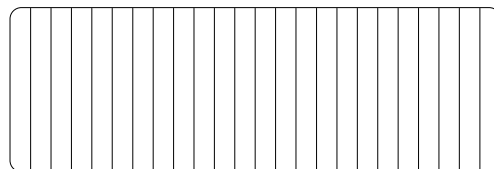

O2 wings

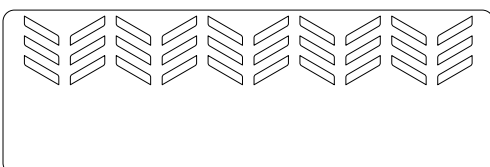

O4 waterfall

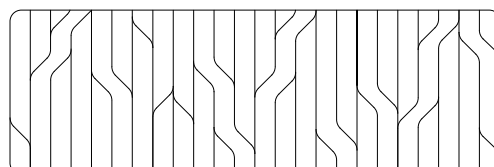

↓
PET THICKNESS
24 mm
↑

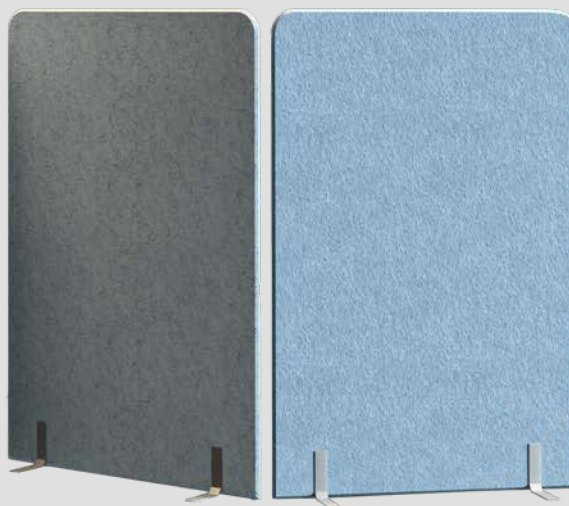

Flexx Wall

EN Flexx Wall is a versatile solution for dynamic workspace division. Crafted from ecpPET acoustic material provides a quieter environment, fostering concentration and productivity.

With a range of customizable patterns and colors it enhances productivity and aesthetics. It's easy installation and reconfiguration process make it a hassle-free addition to your workspace.

DE Flexx Wall ist eine vielseitige Lösung für die dynamische Aufteilung von Arbeitsbereichen. Das akustische ecpPET-Material sorgt für eine ruhigere Umgebung und fördert die Konzentration und Produktivität.

Mit einer Reihe von anpassbaren Mustern und Farben steigert sie die Produktivität und Ästhetik. Die einfache Installation und Neukonfiguration machen es zu einer problemlosen Ergänzung Ihres Arbeitsbereichs.

Quickinfo

size	700×1200×24	■ 01
	700×1400×24	■ 02
	700×1600×24	■ 03
	800×1200×24	■ 04
	800×1400×24	■ 05
	800×1600×24	■ 06
	900×1200×24	■ 07
	900×1400×24	■ 08
	900×1600×24	■ 09
	1000×1200×24	■ 10
	1000×1400×24	■ 11
	1000×1600×24	■ 12
patterns	flat	✕ 01
	stripes	✕ 02
	waterfall	✕ 03
	on request:	custom project
thickness		24 mm
	on request:	thicker PET
fabric color	ARCHI felt ecoPET color palette ◆ archixxx archixxx – choose color from page 266	

Example

Flexx Wall	pattern lines
↑	↑
9108 - 01 - 02 - archi1201	
↓	↓
size 01	ARCHI felt color 1201 Cloud

Create my unique code!

9108 - ■ - ✕ - ◆



O1 flat

O2 stripes

O3 waterfall

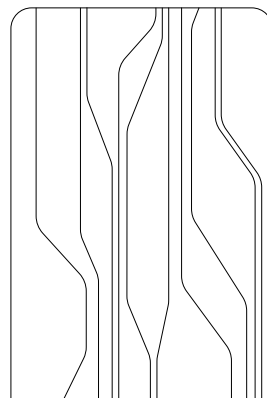
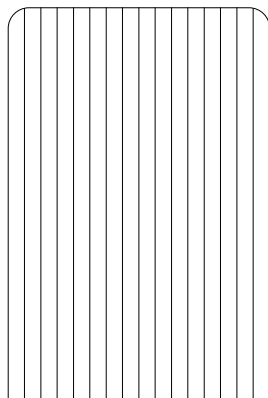
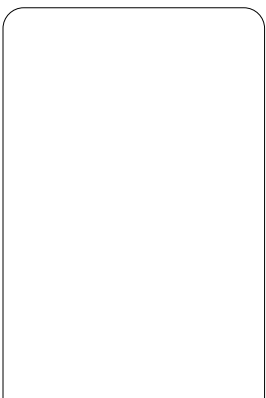

A



Echo Island

EN Echo Island Acoustic Ceiling Panel is acoustic solution crafted to revolutionize the auditory experience in office environments. These thoughtfully designed acoustic panels come in both round and square shapes, offering a versatile and visually appealing addition to any workspace. These panels effectively mitigate echoes and reverberations, ensuring a more balanced and comfortable auditory environment. Their robust construction from 36 mm ecoPET ensures reliable solution for long-term acoustic enhancement.

DE Echo Island Acoustic Ceiling Panel ist eine akustische Lösung, die das Hörerlebnis in Büroumgebungen revolutionieren soll. Diese durchdacht konzipierten Akustikpaneele sind sowohl in runder als auch in quadratischer Form erhältlich und bieten eine vielseitige und optisch ansprechende Ergänzung für jeden Arbeitsbereich. Die Paneele dämpfen effektiv Echos und Nachhall und sorgen so für eine ausgewogene und angenehme akustische Umgebung. Ihre robuste Konstruktion aus 36 mm ecoPET gewährleistet eine zuverlässige Lösung für eine langfristige akustische Verbesserung.

Example

Echo Island	no pattern
↑	↑
9109 - 01 - 00 - archi1201	
↓	↓
01 circle	ARCHI felt color 1201 Cloud

Quickinfo

	Circle	■ 01	Square	■ 02
size	Ø1150		1150×1150	
thickness	36 mm			
fabric color	ARCHI felt ecoPET color palette ◆ archixxx archixxx – choose color from page 266			

Create my unique code!

9109 - ■ - 00 - ◆



Circle

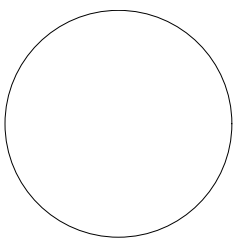

1150

Square

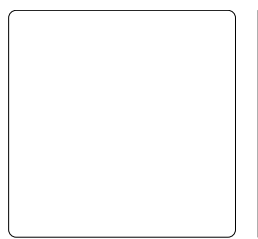

1150

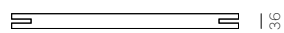
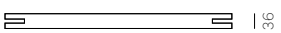



Zen Garden

EN Zen Garden is an innovative product that combines the functionality of a pot with advanced acoustic properties. It is an ideal solution for offices that wish to create a harmonious, calm and efficient work space in combination with office plants. Its unique design and simplicity of form add a sophisticated touch to offices, bringing harmony and tranquility to the work environment. The size of the flowerpot has been appropriately adapted to office desks and shelves, allowing it to be easily integrated into various spaces.

DE Zen Garden ist ein innovatives Produkt, das die Funktionalität eines Topfes mit fortschrittlichen akustischen Eigenschaften kombiniert. Es ist eine ideale Lösung für Büros, die in Kombination mit Büropflanzen einen harmonischen, ruhigen und effizienten Arbeitsbereich schaffen wollen. Sein einzigartiges Design und seine schlichte Form verleihen dem Büro eine raffinierte Note und bringen Harmonie und Ruhe in die Arbeitsumgebung. Die Größe des Blumentopfs wurde an die Größe von Schreibtischen und Regalen angepasst, so dass er sich leicht in verschiedene Räume integrieren lässt.

Example

Zen Garden no pattern
 ↑ ↑
 9100 - 01 - 00 - archi1201
 ↓ ↓
 size S ARCHI felt color
 1201 Cloud

Quickinfo

	Zen Garden S ■ 01	Zen Garden M ■ 02
size	Ø510×530	Ø390×700
fabric color	ARCHI felt ecoPET color palette ◆ archixxx archixxx – choose color from page 266	

Create my unique code!

9100 - ■ - 00 - ◆



S

M

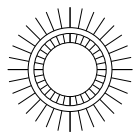
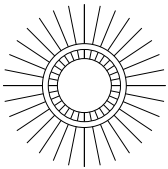

260

260

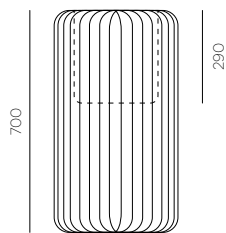
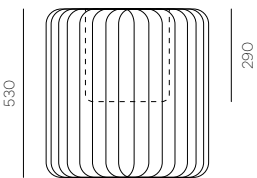

530

290

700

290

510

390



Tower

EN Acoustic Tower, the versatile soundproofing panel that effortlessly enhances the interior design of your office while serving multiple functions. Tower goes beyond its primary role as a soundproofing solution and offers you the flexibility to utilize it as an information board or a convenient space for attaching notes.

DE Acoustic Tower, das vielseitige Schallschutzpaneel, das die Inneneinrichtung Ihres Büros mühelos aufwertet und gleichzeitig mehrere Funktionen erfüllt. Tower geht über seine primäre Rolle als Schallschutzlösung hinaus und bietet Ihnen die Flexibilität, ihn als Informationstafel oder als praktischen Platz zum Anbringen von Notizen zu nutzen.

Example

Tower	no pattern
↑	↑
9103 - 00 - 00 - archi1201	
↓	↓
one size	ARCHI felt color 1201 Cloud

Quickinfo

	Tower
size	2013×500×500
fabric color	ARCHI felt ecoPET color palette ◆ archixxx archixxx – choose color from page 266

Create my unique code!

9103 - 00 - 00 - ◆

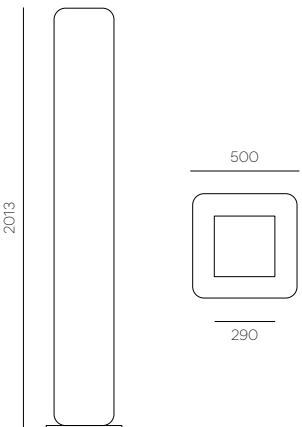



Case

EN Case is an office organizer designed to carry office items, catalogues, and other office essentials. Crafted from recycled materials derived from PET bottles, this case embodies both functionality and sustainability. Whether you're working in a traditional office or embracing the flexibility of hot desking, Case is the perfect companion for your everyday office needs. Stay organized, reduce your environmental footprint, and elevate your office experience with Case. Make a conscious choice for both your productivity and the planet. Order the flexica Case for your team choosing from 2 available sizes and a range of vibrant colors to match your office aesthetics.

DE Case ist ein Büro-Organizer für Büroartikel, Kataloge und andere wichtige Büroartikel. Gefertigt aus recycelten Materialien, die aus PET-Flaschen gewonnen wurden, verkörpert dieser Koffer sowohl Funktionalität als auch Nachhaltigkeit. Egal, ob Sie in einem traditionellen Büro arbeiten oder die Flexibilität des Hot Desking nutzen, Case ist der perfekte Begleiter für Ihren Büroalltag. Bleiben Sie organisiert, reduzieren Sie Ihren ökologischen Fußabdruck und verbessern Sie Ihr Büroerlebnis mit Case. Treffen Sie eine bewusste Entscheidung für Ihre Produktivität und unseren Planeten. Bestellen Sie den flexica Case für Ihr Team und wählen Sie aus 2 verfügbaren Größen und einer Reihe von leuchtenden Farben, die zu Ihrer Büroästhetik passen.

Example

Case no
 ↑ pattern
 9102 - 01 - 00 - archi1201
 ↓ ↓
 size S ARCHI felt color
 1201 Cloud

Quickinfo

	Case S	■ 01	Case M	■ 02
size	368×185×192		368×185×272	
fabric color	ARCHI felt ecoPET color palette ◆ archixxx archixxx – choose color from page 266			

Create my unique code!

9102 - ■ - 00 - ◆

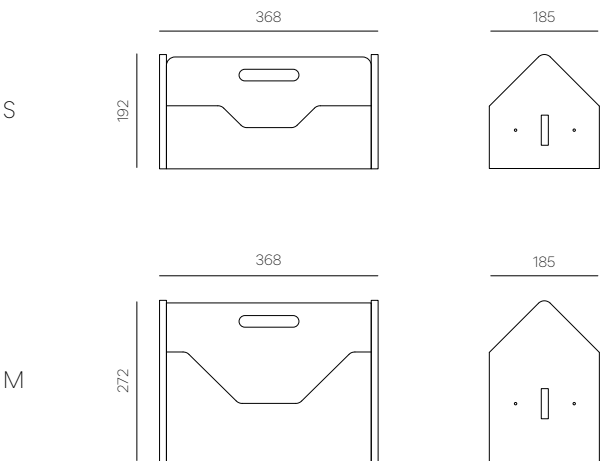

Sound absorption coefficient

felt, PET and acoustic foam

EN The sound absorption coefficient, often called as α (alpha), is a measure of how much sound energy is absorbed by a material when sound waves hit it. It is a dimensionless quantity ranging from 0 to 1, where 0 indicates complete reflection (no absorption) and 1 indicates complete absorption (no reflection).

Material with a higher sound absorption coefficient will absorb more sound energy and reflect less back into the environment. This property is crucial in office acoustics planning and the construction of acoustic panels. Different materials have different absorption characteristics at different frequencies. Generally porous materials that are used to improve acoustic conditions are more effective at absorbing high-frequency sounds compared to low-frequency sounds. Given that the most important frequency range for speech recognition is the range from 500 to 2000Hz, this is a critical consideration when embarking on acoustic planning endeavors. Thicker materials often have higher absorption coefficients, especially for lower frequencies, as sound waves have to travel through more material, so they absorb more energy compared to thinner materials.

Below charts illustrate the absorption performance across different frequencies for three materials employed in the production of Flexxica lamps: felt, PET, and acoustic foam.

DE Der Schallabsorptionskoeffizient, oft auch als α (alpha) bezeichnet, ist ein Maß dafür, wie viel Schallenergie von einem Material absorbiert wird, wenn Schallwellen auf es treffen. Er ist eine dimensionslose Größe im Bereich von 0 bis 1, wobei 0 für vollständige Reflexion (keine Absorption) und 1 für vollständige Absorption (keine Reflexion) steht.

Ein Material mit einem höheren Schallabsorptionskoeffizienten absorbiert mehr Schallenergie und reflektiert weniger in die Umgebung zurück. Diese Eigenschaft ist für die Planung der Büroakustik und die Konstruktion von Akustikplatten von entscheidender Bedeutung. Verschiedene Materialien haben unterschiedliche Absorptionseigenschaften bei verschiedenen Frequenzen. Im Allgemeinen absorbieren poröse Materialien, die zur Verbesserung der akustischen Bedingungen eingesetzt werden, hochfrequenten Schall besser als tieffrequenten Schall. Da der wichtigste Frequenzbereich für die Spracherkennung der Bereich von 500 bis 2000 Hz ist, ist dies ein entscheidender Faktor bei der Planung von akustischen Maßnahmen. Dickere Materialien haben oft einen höheren Absorptionskoeffizienten, insbesondere für niedrige Frequenzen, da die Schallwellen mehr Material durchqueren müssen und daher mehr Energie absorbieren als dünnere Materialien.

Die folgenden Diagramme veranschaulichen die Absorptionsleistung bei verschiedenen Frequenzen für drei Materialien, die bei der Herstellung von Flexxica-Lampen verwendet werden: Filz, PET und Akustikschaum.

Sound absorption coefficient FELT

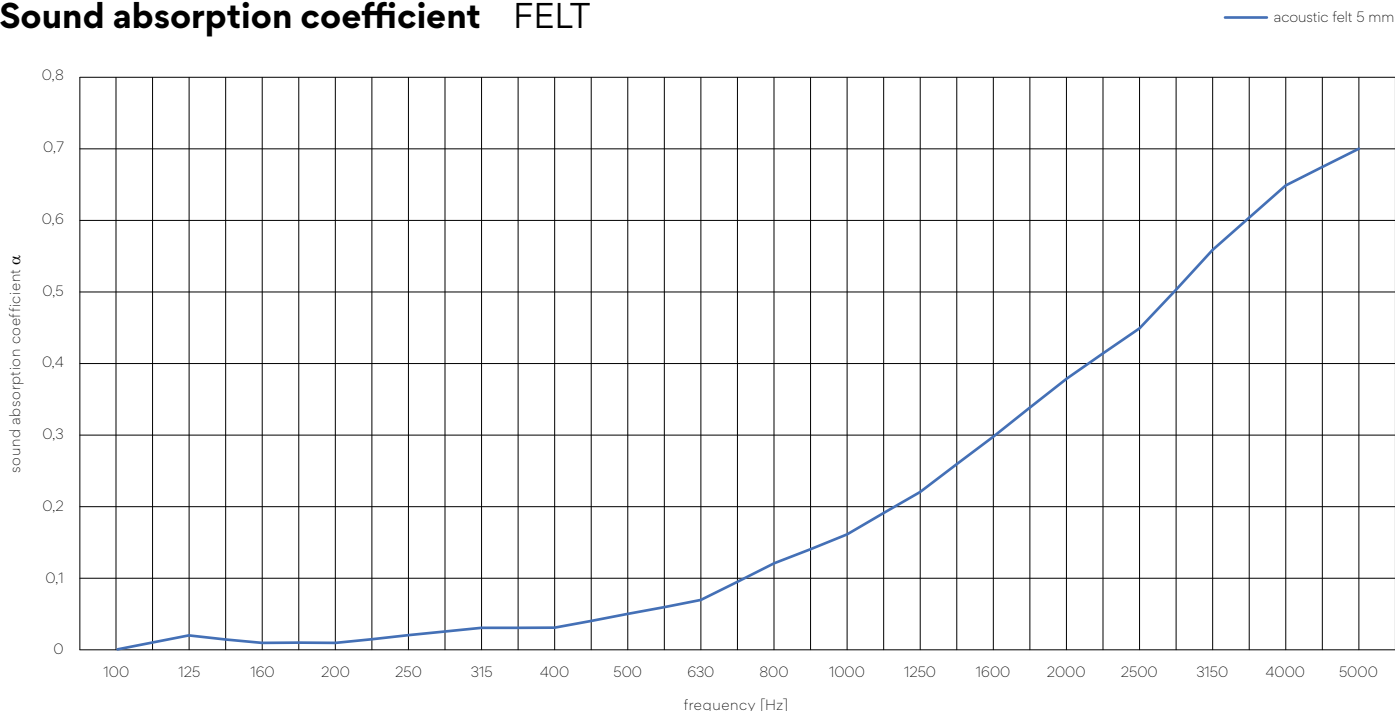

Sound absorption coefficient PET 12 mm — 12 mm no air cavity — 12 mm 50 mm air cavity — 12 mm 100 mm air cavity

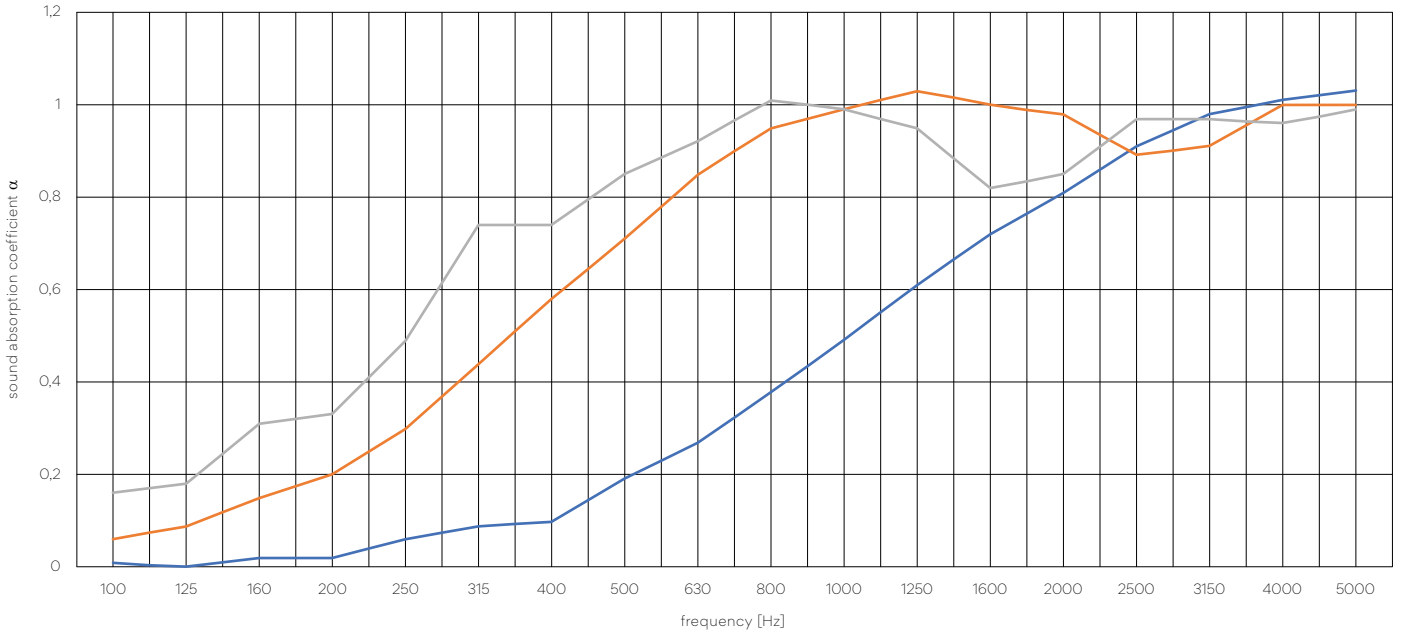

Sound absorption coefficient ACOUSTIC FOAM — 20 mm — 40 mm — 50 mm — 60 mm

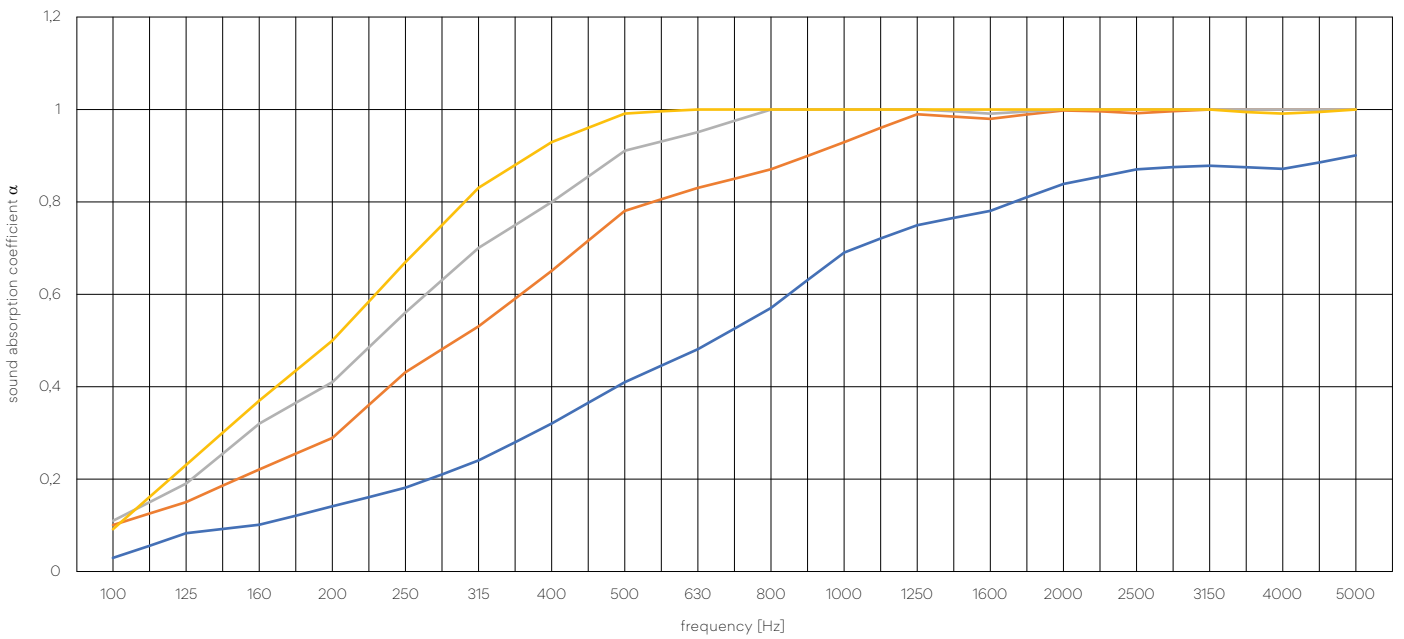

Equivalent Sound Absorption Area

EN Equivalent Sound Absorption Area (A) is a metric used in acoustics to quantify the sound-absorbing properties of an object or surface. It represents the hypothetical area of a perfectly absorbing material (which absorbs 100% of sound energy) that would provide the same level of sound absorption as the actual object or surface being evaluated. A tells how effective a particular object is at absorbing sound compared to a theoretical perfect absorber. A is expressed in square meters, square feet or sabins and is used to compare the sound absorption capabilities of different objects and surfaces. It's a useful metric in designing spaces for specific acoustic requirements, where sound & noise control is crucial, such as open plan offices or other high-volume noisy environments.

At Flexxica, our team of Acoustic Designers meticulously measures each of our acoustic luminaries to ensure they meet the exacting standards set for office rooms.

DE Die äquivalente Schallabsorptionsfläche (A) ist ein Maß, das in der Akustik zur Quantifizierung der schallabsorbierenden Eigenschaften eines Objekts oder einer Oberfläche verwendet wird. Sie stellt die hypothetische Fläche eines perfekt absorbierenden Materials (das 100% der Schallenergie absorbiert) dar, die den gleichen Schallabsorptionsgrad wie das zu bewertende Objekt oder die zu bewertende Fläche aufweisen würde. A gibt an, wie effektiv ein bestimmtes Objekt im Vergleich zu einem theoretischen perfekten Absorber Schall absorbiert. A wird in Quadratmetern, Quadratfuß oder Sabins angegeben und dient zum Vergleich der Schallabsorptionsfähigkeit verschiedener Objekte und Oberflächen. Es ist eine nützliche Kennzahl bei der Gestaltung von Räumen für spezifische akustische Anforderungen, bei denen Schall- und Geräuschkontrolle von entscheidender Bedeutung sind, wie z. B. in Großraumbüros oder in anderen lauten Umgebungen mit hohem Geräuschpegel.

Bei Flexxica misst unser Team von Akustikdesignern jede unserer Akustikleuchten akribisch aus, um sicherzustellen, dass sie die anspruchsvollen Standards für Büroräume erfüllen.

Bell

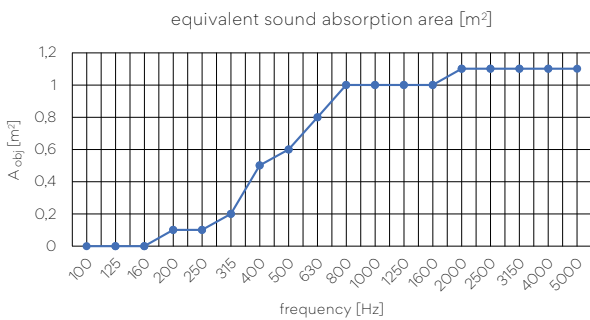

Bell Floor 2.0

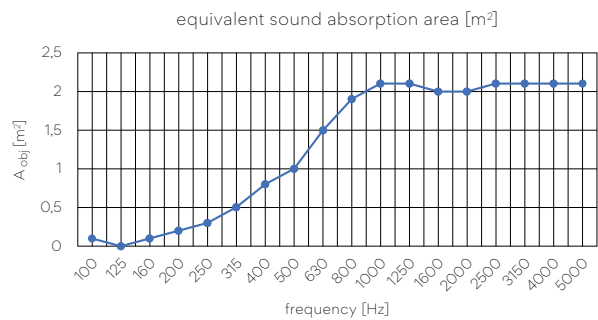

Sol

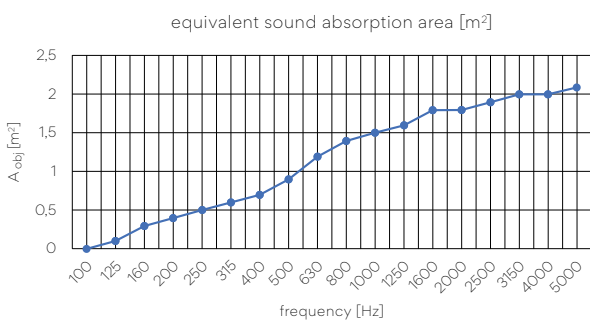

Sikt

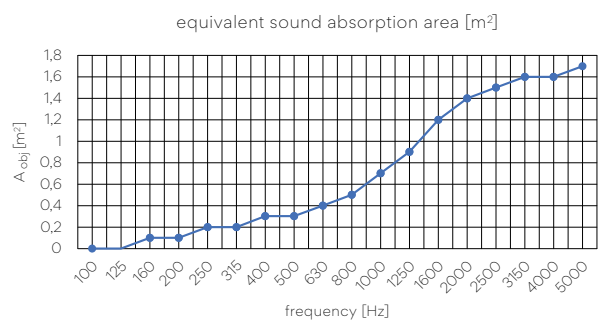

Donut

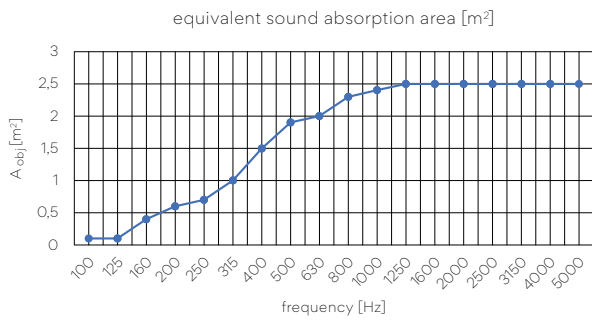

Fold

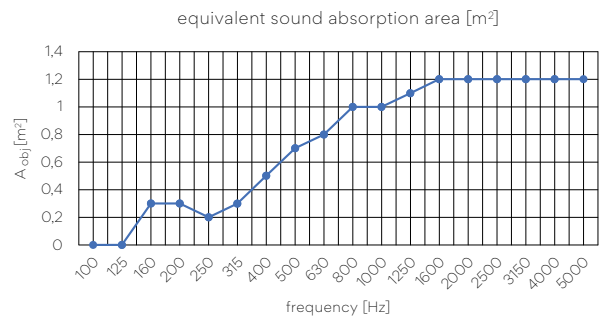

Blade 2.0

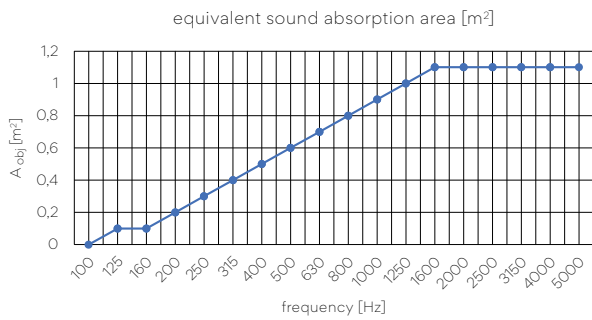

Linea

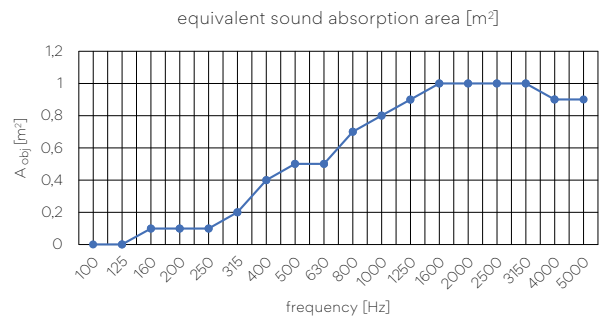

Cone PET

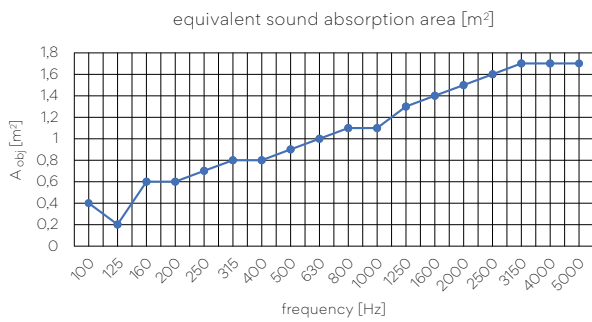

Piramid Ceiling

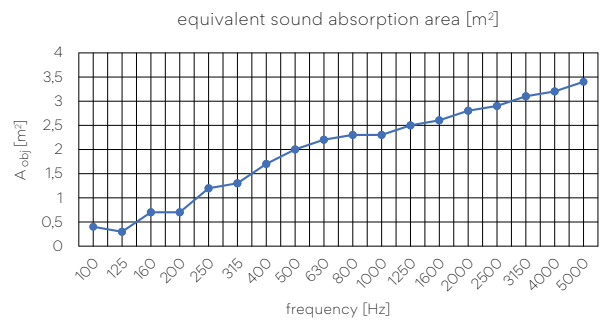

Simple Ceiling 2.0

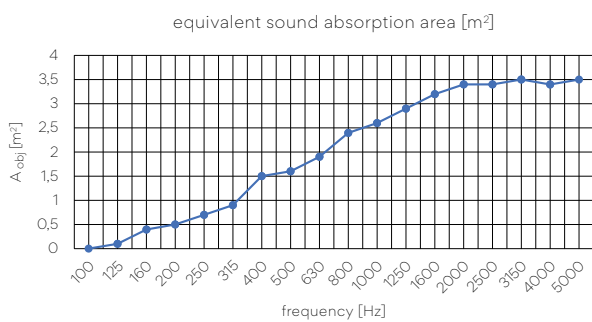

Systema Ceiling

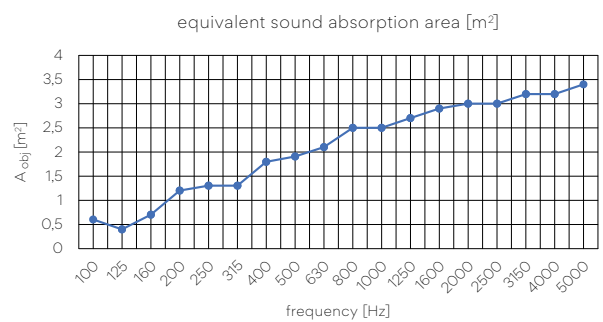

Verti Ceiling 2.0

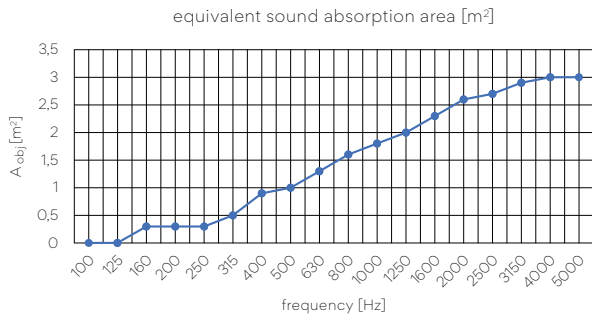

Cone

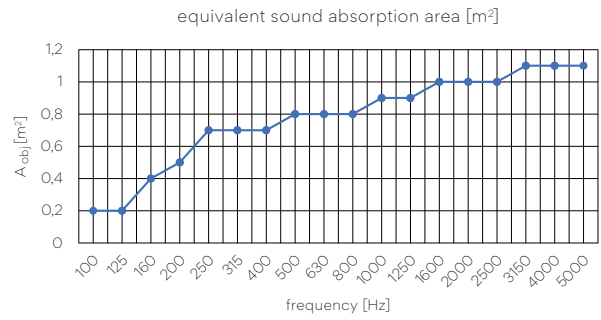

Team

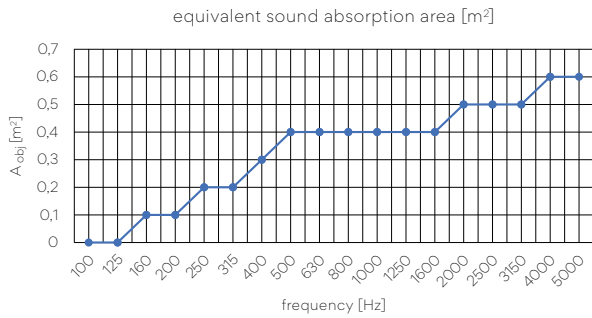

Shade

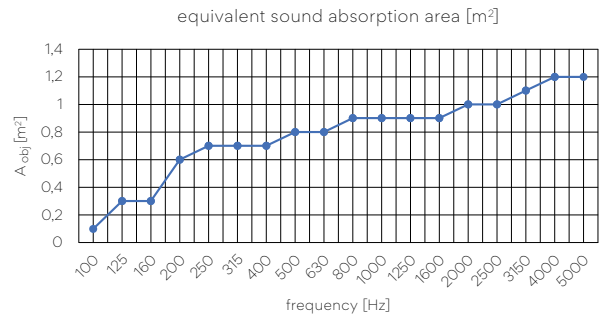

Ivy

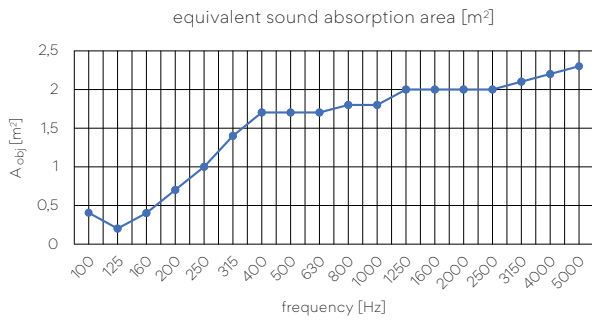

Lily

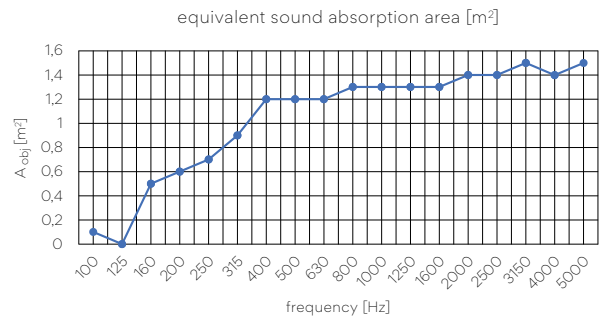

Daisy

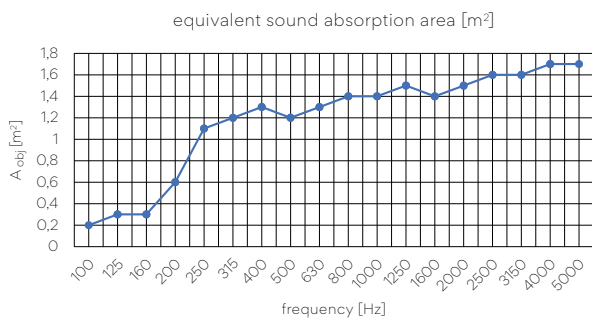

Rose

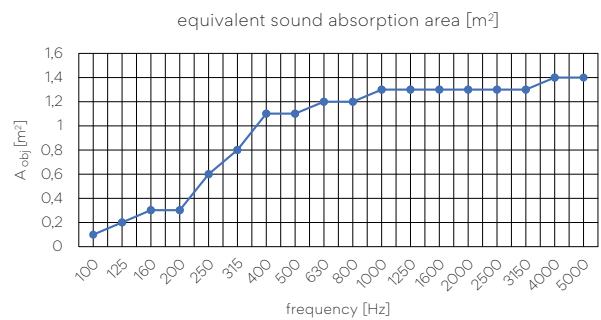

Roller

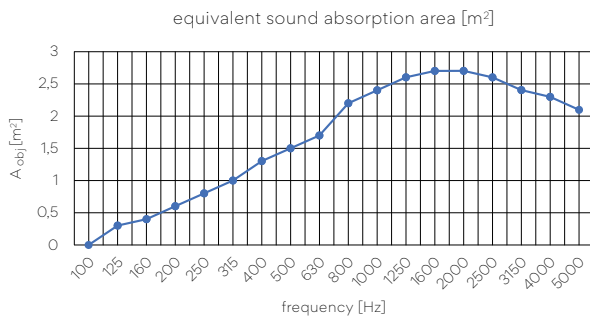

Gap Round

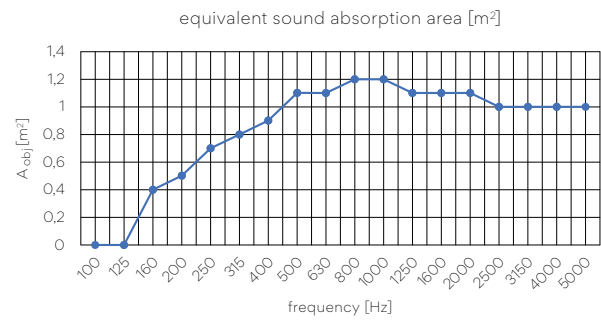

The Art and Science of Acoustic Planning

EN Acoustic planning begins by understanding the purpose of a space carefully considering factors such as materials, textures and forms. The selection of surfaces, including walls and ceilings is not driven by their appeal but also their ability to enhance sound quality.

Strategic placement of elements like curved surfaces, baffles and dividers plays a crucial role in transforming spaces into acoustically friendly environments. These elements work together harmoniously to manage waves and refine the acoustics. Each project is approached as an endeavor tailored to meet the needs and goals of the space. Acoustic planning goes beyond being a service; it becomes a journey.

At Flexxica, our journey starts with thorough consultations and precise measurements. Our expertise lies in conducting acoustic simulations and generating detailed acoustic reports. This journey culminates in the creation of a healthy acoustic space and an inviting office environment.

For consultation requests, please reach out to us at: acoustics@flexxica.com.

DE Die akustische Planung beginnt damit, dass man den Zweck eines Raumes versteht und Faktoren wie Materialien, Texturen und Formen sorgfältig berücksichtigt. Die Auswahl von Oberflächen, einschließlich Wänden und Decken, richtet sich nicht nur nach ihrer Attraktivität, sondern auch nach ihrer Fähigkeit, die Klangqualität zu verbessern.

Die strategische Platzierung von Elementen wie gebogenen Oberflächen, Baffeln und Trennwänden spielt eine entscheidende Rolle bei der Umwandlung von Räumen in akustisch freundliche Umgebungen. Diese Elemente arbeiten harmonisch zusammen, um Wellen zu managen und die Akustik zu verfeinern. Jedes Projekt wird als ein auf die Bedürfnisse und Ziele des Raums zugeschnittenes Vorhaben betrachtet. Akustische Planung ist mehr als nur eine Dienstleistung, sie ist eine Reise.

Bei Flexxica beginnt unsere Reise mit gründlichen Beratungen und präzisen Messungen. Unsere Kompetenz liegt in der Durchführung von akustischen Simulationen und der Erstellung detaillierter akustischer Berichte. Diese Reise gipfelt in der Schaffung eines gesunden akustischen Raums und einer einladenden Büroumgebung.

Für Beratungsanfragen kontaktieren Sie uns bitte unter: acoustics@flexxica.com.

Step into the world of flexxica color palettes

Materials and colors mean everything. Ambience. Atmosphere. Identity. We want to influence and inspire the world of office interiors with our take on materials and colors. Bright and light. Dense and deep. Mix and match our color palettes for any creative design purpose.

Still undecided about which color to choose from our color palettes?

Scan the QR code and look closely at flexxica materials and colors!



We are constantly working on expanding our color palettes with new eco-friendly materials and suppliers that care about the environment as much as we do.

Our current color palettes are always online. Just scan the QR code above!





ARCHI felt ecoPET 12 mm

EN The high-quality PET sound panels are robust, durable, and have a slightly textile surface that can be washed. They have excellent sound-absorbing properties, are flame-resistant and recyclable.

DE Hochwertige PET-Akustikplatten sind massiv, strapazierfähig, mit einer leicht textilen Oberfläche, die gewaschen werden kann. Sie haben hervorragende Schalldämmeigenschaften, sind schwer entflammbar und können recycelt werden.

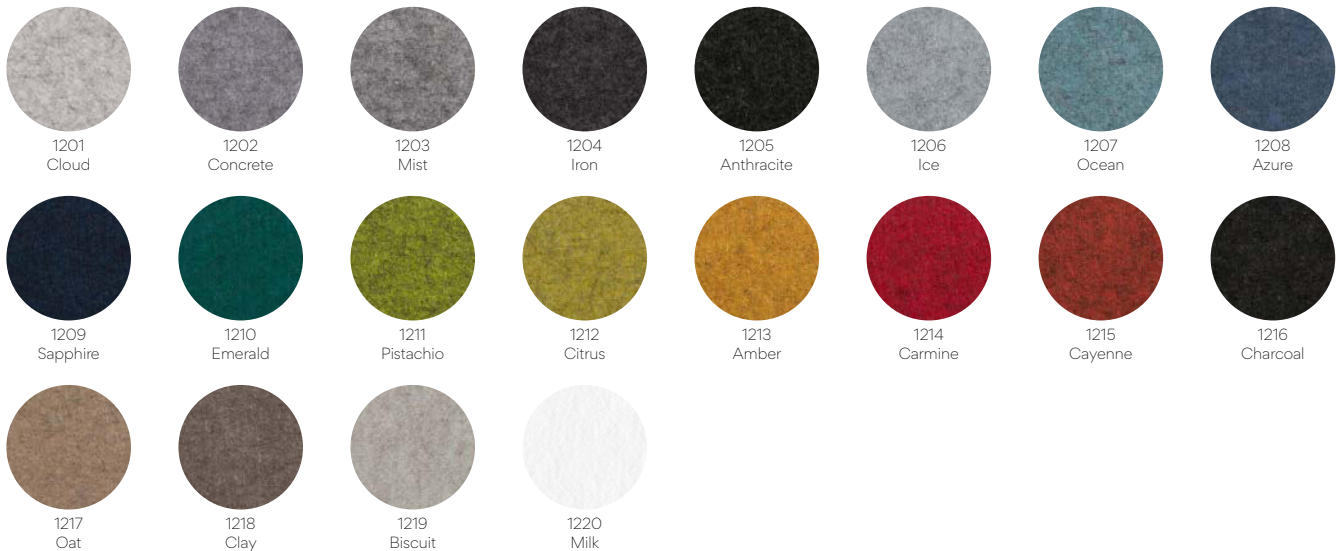

ARCHI felt ecoPET properties

Measurements

2800 mm × 1200 mm × 12 mm

gross size

Flammability Class

B-s1,d0

Acoustic values

Mounting method	Directly on the wall	50 mm cavity	50 mm cavity + 50 mm rockwool	100 mm cavity	100 mm cavity + 100 mm rockwool
NRC (100–5000Hz)	0.40	0.75	0.95	0.80	1.00
aw (100–5000Hz)	0.25	0.60	1.00	0.80	0.95
Acoustic Class	D	C	A	B	A

Flexxica wool felt 5 mm

EN Flexxica wool felt color palette is high-quality 5 mm thick felt. Wool felt has many technical uses, including, among others, in acoustics. The natural properties of wool make this felt not only look designer but also absorb noise and sound perfectly.

DE Die Farbpalette von Flexxica Wollfilz ist hochwertiger 5 mm dicker Filz. Wollfilze haben viele technische Anwendungen, u. a. in der Akustik. Die natürlichen Eigenschaften der Wolle verleihen diesem Filz nicht nur ein Design-Look, sondern auch eine perfekte Dämpfung von Lärm und Geräuschen.



Flexxica felt 5 mm

EN Flexxica felt color palette is a wide range of flame-retardant design felts with a velour finish and high noise reduction properties. They are available in many colors, ideal for many decorative projects, including upholstery and interiors.

DE Die flexxica-Farbpalette für Filze ist eine große Auswahl an schwer entflammaren Designfilzen mit Velours-Finish und hohen Geräuschkürzungsseigenschaften. Sie sind in vielen Farben erhältlich, ideal für viele dekorative Projekte, einschließlich Polsterung und Innenausstattung.

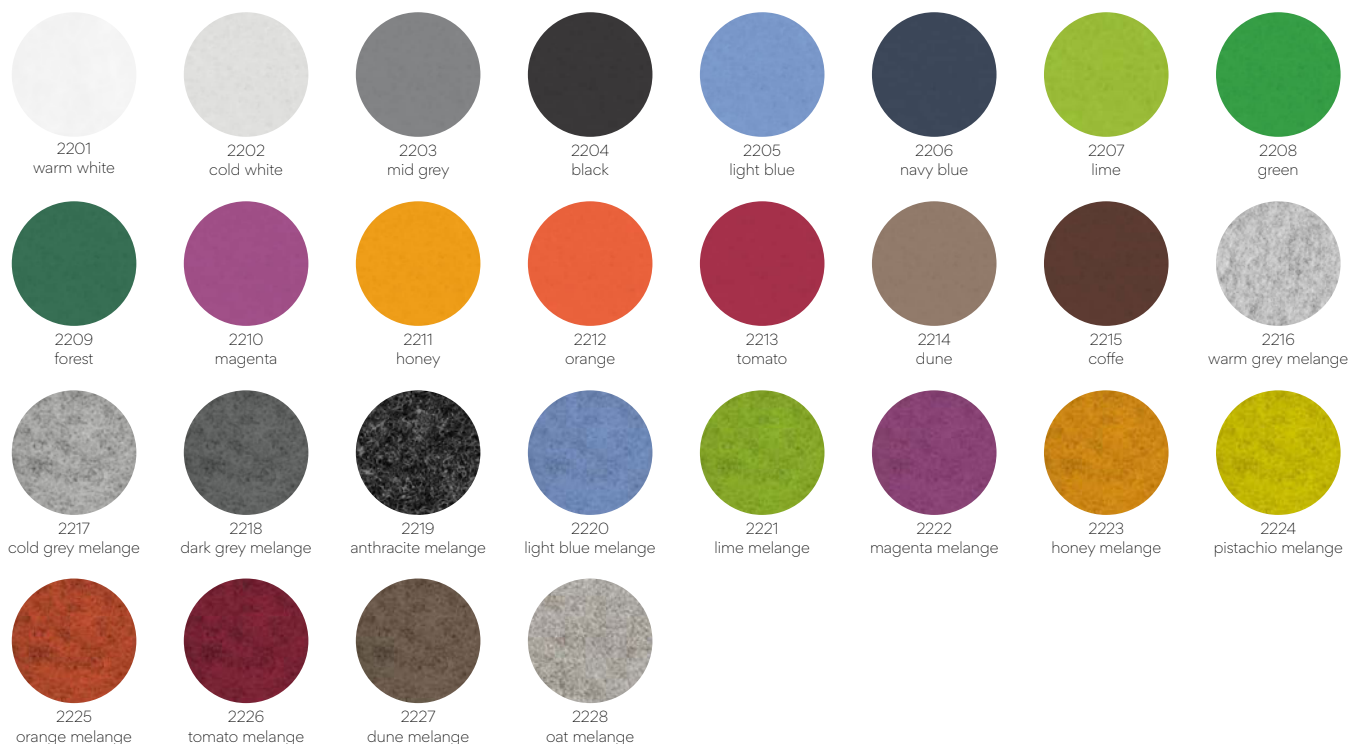

Synergy fabrics by Camira

EN The Camira fabrics color range features 75 shades of Synergy woolen fabric. The fabric is made of the highest quality New Zealand wool and blended only with 5% polyamide. It is very soft, strong, has an impressive wear resistance, and in combination with other materials used in our luminaires, has excellent acoustic characteristics.

DE Die Farbpalette von Camira fabrics umfasst 75 Farbtöne des Synergy-Wollstoffs. Der Stoff ist aus hochwertigster neuseeländischer Wolle gefertigt und mit nur 5% Polyamid verbunden. Es ist sehr weich, stark, hat eine beeindruckende Abriebfestigkeit und hat in Kombination mit anderen Materialien, die in unseren Leuchten verwendet werden, hervorragende akustische Eigenschaften.



Gabriel Chili

EN Chili is a pioneering upholstery fabric distinguished by its fusion of sustainable materials and exceptional fire resistance. Made from 75% post-consumer recycled flame retardant polyester, the fabric sets new environmental standards for fire retardant fabrics. Chili blends unicolored and melange fibers to create a simple yet distinctive two-toned grid design.

DE Chili ist ein wegweisender Bezugsstoff, der sich durch die Verschmelzung nachhaltiger Materialien und außergewöhnlicher Feuerbeständigkeit auszeichnet. Der Stoff besteht zu 75% aus recyceltem, flammhemmendem Polyester und setzt neue Umweltstandards für flammhemmende Stoffe. Chili mischt einfarbige und melierte Fasern, um ein einfaches, aber unverwechselbares zweifarbige Gitterdesign zu schaffen.



Gabriel Medley

EN Medley is woven in 100% polyester melange yarn with a simple, geometric structure. The tight texture and the changing structure of the yarn give the fabric an intense color depth and a lively surface in multiple shades. The weave structure accentuates the richness of every single nuance and creates a discreet color play across the fabric's surface. Nuances fuse gently and with varying saturation and intensity, depending on the incident angle of the light.

DE Medley ist aus 100% Polyester-Mischgarn mit einer einfachen, geometrischen Struktur gewebt. Die straffe Textur und die wechselnde Struktur des Garns verleihen dem Stoff eine intensive Farbtiefe und eine lebendige Oberfläche in mehreren Farbnuancen. Die Webstruktur betont den Reichtum jeder einzelnen Nuance und erzeugt ein dezentes Farbspiel auf der Stoffoberfläche. Je nach Einfallswinkel des Lichts verschmelzen Nuancen sanft und mit unterschiedlicher Sättigung und Intensität.



Gabriel Mica

EN Mica is a cross-functional, two-toned crepe fabric with a graphic yet discreet melange effect. The classic crepe structure is given a contemporary twist, and with its sparkling, crisp, and fresh expression, Mica stands out as an exclusive, sophisticated and updated crepe fabric.

DE Mica ist ein funktionsübergreifender, zweifarbiger Krepptoff mit grafischem und dennoch dezentem Melange-Effekt. Die klassische Krepptstruktur erhält eine zeitgemäße Note, und mit seinem funkelnden, klaren und frischen Ausdruck sticht Mica als exklusiver, raffinierter und aktualisierter Krepptoff hervor.

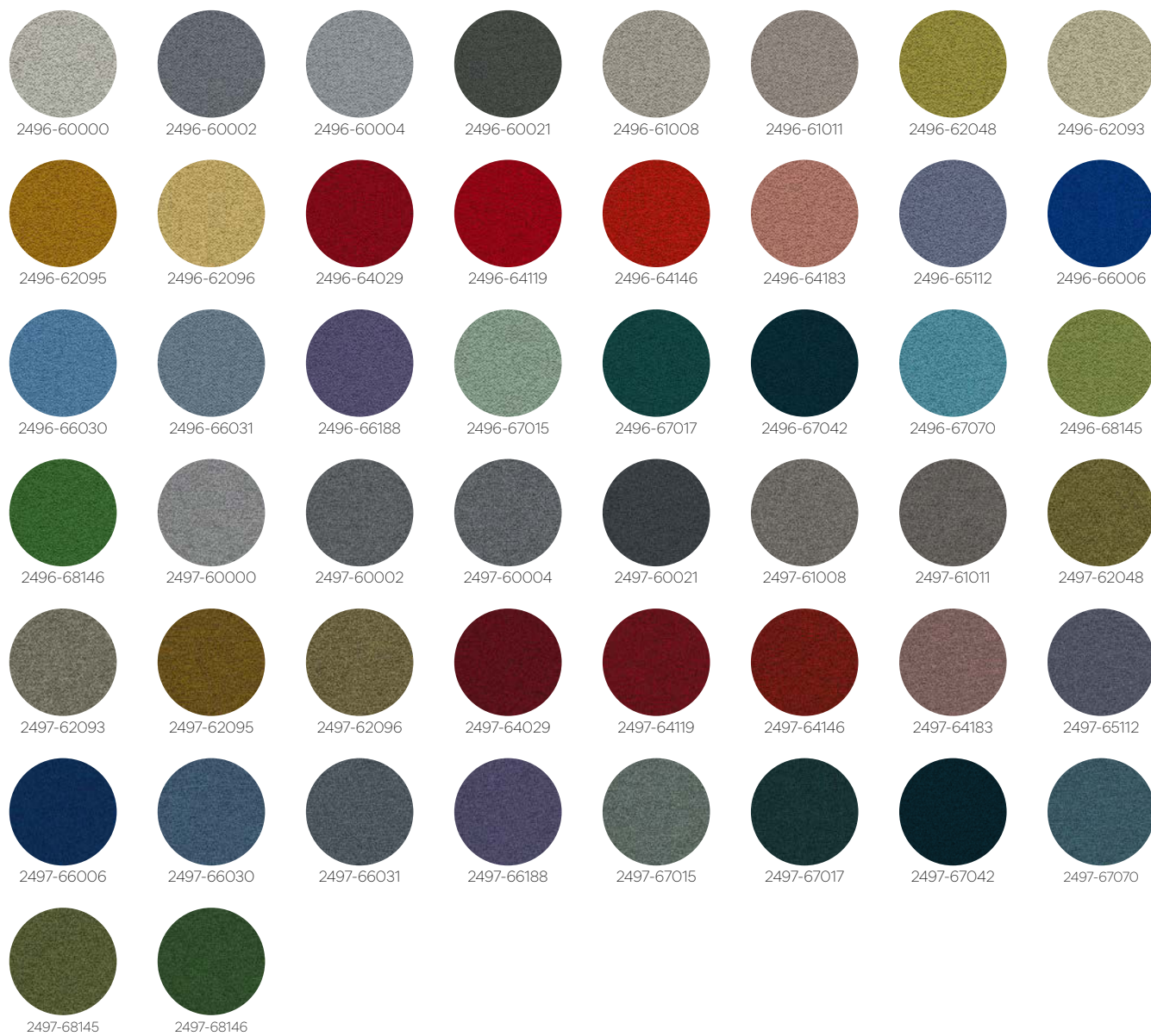

Gabriel Noma

EN Upholstery fabric Noma is distinguished by its attractive, durable, and two-toned melange design, excellent fire resistance, and environmentally friendly. Made from 50% post-consumer recycled flame retardant polyester, Noma is an eco-friendly alternative to standard flame retardant polyester fabrics. It meets all common European fire safety standards.

DE Der Bezugsstoff Noma zeichnet sich durch sein attraktives, strapazierfähiges und zweifarbiges Melange-Design, hervorragende Feuerbeständigkeit und Umweltfreundlichkeit aus. Noma besteht zu 50% aus recyceltem, flammhemmendem Polyester und ist eine umweltfreundliche Alternative zu standardmäßigen flammhemmenden Polyesterstoffen. Es erfüllt alle gängigen europäischen Brandschutznormen.

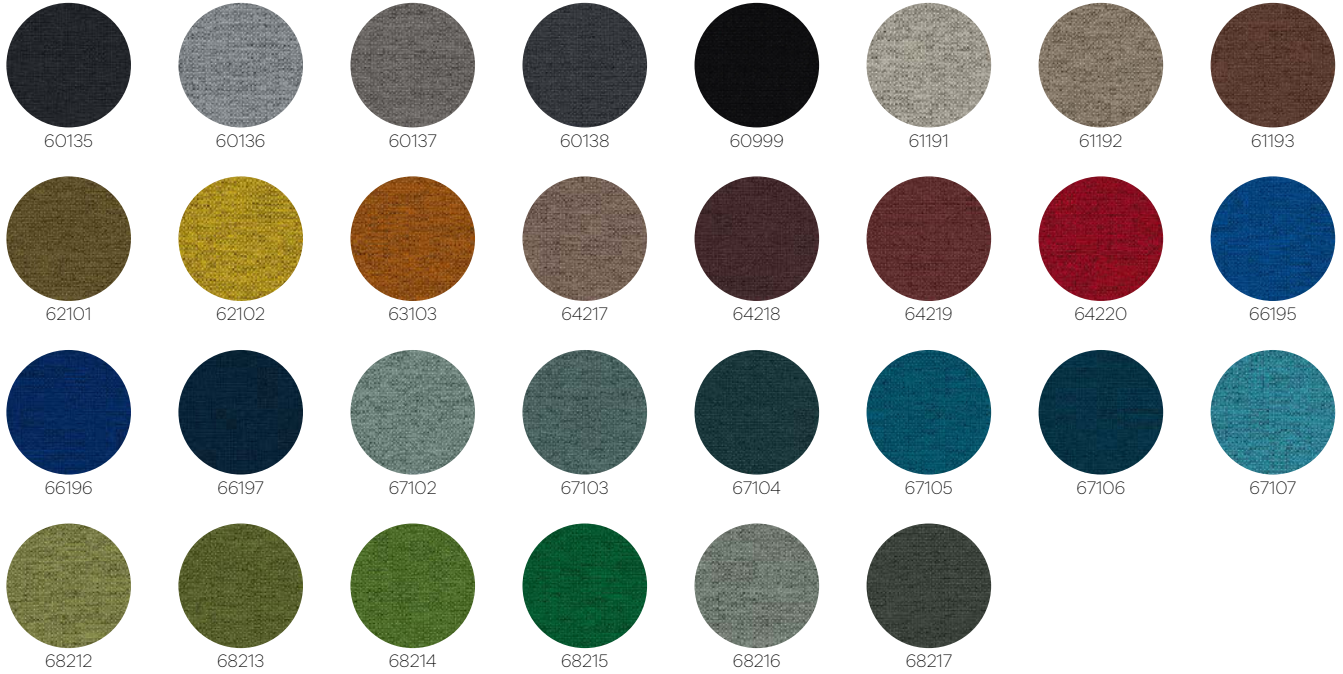

Gabriel Select

EN Select is a classic woolen upholstery fabric distinguished by its underplayed, uncolored elegance and basic, authentic look that exudes sublime craftsmanship and first-class quality. The fabric's tightly woven relief structure adds depth and textural dimension and brings the solid colors to life in a delicate interplay of light and shadow.

DE Select ist ein klassischer Wollbezugsstoff, der sich durch seine unaufdringliche, ungefärbte Eleganz und seinen authentischen, authentischen Look auszeichnet, der höchste Handwerkskunst und erstklassige Qualität ausstrahlt. Die dicht gewebte Reliefstruktur des Stoffes fügt Tiefe und strukturelle Dimension hinzu und erweckt die Unifarben in einem zarten Spiel von Licht und Schatten zum Leben.



Guidelines for cleaning and maintenance of materials used in flexxica luminaires.

To maintain the beautiful color and appearance of flexxica lighting fittings, we recommend gentle vacuuming with a soft tip, preferably weekly.

Stain removal – the golden rule

Remove the stain as soon as possible. Most stains can be removed with lukewarm water, possibly with the addition of a neutral detergent.

Merino wool felt

Wool is antistatic and does not attract dirt like other fabrics. Wool is also water-repellent, so the liquids slowly penetrate the fabric.

Cleaning: First, soak up as much liquid as possible with a white kitchen towel or cloth. If the stain has dried, remove as much as possible with a vacuum cleaner. Wipe carefully with a clean white cloth.

Upholstered material

Upholstery in flexxica luminaires is highly versatile and durable. The material is antistatic and fireproof, so stains are easily removed.

Cleaning: Do not wet the entire lampshade. Always use a clean white cotton cloth and only use small amounts of cleaning agent at a time.

EcoPET material

The ecoPET is made of 60% recycled PET bottles. It is straightforward to maintain, and stains can be removed easily and hassle-free.

Cleaning: Never rub hard to remove a stain. Always use a clean white cotton cloth with a bit of detergent.

Glass luminaires

Boya is made in a traditional blown-glass technology, therefore it requires special and delicate cleaning care.

Cleaning: Use a soft, lint-free microfiber or cotton cloth with distilled water (optimal) or mild glass cleaner or a solution of equal parts water and white vinegar. Wipe carefully with a clean white cloth.

WARNING!

Benzene, acetone, and similar solvent-based products may discolor the materials of the flexxica luminaires. Before use, apply a small amount of the product to an inconspicuous spot to ensure it doesn't cause any damage or discoloration.

flexxica

ul. Szyszkowa 43
02-285 Warsaw
Poland / European Union

+48 723 06 30 30
hello@flexxica.com
flexxica.com

PHOTOGRAPHY

Dominika Rutkowska
Ernest Wińczyk
Fotomohito
Patryk Lewiński
PION Studio
Szymon Polański

Copyright 2024 flexxica®

The flexxica® logo is a national and international registered trademark, held and owned exclusively by PL sp. z o.o. It cannot be reproduced or used, for commercial or other purposes, without the prior written permission of flexxica. This catalog cancels and replaces all previous editions. Flexxica has ensured that the information contained in this catalog is as accurate as possible; however, it declines all responsibility for any printing errors. Flexxica reserves the right to make modifications and improvements of a technical or aesthetic nature to the products at any time without notice. The reproduction (even partial) of this catalog, for any reason and with any means, is prohibited without the prior written permission of flexxica.

Please note that the actual appearance of flexxica's felt and fabric lighting fixtures may vary from the images shown in the catalog. This is because each type of felt and fabric possesses its own distinct characteristics. This is not a disadvantage of the luminaire but an advantage – each product is unique and unrepeatable.

Keep in mind that the colors of PET, felts, and fabric may differ slightly from what you see in the catalog. For the most accurate representation, we recommend referring to our sample book.

Due to the production process of both felt and PET, there may be slight variations in material between different production batches. Additionally, please take into consideration that PET boards have distinct left and right sides, along with a specific fiber arrangement. This is particularly important to consider when installing larger structures, such as wall-mounted panels.

Graphic Design: emenem.pl
Paper: Arctic Volume White 115g
Cover: Color STYLE Recycling 270g
Typeface: Gordita
Printed in Poland

Icons



appliance class I



pendant, light distribution down



pendant, light distribution up & down



pendant, light distribution up



surface



recessed



wall lamp



floor lamp



Ingress Protection Rating 20



Ingress Protection Rating 40



Color Rendering Index 90



Unified Glare Rating <19



Standard Deviation Color Matching 3



adapted to 230V mains voltage



manual electric switch

MOUNTING TYPE	PRODUCT FAMILY	2 ACOUSTIC LIGHTING
1 SURFACE		3 PROFESSIONAL DESIGN
2 PENDANT		5 ACOUSTIC ACCESSORIES
3 PENDANT UP & DOWN		
4 RECESSED WITHOUT FRAME	LIGHTING POWER	1 LOW
5 RECESSED WITH FRAME		2 STANDARD
6 WALL		3 HIGH
7 WALL UP & DOWN	ELECTRICAL CONTROL	9 ON / OFF
8 FLOOR		8 DALI
9 PENDANT UP		7 CASAMBI
	LUMINAIRE COLOR	01 BLACK
		02 WHITE
	COLOR TEMPERATURE	2 2700 K
		3 3000 K
		4 4000 K
		6 6000 K
		9 TUNABLEWHITE

FLEXXICA ACOUSTIC ACCESSORIES

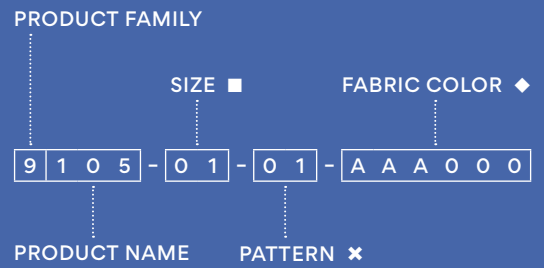

PRODUCT FAMILY	1 TEAM	ELECTRICAL CONTROL	9 ON / OFF
		8 DALI	
PRODUCT NAME	100 STRAIGHT	COLOR TEMPERATURE	3 3000K
	010 ARC	4 4000K	
	001 END	LUMINAIRE COLOR	01 BLACK RAL 9005
CONNECTOR SETS	01 1 CONNECTOR	02 WHITE RAL 9010	
	02 2 CONNECTORS	MOUNTING TYPE	2 PENDANT
	03 3 CONNECTORS		
LIGHTING POWER	2 STANDARD		

		OPTICS		
PRODUCT FAMILY	7 LINE	LINE 28	1 OPAL	LIGHTING POWER
			2 MICROPRISMATIC	2 STANDARD
PRODUCT NAME	1 LINE 28		3 DARK OPTIC 65°	3 HIGH
	2 LINE 43		4 DARK OPTIC 55°	
	4 LINE 30 OVAL		8 JET OUT	ELECTRICAL CONTROL
	5 LINE 28 DOT SYSTEM		9 BLIND COVER	9 ON / OFF
		LINE 43	1 OPAL	8 DALI
MOUNTING TYPE	1 SURFACE		2 MICROPRISMATIC	COLOR TEMPERATURE
	2 PENDANT		3 DARK OPTIC 80°	3 3000K
	3 PENDANT UP & DOWN		4 DARK OPTIC 50°	4 4000K
			5 DARK OPTIC 30°	9 TUNABLE WHITE
			6 DARK OPAL	LUMINAIRE COLOR
			7 WALL WASHER	01 BLACK RAL 9005
			9 BLIND COVER	02 WHITE RAL 9010
		LINE 30	1 OPAL	REFLECTOR COLOR
			2 MICROPRISMATIC	01 BLACK MATTE
			3 DARK OPTIC 65°	02 WHITE MATTE
			4 DARK OPTIC 55°	04 SILVER MATTE
			9 BLIND COVER	05 GOLD MATTE

FLEXXICA LUMINAIRES

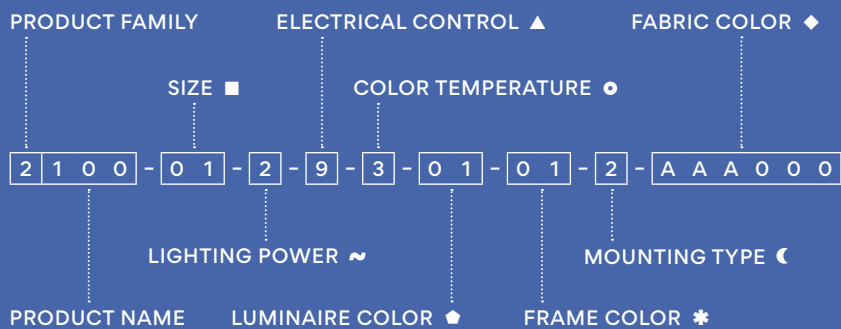

FLEXXICA TEAM SYSTEM page 170

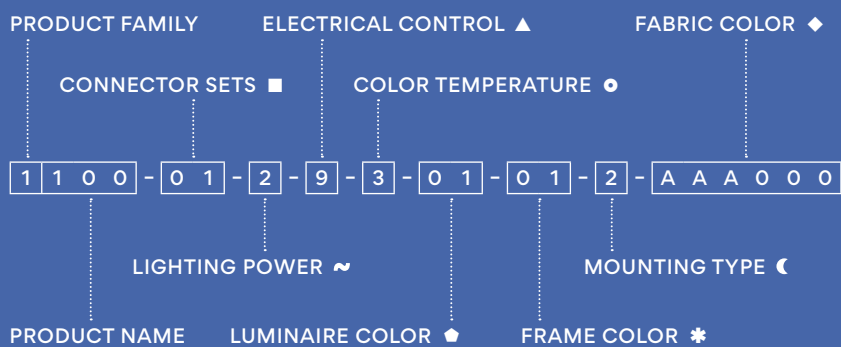

FLEXXICA LINE

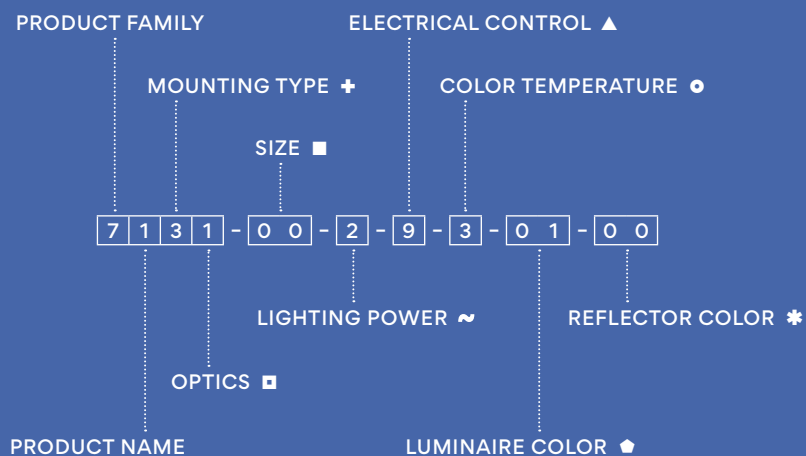

fluora.ch
INDIVIDUELLE LICHTLÖSUNGEN

Fluora Licht AG
Waldau 1
CH - 9230 Flawil
+41 71 511 39 10
licht@fluora.ch

Fluora Licht AG
Waldeggstrasse 47
CH - 3097 Liebefeld/Bern
+41 31 915 50 50
verkauf.be@fluora.ch

www.fluora.ch